

89- HQ-4286

SECTION 1

SECTION 1
SERIALS X--100

SERIALS X-100

C-097

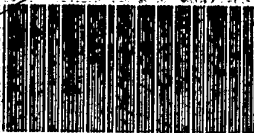

U. S. Department of Justice

MATERIAL MUST NOT BE REMOVED FROM OR RETURNED TO THIS OFFICE

9/1/82
#248,125
#248,126

FEDERAL BUREAU

of

INVESTIGATION

DO NOT
DESTROY
FOIPA # 1164234

USE CARE IN HANDLING THIS FILE

Transfer-Call 3421

Mr. William Wilson
Director of FBI
U.S. Department of Justice
Washington, D.C.

ALL INFORMATION CONTAINED

HEREIN IS UNCLASSIFIED

DATE 7/17/92 BY 10480 DML/wda

#284126 & 284125

OUTSIDE SOURCE

October 14, 1978

JK
Dear Sir,

Leo Ryan

I have watched in horror as the truth has been revealed about the FBI and the Panthers, the FBI & Scientology, the FBI + Martin Luther King, the FBI and Mrs. E. Howard Hunt, etc, etc. Apparently the FBI thinks it can get away with anything. If the FBI is intent on a new victim, the Peoples Temple, I think I think) could happen. The wrath of the people would finally be awakened or the Constitution might just as well be burned. The people have learned to much. If we continue to accept these violations on our rights we might as well cancel out democracy. I don't think we're ready for that.

89-4286-X

DE-51

22 DEC 12 1978

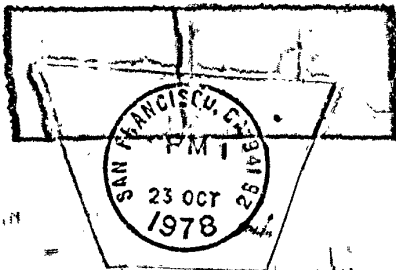

AMS
ANT

yours truly

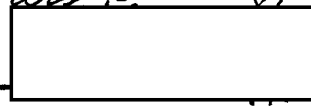

b6
b7c

Unable to ack
No return address

Bufiles NF

NO LOC

CORRESPONDENCE

Referred to SF for handling
by Bufile 11-27-78 (89-4286-573)

RDS
6

Pls. file 6 DEC 20 1978

89-4286

October 14, 1978

ask
3

FEDERAL BUR. OF INV.

Dear Mr. Bell,

OUTSIDE SOURCE

Leo Ryan

ALL INFORMATION CONTAINED
HEREIN IS UNCLASSIFIED
DATE 9/17/92 BY SP8 DCP/MLB

There is a certain unsavory character named Timothy O. Stoen who acted as legal counsel for the Peoples Temple in California for a number of years and then went crazy on the Temple because he wasn't man enough to stand with their leader through thick and thin. He is apparently attempting to use the FBI to attack the Temple and some others are working with him. It would be an outrage to the taxpayers if these crackpots succeed in pulling the FBI into this plot.

Referred to SF for handling
by Bu a/t 11.27.78 (89-4286-573)

Pls. file in
89-4286

DE-511
REC-129

89-4286

Sincerely,

[Redacted signature box]

DEPT OF JUSTICE
OFFICE OF THE ATTORNEY GENERAL
OFFICE OF INVESTIGATION AND FINANCE
DEC 30 11 39 AM '78

22 DEC 12 1978

b6
b7c

San Francisco, Ca.

[Redacted return address box]

Unable to Ack
No return address

CONFIDENTIAL

NOV 20 1978

ask
3

10-1978

10-21-78

Leo Ryan

Mr. William Webster, Director
FBI U.S. Department of Justice

ALL INFORMATION CONTAINED
HEREIN IS UNCLASSIFIED
DATE 9/17/92 BY 1048 DM/MLC
OUTSIDE SOURCE

I find it difficult to believe that your agency could recklessly allow itself to be the tool of such a Base individuals as Jim O Stoen and some whom he has in his paw. It has become known to us that the FBI is again targeting P.T. For what now? Have we not satisfied the agency of our reputability and integrity? How can you fire up another investigation on the most fallacious and contrived accusers? One look at Mr. Stoen's situation should convince you that he has a vested interest in keeping anti-P.T. campaign alive. He has in short, staked his own reputation on the downfall of the Temple. It appears that he sees his sole function in life to be the discrediting of a great man and a great organization.

In psychology there is ^{DE-51} something called the love-hate syndrome, which affects certain individuals. When they love something, it encompasses all aspects of their life and they are totally enthralled with it. Then when love turns to hate, the some individuals thrive solely on the destruction of that which he loved. How clearly I remember Mr. Stoen saying approximately 1 year ago how extraordinary Jim Jones's character was, how much courage and honesty he had. He said it with apparent sincerity. Now look. The same man is a ranting maniac bent on alienating all support for the Temple and bent on destruction. But Jim Stoen is the proverbial dog baying at the moon.

DEC 12 1978

66-21-118
11-21-78
Report for handling by
11-27-78 (57-4286-573)
P.L. 11-27-78 57-4286

Chin...

The FBI is under new direction. The scourge of J E Hoover should not be re-lived. Do not become the vehicle of reactionary elements that attempt to discredit and destroy groups that are oriented toward true human service work. Why should a group which has drug rehabilitation, college scholarships, senior citizen programs etc. be subjected to harassment and attempts to destroy it? That infamous "Credibility gap" which threatens to serve the Agency from the American people has reared its ugly head again.

Mr. Griffith Bell
U. S. Attorney General
U. S. Dept. of Justice
Washington, D. C.
[Redacted]

Sincerely
[Redacted]

Mr. William Webster, Director
FBI U.S. Department of Justice
Washington, D.C.
[Redacted]

U.S.A.
[Redacted]

b6
b7c

10/21/78

Mr. William Webster
Director of FBI
U.S. Department of Justice
Washington, D.C.

OUTSIDE SOURCE

ALL INFORMATION CONTAINED
HEREIN IS UNCLASSIFIED
DATE 9/17/92 BY 1642 xim/kdm

Leo Ryan

Air:

I personally believe there is
an invisible government threatening
the rights of the American people.
If the FBI created any trouble
for People's Temple, many more
Americans will agree with me.

(JLD)

Sincerely,

[Redacted]

[Redacted]

- 4286 - 473

b6
b7c

No act
necessary
11-21-78
Dist.

DE-51 REC-129

22 DEC 12 1978

REB

CORRESPONDENCE

66 DEC 20 1978



b6
b7c



SERVING AMERICA

UNITED STATES POSTAL SERVICE

ALL INFORMATION CONTAINED
HEREIN IS UNCLASSIFIED
DATE 9/17/92 BY 1048 DEM/ack

Mr. William Webster
Director of FBI
U.S. Department of Justice
Washington, D.C.

FEDERAL BU. OF INV. ² (17) ²/₂

William
Mr. Griffin Bell
U.S. Attorney General
U.S. Department of Justice
Washington, D.C.

10-21-78

ALL INFORMATION CONTAINED
HEREIN IS UNCLASSIFIED
DATE 9/17/82 BY 10480A

m/rdm

Sir:

I personally believe there is an
invisible government threatening the
rights of the American people. If the
FBI created any trouble for People's
Temple, many more Americans will
agree with me.

Sincerely,

b6
b7c

no act necessary
11-21-78
Referred to SF for handling by
Buck 11-27-78 (89-4286-573)
pls. file 89-4286

RD
6

~~CONFIDENTIAL~~
~~CONFIDENTIAL~~
~~CONFIDENTIAL~~
CORRESPONDENCE

File with 89-4286-X3



UNITED STATES POSTAL SERVICE 15c

b6
b7c

ALL INFORMATION CONTAINED
HEREIN IS UNCLASSIFIED
DATE 9/7/92 BY 1048 OKM/rdm

Mr. Griffith Bell
U.S. Attorney General
U.S. Department of Justice
Washington, D.C.

Mr. H. M. Webster, Director
Federal Bureau of Investigation
U.S. Dept. of Justice
Washington, D.C.

10/17/78

ALL INFORMATION CONTAINED
HEREIN IS UNCLASSIFIED
DATE 1/17/92 BY 1046 DCM/KDM
OUTSIDE

Dear Sir: LEO RYAN

I understand another complaint is
being filed against Peoples Temple
and this Com totally against! I
think it would be biased, unjust and
completely anti-democratic to attack
this church and its minister with
another investigation. They have been
harrassed enough! I don't think this much
investigation was given to Watergate.

To pursue attacking these people
will really prove how low justice has
fallen.

DE-51 89-4286-X4

To me, and I'm sure, many others, this
church has, and is still doing, more
humanitarian work than any other church.

It's too bad the character of the conspirators
isn't being investigated so thoroughly. If
this can't be done any idea of investigating
Peoples Temple ought to be dropped.

DEC 12 1978

Can't anyone ever do good here in the
U.S. without being harassed, conspired against,
or murdered? Please let these people
live in peace.

CORRESPONDENCE

[Redacted signature area]
[Redacted date area] 11-20-1978
[Redacted name area] James Swanson

b6
b7c

ALL IN
HERE!
DATE-

no ack
11-21-78
JMT

Referred to SF for handling
by Buatt 11-27-78 (89-4286-52)
RDE
Pls. file in 89-4286



b6
b7C



GUYANA 50
MOVE
FORWARD



Mr. Wm. Webster,
Director
Federal Bureau of Investigation
U. S. Dept. of Justice
Washington, D. C.
U.S.A.

INFORMATION CONTAINED
HEREIN IS UNCLASSIFIED
DATE 11/2/82 BY 108 OKM/ndc

UNITED STATES GOVERNMENT

UNITED STATES DEPARTMENT OF JUSTICE
FEDERAL BUREAU OF INVESTIGATION

Memorandum

Assoc. Dir. _____
 Dep. AD Adm. _____
 Dep. AD Inv. _____
 Asst. Dir.:
 Adm. Servs. VMS
 Crim. Inv. VMS
 Ident. _____
 Intell. _____
 Laboratory _____
 Legal Coun. _____
 Plan. & Insp. _____
 Rec. Mgnt. _____
 Tech. Servs. _____
 Training _____
 Public Affs. Off. _____
 Telephone Rm. _____
 Director's Sec'y _____

TO : MRL MOORE DWM RM (89-)

DATE: 11/18/78

FROM : [Redacted] [Signature]

ALL INFORMATION CONTAINED
HEREIN IS UNCLASSIFIED
DATE 9/17/92 BY 1048 DCH/ndm

SUBJECT: UNKNOWN SUBJECTS;
REP. LEO RYAN (CALIF.) - VICTIM;
POSSIBLE ASSASSINATION

9
[Redacted]

b6
b7C

See

On 11/18/78, at 8:30 pm, Special Agent [Redacted] Department of State, Washington, D. C., telephonically advised the writer that he had "flash" information from the American embassy in the African country of Guyana that the above captioned individual while boarding a small airplane along with approximately 8 to 10 other individuals were attacked by a truck-load of "whites."

[Redacted] stated that as of this time the information regarding RYAN's demise was unsubstantiated.

W. H. ARENDT, Personal Crimes Unit, was advised of the above information. (u)

(u)

See index

REC-115

DE-5

N 89 - 4286 - 1

24 NOV 21 1978

[Signature]
csr

[Signature]



58 NOV 29 1978

Buy U.S. Savings Bonds Regularly on the Payroll Savings Plan

FBI/DOJ

TO TAPE

031

*A [initials]
P [initials]*

MESSAGE RELAY VIA TELETYPE

Date 11/20/78

PRECEDENCE: IMMEDIATE
 PRIORITY
 ROUTINE

CLASSIFICATION: TOP SECRET
 SECRET
 CONFIDENTIAL
 UNCLASSIFIED

FIELD AND LEGAT MESSAGES ONLY CLEAR EFTO

FM: DIRECTOR
TO: SAN FRANCISCO
MIAMI

B

*DECLASSIFIED BY 1048 DKM/mdm
ON 9/17/92*

- Attorney General
- Deputy Attorney General
 - Attn: Emergency Programs Center
- Assistant Attorney General, Civil Rights Div.
- Assistant Attorney General, Criminal Div.
 - Attn: Internal Security Section
 - Attn: General Crimes Section
- Immigration and Naturalization Service
- U. S. Marshal's Service
- U. S. Secret Service (PID)
- Director, CIA
- Secretary of State
- Department of Treasury
 - Attn: U. S. Customs
- Department of Treasury
 - Attn: Bureau of Alcohol Tobacco & Firearms

- Drug Enforcement Administration
- Energy Research and Development Administration
- U. S. Postal Service
- National Aeronautics & Space Adm.
- Department of Transportation
 - Attn: Director of Security
- Federal Aviation Administration
- Department of the Air Force (AFOSI)
- Department of the Army
- Naval Investigative Service
- National Security Agency (DIRNSA/NSOC (Attn: SOO))
- Commandant, U. S. Coast Guard
- Director, Defense Intelligence Agency

- The President
- White House Situation Room
 - Attn:
- The Vice President
 - Attn:

9
(circled)

(SUBJECT (TEXT BEGINS NEXT PAGE):

RYMUR.

V-1 DE-50

ST-103

REC-9

89-4286-2

Foreign Liaison Unit

- Route through for review
- Cleared telephonically with _____

b6
b7c

- Assoc. Dir. _____
- Dep. AD Adm. _____
- Dep. AD Inv. _____
- Asst. Dir.: _____
- Adm. Servs. _____
- Ident. _____
- Intell. _____
- Laboratory _____
- Legal Coun. _____
- Plan. & Insp. _____
- Rec. Mgnt. _____
- Tech. Servs. _____
- Training _____
- Public Affs. Off. _____
- Telephone Rm. _____
- Director's Sec'y. _____

LEO J. RYAN

Leo Ryan

ORIGINATOR LFS RM 4052 EXT 4661

FEDERAL BUREAU OF INVESTIGATION
COMMUNICATIONS SECTION

NOV 21 1978

TELETYPE

MAIL ROOM

✓ DWIM/LFS

11 NOV 21 1978

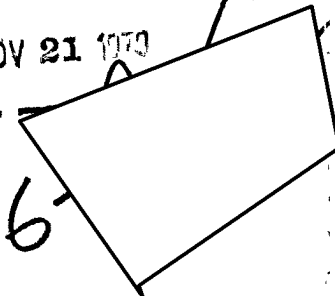

CONFIDENTIAL

FBB137

Assoc. Dir.	
Dep. AD Adm.	
Dep. AD Inv.	
Asst. Dir.:	
Adm. Serv.	
Crim. Inv.	
Ident.	
Intell.	
Laboratory	
Legal Coun.	
Plan. & Insp.	
Rec. Mgmt.	
Tech. Servs.	
Training	
Public Affs. Off.	
Telephone Rm.	
Director's Sec'y	

PAGE 01
ACTION L-03

GEORGE 03816 202214Z

20 Nov 78 23 18z

INFO OCT-01 ARA-11 ISO-00 JUSE-00 SSO-00 COMMUNICATIONS SECTION SCS-00
 CA-01 SS-15 FBIE-00 NSCE-00 SY-05 CIAE-00 INF-00
 NSAE-00 INRE-00 USSS-00 PA-01 CG-00 DOTE-00 COO-00
 AID-05 MCT-02 TRSE-00 ICAE-00 SYE-00 /061 W

-----101747 202229Z /66

Z 0 202120Z NOV 78

FM AMEMBASSY GEORGETOWN
TO SECSTATE WASHDC FLASH 8105
INFO AMEMBASSY CARACAS IMMEDIATE

ALL INFORMATION CONTAINED
HEREIN IS UNCLASSIFIED
DATE 11/21/92 BY 1048 DCM/udal

b6 per FBI
b7c

~~CONFIDENTIAL~~ GEORGETOWN 3816

CARACAS FOR LEGATT

REF: STATE 293787

STATE DEPARTMENT HAS ADVISED AS FOLLOWS:

1. EMBASSY OFFICER DISCUSSED PARA 4 REFTEL ASSISTANCE OFFER WITH GOG COMMISSIONER OF NATIONAL POLICE (NP) LLOYD BARKER, AND MADE

ADDITIONAL POINTS OUTLINE IN PARA 5 REFTEL. BARKER WAS MOST APPRECIATIVE OF USG OFFER AND EXPRESSED WILLINGNESS TO RECEIVE CARACAS LEGATT. BARKER'S MAIN CONCERN AT THIS POINT IS THE NARROW SPAN OF TIME AVAILABLE FOR REMOVING BODIES FROM JONESTOWN, IDENTIFYING

THEM, AND CONDUCTING POST-MORTEMS ON RANDOM SAMPLES OF THEM. HE WAS

ALSO GREATLY CONCERNED ABOUT THE JONESTOWN SURVIVORS STILL IN THE JUNGLE WHO HE CLASSIFIED INTO TWO GROUPS: PEOPLE ON THE RUN WITH ONLY SURVIVAL IN-MIND; AND HARD CORE FOLLOWERS OF REV JAMES JONES

WHO INTENDED TO MAKE A LAST STAND AGAINST SECURITY FORCES PURSUING THEM. BARKER POINTED OUT THE OBVIOUS NEED TO LOCATE AND ASSIST THE FIRST GROUP AND THE NECESSITY FOR LOCATING AND CONFRONTING THE

SECOND. HE THEN OUTLINED HIS PLANS AND COUCHED HIS NEEDS IN TERMS OF THE ABOVE REQUIREMENTS.

2. AS TO THE EVACUATION OF BODIES, BARKER STRESSED THE URGENCY OF A LARGE-SCALE EFFORT TO QUICKLY PREPARE THESE BODIES FOR REMOVAL.

CONFIDENTIAL

~~CONFIDENTIAL~~

CONFIDENTIAL

PAGE 02

GEORGE 03816 202214Z

~~CONFIDENTIAL~~

HE WAS NOT AWARE OF THE POSSIBILITY OF HAVING IN-COUNTRY A U.S. GRAVES REGISTRATION TEAM AND THE CONTRIBUTION THEY COULD MAKE TO ORDERLY AND SPEEDY EVACUATION. BAKER SENT SEVERAL JONESTOWN

ESCAPEES BACK TO JONESTOWN WITH A SIX-MAN POLICE TEAM TO HELP IDENTIFY MURDER/SUICIDE VICTIMS. TWO PHOTOGRAPHERS AND TWO FINGERPRINT TECHNICIANS ARE PRESENT TO ASSIST IN THE IDENTIFICATION

PROCESS. POLICE PLAN TO SEPARATE THE BODIES INTO TWO GROUPS FOR INVESTIGATIVE PURPOSES: THOSE WHO WERE POISONED AND THOSE WHO DIED OF GUNSHOT WOUNDS. POLICE WILL TAKE APPROXIMATELY THREE

P3 BODIES FROM EACH GROUP FOR POST-MORTEM EXAMS TO BE CONDUCTED ON-SITE AT THE JONETOWN MEDICAL FACILITY. POLICE WILL FOCUS ON

CONSPIRACY RATHER THAN TRY TO DEVELOP SEPARATE MURDER CASES FOR

EACH VICTIM. IN THIS LIGHT, A CURIOUS GUYANESE LAW OF EVIDENCE PREVAILS WHICH HAS IMPORTANT IMPLICATIONS: A CANDIDATE FOR POST-

MORTEM MUST BE IDENTIFIED BY A CLOSE RELATIVE OR A PERSON

WHO HAS KNOWN THE CANDIDATE FOR SEVERAL YEARS: LATER, THE POLICE INVESTIGATOR WHO IS PRESENT AT THE POST MORTEM MUST ACCOMPANY

THE BODY TO ITS FINAL RESTING PLACE AND WITNESS ITS BURIAL.

BARKER SAID THAT POLICE ARE WILLING TO USE JONESTOWN ESCAPEES TO IDENTIFY THE BODIES BUT MAY BE OBLIGED TO INSIST ON POLICE

INVESTIGATORS ACCOMPANYING THE BODIES TO THE US FOR BURIAL

ONCE THE POST MORTEM IS COMPLETED. BARKER STATED A WILLINGNESS TO DEVIATE FROM THE CONSPIRACY APPROACH TO PROSECUTION SHOULD

WITNESS STATEMENTS GIVE PROMISE OF DEVELOPING A GOOD INDIVIDUAL

MURDER CASE. CONSPIRACY TO MURDER, BY THE WAY, CARRIES A MAXIMUM OF SEVEN YEARS IMPRISONMENT.

3. BARKER SUGGESTED THAT THE TASK FORCE AT JONESTOWN BE BROKEN DOWN INTO TWO GROUPS: ONE GROUP TO IDENTIFY AND EXFIL BODIES,

P4 AND A SECOND GROUP TO CONCENTRATE ON SEARCH AND RESCUE. HE

RECOMMENDED THAT 10 HELICOPTORS BE EMPLOYED IN EVACUATING

BODIES WHILE TWO ARE BEING USED IN SEARCH AND RESCUE OPERATIONS.

ONCE THE EXFIL OF BODIES IS COMPLETED, THE REMAINING 10 HELICOPTORS

~~CONFIDENTIAL~~

~~CONFIDENTIAL~~

3

~~CONFIDENTIAL~~

CAN BE UTILIZED IN SEARCH AND RESCUE OPERATIONS. WHILE BEING SYMPATHETIC TO THOSE JONESTOWN ESCAPEES WHO ARE MERELY TRYING TO SURVIVE IN THE JUNGLE, BARKER IS ALSO CONVINCED THAT THE HARD-CORE ELEMENT RESPONSIBLE FOR CODEL'S DEATH WILL MAKE A LAST STAND AND PERHAPS EXACT CASUALTIES AMONG GOG FORCES.

4. THE FOLLOWING ARE ADDITIONAL NEEDS OF THE NP IN INVESTIGATIVE FIELD AS WELL AS FOR SEARCH AND RESCUE OPERATIONS:

- ✓ 5- POLAROID INSTANT CAMERAS AND FILM
 - ✓ 7- FINGERPRINT KITS
 - ✓ 200- FLASHLIGHTS WITH BATTERIES
 - ✓ 200- PONCHOS
 - ✓ 200- CANTEENS, CANTEEN CUPS, AND CANVAS BELT WEBBING
 - ✓ 200- MESS KITS
- PSYCHOLOGICAL STUDIES ON RADICAL US RELIGIOUS GROUPS WHICH HELP TO EXPLAIN THEIR BEHAVIOR.

✓ ASSISTANCE WITH PACKAGING EVIDENCE FOR EXAMINATION IN US LABORATORIES IF NOT THE PRESENCE OF US BALLISTICS EXPERT IN GUYANA.

✓ LOAN OF A FORENSIC EXPERT TO ASSIST IN THE INVESTIGATION. THE CONTINUE PRESENCE OF A US PATHOLOGIST UNTIL INVESTIGATION IS COMPLETED.

ALL EQUIPMENT DESTINED FOR NATIONAL POLICE SHOULD BE CLEARLY MARKED TO PREVENT ACQUISITION OF IT BY GDF.

5. DURING THE INTERVIEW, BARKER EMPHASIZED THAT THE MAGNITUDE OF THE INVESTIGATION WAS NOT RELATED TO THE NUMBER OF PEOPLE WHO HAD DIED. HE WELCOMED THE PRESENCE OF CARACAS LEGAL ATTACHES FOR CONSULTATION AND ADVISORY PURPOSES BUT DOUBTED THAT THEY WOULD BE NEEDED FOR TAKING STATEMENTS. HE ALSO WELCOMED THE OFFER OF INVESTIGATORY HELP IN THE US ON ACTIVITIES THAT ARE US-CONNECTED. WHEREAS HE APPRECIATED THAT THIS WAS A CRIME AMONG US CITIZENS COMMITTED ON GUAYANESE TERRITORY, HE WAS ALSO ANXIOUS TO CONDUCT THE MOST OBJECTIVE AND PROFESSIONAL INVESTIGATION POSSIBLE UNDER THE CIRCUMSTANCES.

~~CONFIDENTIAL~~

~~CONFIDENTIAL~~

PAGE 04

GEORGE 03816 202214Z

IT IS DOUBTFUL THAT BARKER WOULD FAVOR EXTRADITION OR EXPULSION
OF US PERSONS RESPONSIBLE, ALTHOUGH IT MIGHT BE POSSIBLE TO
TURN HIM AROUND ON THE MATTER. HOWEVER THAT MAY BE, BARKER WOULD
BE THE LEAST OF OUR WORRIES WHEN COMPARED TO THE PRIME MINISTER
HIMSELF AND THOSE HIGH-RANKING MINISTERS CLOSEST TO THE PM.
WE ARE NOT SANGUINE THAT GOG WOULD ENTERTAIN SUCH A SUGGESTION
AND , IN FACT, MIGHT MAKE AN ISSUE OF IT WHEN IT SUITED THEIR

PURPOSE.

b6 per FBI
b7c

FOR INFORMATION SAC, MIAMI, THE FBI WILL SUPPLY SA

FBI LAB TO SERVICE GUYANA'S REQUEST FOR BALLISTICS AND
FORENSIC EXPERT. PHOTO EQUIPMENT AND FINGERPRINT KITS SHOULD
BE PROVIDED BY MAIMI OFFICE ~~XXX~~ INSURING STRICT INVENTORY AND
PHYSICAL CONTROL. SAN FRANCISCO ADVISED FOR INFORMATION. (u)

BT

CLASSIFIED BY 6693, XGDS 2 AND 3, INDEFINITE

~~CONFIDENTIAL~~

S

LIMITED OFFICIAL USE

FBB027

19 NOV 78 04 00Z

Assoc. Dir.	_____
Dep. AD Adm.	_____
Dep. AD Inv.	_____
Asst. Dir.:	_____
Adm. Serv.	_____
Crim. Inv.	_____
Ident.	_____
Intell.	<u>Wooters</u>
Laboratory	_____
Legal Coun.	_____
Plan. & Insp.	_____
Rec. Mgmt.	_____
Tech. Servs.	_____
Training	_____
Public Affs. Off.	_____
Telephone Rm.	_____
Director's Sec'y	_____

PAGE 01
ACTION ARA-15

GEORGE 03777
COMMUNICATIONS SECTION

FEDERAL BUREAU OF INVESTIGATION

INFO OCT-01 ISO-00 H-01 SS-15 NSCE-00 SSO-00 CIAE-00
 DODE-00 PA-01 JUSE-00 TRSE-00 SCS-06 CA-01 MCT-02
 INR-10 INRE-00 SY-05 USSS-00 AID-05 SYE-00 CCO-00
 (AS-01, FBIE-00,) W

ALL INFORMATION CONTAINED
 HEREIN IS UNCLASSIFIED
 DATE 9/19/92 BY 10480KM/ndm

Z 190330Z NOV 78

FM AMEMBASSY GEORGETOWN
TO SECSTATE WASHDC FLASH 8064

FEDERAL GOVERNMENT

ORYMUR

[Redacted box]

LIMITED OFFICIAL USE GEORGETOWN 3777

89-4286-3

REC-129

22 NOV 24 1978

b6 per FE
b7c

E.O. 11652: NA

TAGS: CASC, OREP(RYAN, LEO) GY

SUBJ: CODEL RYAN: BACKGROUND PORT KAITUMA AND JONESTOWN.

REF: GEORGETOWN 3774.

RM 506
6-

1. PORT KAITUMA AIRSTRIP IS A VERY SHORT RUDIMENTARY LANDING AREA WITHOUT NAVIGATIONAL AIDS, RADIO, OR LANDING LIGHTS.

2. AREA IS VERY INACCESSIBLE BY ANY OTHER MEANS OF TRANSPORTATION; THERE BEING ONLY JUNGLE TRAILS AND EXTREMELY ROUGH

ROAD BETWEEN AIRSTRIP AND JONESTOWN, SITE OF PEOPLE'S TEMPLE COMMUNE AND AGRICULTURAL PROJECT.

58 NOV 28 1978

3. THERE ARE NO OTHER NEARBY LANDING AREAS CAPABLE OF
TAKING MILITARY AIRCRAFT SUCH AS C-123 OR C-130. NEAREST U.S.
MILITARY FACILITY IS EITHER PANAMA OR PUERTO RICO,
APPROXIMATELY 6 HOURS FLYING TIME FROM GUYANA.

4. PORT KAITUMA AIRSTRIP IS SURROUNDED BY DENSE, ROUGH
JUNGLE AND ANY RESCUE OR ASSAULT OPERATION WOULD REQUIRE
AIRBORNE CAPABILITY. CHART COORDINATES ARE 7 DEGREES
45 MINUTES NORTH AND 59 DEGREES 45 MINUTES WEST.

LIMITED OFFICIAL USE

LIMITED OFFICIAL USE

PAGE 02

GEORGE 03777 190330Z

5. MATTHEWS RIDGE TO WHICH GOG IS SENDING GDF
SECURITY FORCE IS 20 MILES SOUTHWEST PORT KAITUMA
ACROSS BARIMA RIVER AT COORDINATES 7 DEGREES
30 MINUTES NORTH, 60 DEGREES 10 MINUTES WEST. THIS
AREA ALSO EXTREMELY DIFFICULT TERRAIN WITH TRAILS
EXTENDING THROUGH VERY DENSE JUNGLE.

6. ANY NIGHT OPERATION WOULD REQUIRE FLARES TO LIGHT
UP LANDING AREA AT PORT KAITUMA. 2

7. RE PARA 2 ABOVE, PORT KAITUMA AS WELL AS ACTUAL
SITE JONESTOWN AGRICULTURAL PROJECT IS IN REMOTE AREA
OF GUYANA IN NORTHWEST DISTRICT THAT IS ALMOST TOTALLY
UNINHABITED. ACCESS TO AREA IS RESTRICTED TO AIR
SERVICE, ALTHOUGH ACCESS BY KAITUMA RIVER IS POSSIBLE
FROM ATLANTIC OCEAN.

BURKE

3
LIMITED OFFICIAL USE

Assoc. Dir.	
Dep. AD Adm.	
Dep. AD Inv.	
Asst. Dir.:	
Adm. Serv.	<input checked="" type="checkbox"/>
Crim. Inv.	<input checked="" type="checkbox"/>
Ident.	<input checked="" type="checkbox"/>
Int'l.	
Laboratory	
Legal Coun.	
Plan. & Insp.	
Rec. Mgnt.	
Tech. Servs.	
Training	
Public Affs. Off.	
Telephone Rm.	
Director's Sec'y	

19 NOV 78 19 32z

LIMITED OFFICIAL USE COMMUNICATION SECTION FBB060

PAGE 01 GEORGE 03784 191919Z
ACTION ARA-15

ALL INFORMATION CONTAINED
HEREIN IS UNCLASSIFIED
DATE 9/17/92 BY 1048 [signature]

[Handwritten signature]

INFO OCT-01 ISO-00 SSO-00 CCO-00 OC-06 SS-15 PM-05
NSCE-00 CIAE-00 INR-10 NSAE-00 DODE-00 L-03 H-01
SP-02 INRE-00 AID-05 SY-05 SYE-00 FBIE-00 MCT-02
SVC-00 /070 V

-----093463 191923Z /41

[Handwritten initials]

Z 191930Z NOV 78
RM AMEMBASSY GEORGETOWN
TO SECSTATE WASHDC FLASH 8071

FEDERAL GOVERNMENT

[Handwritten signature: Orymur]

LIMITED OFFICIAL USE GEORGETOWN 3784

[Handwritten: 89-4286-4]

E.O. 11652: NA

TAGS: CASC, OREP, GY

REC

22 NOV 24 1978

SUBJ: OFFER OF ASSISTANCE TO GOVERNMENT OF GUYANA

REF: STATE 293748

[Handwritten signature]

1. UPON RECEIPT REFTEL AMBASSADOR TELEPHONED THE PRIME MINISTER FORBES BURNHAM TO MAKE THE OFFIER OF ASSITANCE REFTEL.

PRIME MINISTER LISTENED CAREFULLY, EXPRESSED APPRECIATION FOR THE OFFER AND SAID HE WOULD BE DISCUSSING IT WITH HIS PEOPLE. HE SAID THAT HE WOULD BE BACK IN TOUCH EITHER LATER

58 NOV 21 1978
58 NOV 21 1978

2. SINCE DICTATING PARA ONE FOREIGN MINISTER RASHLIEGH

JACKSON CALLED ON BEHALF OF PRIME MINISTER TO SAY THAT GDF
WOULD BE GRATEFUL IF TWO 112 HELICOPTERS COULD BE DEPLOYED

IN THE COUNTRY. HE ALSO REQUESTED ON BEHALF OF THE

GUYANA POLICE SLEEPING BAGS AND BLANKETS AS WELL AS
COMMUNICATIONS EQUIPMENT.

3. EMBASSY OFFICER IS IN DIRECT CONTACT WITH POLICE AND

GDF IN AN EFFORT TO SPECIFY THEIR NEEDS.

BURKE

LIMITED OFFICIAL USE

2

UNCLASSIFIED

FBB 058
19 NOV 78 19 13z

Assoc. Dir.	
Dep. AD Adm.	
Dep. AD Inv.	
Asst. Dir.:	
Adm. Serv.	
Ident.	
Intell.	
Laboratory	
Legal Coun.	
Plan. & Insp.	
Rec. Mgmt.	
Tech. Servs.	
Training	
Public Affs. Off.	
Telephone Rm.	
Director's Sec'y	

PAGE 01 GEORGE 03783 191850Z
ACTION ARA-15

FEDERAL BUREAU
OF INVESTIGATION
COMMUNICATIONS SECTION

INFO OCT-01 ISO-00 FBIE-00 CIAE-00 INR-10 NSAE-00
 INRE-00 DODE-00 PA-02 TRSE-00 SCS-06 MCT-02 CA-01
 SY-05 SYE-00 USSS-00 H-02 AID-05 SS-15 SSO-00
 NSCE-00 CCO-00 ICAC-00 SVC-00 OC-06 PM-05 /075 W

for

0 191700Z NOV 78

FM AMEMBASSY GEORGETOWN
TO SECSTATE WASHDC NIACT IMMEDIATE 8070

ALL INFORMATION CONTAINED
HEREIN IS UNCLASSIFIED
DATE 9/19/92 BY 1048PKM/udm

(Handwritten initials)

FEDERAL GOVERNMENT

UNCLAS GEORGETOWN 3783

Rymur

E.O. 11652: NA

TAGS: AFSP, GY

SUBJ: SPECIAL MILITARY AIRCRAFT

89-4286-5

REC-129

22 NOV 24 1978

REF: STATE 293763

1. AMBASSADOR HAS OBTAINED FROM FOREIGN MINISTER RASHLEIGH JACKSON
 CLEARANCE FOR THE ARRIVAL OF SPECIAL MILITARY AIRCRAFT REPORTED IN
 REFTEL. CLEARANCE WAS PROVIDED BY THE FORMIN ON THE UNDERSTANDING
 THAT THE AIRCRAFT WOULD DEPLANE ITS PASSENGERS AND LEAVE IMMEDIATELY.
 PERMISSION TO REFUEL IF NECESSARY WAS, HOWEVER, GRANTED.

2. EMBASSY IS MAKING ARRANGEMENTS TO MEET, PROVIDE TRANSPORTATION
 TO GEORGETOWN AND ARRANGE LODGING FOR PERSONNEL ARRIVING ON
 SPECIAL C-130 FLIGHT.

BURKE

211
58 NOV 28 1978

LIMITED OFFICIAL USE

FBB068

PAGE 01

GEORGE 03789 192104Z

ACTION ARA-15

19 NOV 78 21 35z

Assoc. Dir.	
Dep. AD Adm.	
Dep. AD Inv.	
Asst. Dir.:	
Adm. Serv.	
Crim. Inv.	
Ident.	
Intell.	
Laboratory	
Legal Coun.	
Plan. & Insp.	
Rec. Mgmt.	
Tech. Servs.	
Training	
Public Affs. Off.	
Telephone Rm.	
Director's Sec'y	

INFO OCT-01 ISO-00 H-01 SS-15 ~~SCS-00~~ SSO-00 CIAE-00
 INR-10 NSAE-00 DODE-00 ~~PA-01~~ TRSE-00
 SCS-06 CA-01 MCI-02 IRE-00 SY-05 USSS-00 ~~AI-05~~
 SYE-00 CCO-00 SVC-00 /002 W

ALL INFORMATION CONTAINED
 HEREIN IS UNCLASSIFIED
 DATE 9/17/92 BY 1048 [signature]

-----093639 192109Z /64

O 192110Z NOV 78

FEDERAL GOVERNMENT

FM AMEMBASSY GEORGETOWN

TO SECSTATE WASHDC NIACT IMMEDIATE-8076

ORy mur

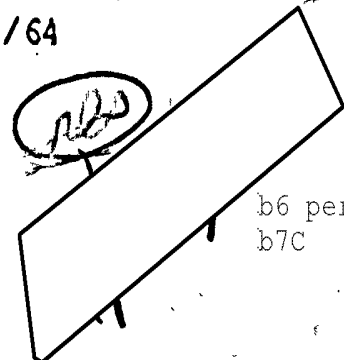

b6 per FBI
b7C

LIMITED OFFICIAL USE GEORGETOWN 3789

89-4286-6

E.O. 11652: NA

REC-129

22 NOV 24 1978

TAGS: CDES GY (AMOS, LINDA SHARON), (HARRIS, LIANE)
 SUBJ: MURDER/SUICIDE AT PEOPLES TEMPLE GEORGETOWN RESIDENCE.

REF: GEORGETOWN 3776

1. THE GUYANA POLICE HAVE REPORTED TO THE EMBASSY THAT A MEMBER OF THE
 PEOPLES TEMPLE RESIDING AT THEIR GEORGETOWN OFFICE RESIDENCE KILLED
 HER THREE CHILDREN AND THEN COMMITTED SUICIDE DURING THE EARLY
 EVENING HOURS OF NOVEMBER 18. (REFTEL)

58 NOV 28 1978

2. THE WOMAN, SHARON AMOS, HAD THREE CHILDREN. THE ELDEST, LIANE HARRIS, WAS ABOUT TWENTY YEARS OLD. THE OTHER TWO, ESTIMATED TO BE AROUND 7 AND 5 YEARS OLD, WERE FROM A SECOND MARRIAGE AND THEIR NAMES ARE AS YET UNKNOWN. SHERWIN HARRIS, LIANE'S FATHER, IS IN GEORGETOWN, HAVING TRAVELED WITH THE GROUP OF CONCERNED RELATIVES THAT ARRIVED WITH CODEL RYAN.

2. SHARON AMOS WAS ONE OF THE LEADERS OF THE PEOPLE'S TEMPLE GROUP AND WAS ACTIVE IN THE GEORGETOWN OPERATION. THE POLICE HAVE INDICATED THAT THE BODIES OF ALL FOUR DECEASED WILL BE HELD FOR A FEW DAYS PENDING INVESTIGATION.

LIMITED OFFICIAL USE

LIMITED OFFICIAL USE

PAGE 02

GEORGE 03789 192104Z

BURKE

2

Assoc. Dir.	
Dep. AD Adm.	
Dep. AD Inv.	
Asst. Dir.:	
Adm.	
Ext. Aff.	
Ident.	
Intell.	
Laboratory	
Legal Coun.	
Plan. & Insp.	
Rec. Mgmt.	
Tech. Servs.	
Training	
Public Aff. Off.	
Telephone Rm.	
Director's Sec'y	

PAGE 01

GEORGE 03787 192033Z

ACTION ARA-15

19 Nov 78 20 44z

INFO OCT-01 ISO-00 FBIE-00 CIAE-00 ^{RECEIVED HEAD OF CIVIL COMMUNICATIONS SECTION} INR-10 NSAE-00
 INRE-00 DODE-00 PA-01 TRSE-00 SCS-06 MCT-02 CA-01
 SY-05 SYE-00 USSS-00 H-01 AID-05 SS-15 SSO-00
 NSCE-00 CCO-00 ICAE-00 SVC-00 062 W

93605 192035Z 150
 ALL INFORMATION CONTAINED
 HEREIN IS UNCLASSIFIED
 DATE 9/17/92 BY 1047 DKM/jsh

0 192035 NOV 78

AMEMBASSY GEORGETOWN

TO SECSTATE WASHDC NIACT IMMEDIATE 8074

FEDERAL GOVERNMENT

Rymur

LIMITED OFFICIAL USE GEORGETOWN 3787

REC-129

E.O. 11652: NA

TAGS: CASC, OREP (RYAN, LEO) GY (LAYTON, LARRY)

DE-15 89-4286-7

SUBJ: CODEL RYAN: SHOOTING INCIDENT

22 NOV 24 1978

REF: GEORGETOWN 3776.

GUYANA

US

1. THE GUYANA POLICE HAVE INFORMED THE EMBASSY OF THE ARREST OF AN AMERICAN CITIZEN IN CONNECTION WITH THE SHOOTING INCIDENT AT

PORT KAITUMA AIRSTRIP NOV. 18. THIS DETAINEE HAS BEEN IDENTIFIED AS LARRY LAYTON, THE BROTHER OF DEBORAH LAYTON BLAKEE AND THE SON OF LISA LAYTO, BOTH OF WHOM HAVE BEEN THE SUBJECTS OF WELFARE

INQUIRIES OTHER CONSULAR TRAFFIC IN THE PAST.

BURKE

58 NOV 21 1978

PAGE 01
ACTION ARA-15

GEORGE 03782 191719Z

Assoc. Dir.	
Dep. AD Adm.	
Dep. AD Inv.	
Asst. Dir.:	
Adm. Serv.	
Crim. Inv.	
Ident.	
Int'l	
Lab.	
Legal Coun.	
Plan. & Insp.	
Rec. Mgmt.	
Tech. Servs.	
Training	
Public Affs. Off.	
Telephone Rm.	
Director's Sec'y	

19 NOV 78 17 34Z
 INFO OCT-01 ISO-00 SSO-00 CCO-00 FBIE-00 CIAE-00
 INR-10 NSAE-00 INRE-00 DODE-00 ONPA-01 ICAE-00
 TRSE-00 SCS-06 MCT-02 CA-01 SY-05 SYE-00 USSS-00
 H-01 AID-05 SS-15 NSCE-00 SVC-00 /002 W

-----093246 191722Z /41

Z 191720Z NOV 78

FM AMEMBASSY GEORGETOWN
TO SECSTATE WASHDC FLASH 8069

FEDERAL GOVERNMENT

ALL INFORMATION CONTAINED
HEREIN IS UNCLASSIFIED
DATE 9/17/92 BY 1049 DKM/jwh

LIMITED OFFICIAL USE GEORGETOWN 3782

Rymur

E.O. 11652: NA
TAGS: CASC, OREP(RYAN, LEO) GY

SUBJ: CODEL RYAN: SECURITY OF "CONCERNED RELATIVES" AT
PEGASUS HOTEL.

REF: GEORGETOWN 3780.

REC-129

89-4286-8

1. SINCE REFTEL CONSUL HAS VISITED THE GROUP OF "CONCERNED RELATIVES" AT THE PEGASUS HOTEL. 22 NOV 24 1978

2. CONSUL REPORTED TO THEM THE SECURITY ARRANGEMENTS THAT WERE IN EFFECT AND RELAYED ASSISTANT COMMISSIONER OF POLICE ROBERTS' FEELING (REPORTED REFTEL. HE ALSO OFFERED THEM IMMEDIATE PASSAGE OUT OF THE COUNTRY ON TODAY'S PANAM FLIGHT WHICH THEY DECLINED. HE THEN OFFERED THEM ALTERNATIVE PASSAGE ON LATER FLIGHTS BUT ALL MEMBERS OF THE GROUP INDICATED THAT THEY WANTED TO REMAIN HERE TO AWAIT FURTHER

DEVELOPMENT 8
21
8 NOV 28 1978

3. CONSUL'S APPEARANCE OBVIOUSLY RELIEVED MUCH OF THE
TENSION AND, WHILE THEY ARE STILL CONCERNED FOR THEIR OWN
SAFETY, EACH HAS ELECTED TO REMAIN AT PEGASUS WHERE AT LEAST
SIX ARMED POLICEMEN ARE PROTECTING THEM.

LIMITED OFFICIAL USE

LIMITED OFFICIAL USE

PAGE 02

GEORGE 03782 191719Z

BURKE

2

Assoc. Dir.	
Dep. AD Adm.	
Dep. AD Inv.	
Asst. Dir.:	
Adm. Serv.	
Ident.	
Intell.	
Laboratory	
Legal Coun.	
Plan. & Insp.	
Rec. Mgmt.	
Tech. Serv.	
Training	
Public Aff. Off.	
Telephone Rm.	
Director's Sec'y	

PAGE 01 GEORGE 03781 191534Z
ACTION ARA-15

19 Nov 78 15 46z

INFO OCT-01 ISO-00 FBIE-00 CIAE-00 INR-10 NSAE-00
 INRE-00 DODE-00 PA-01 TRSE-00 ATISCS-06 MCT-02 CA-01
 COMMUNICATIONS SECTION
 SY-05 SYE-00 USSS-00 H-01 AID-05 SS-15 SSO-00
 NSCE-00 CCO-00 ICAE-00 SVC-00 /062 W

-----093056 191536Z /50

Z 191535Z NOV 78

FM AMEMBASSY GEORGETOWN
TO SECSTATE WASHDC FLASH 8068

ALL INFORMATION CONTAINED
HEREIN IS UNCLASSIFIED
DATE 9/17/92 BY 1049 DCM/ldj

FEDERAL GOVERNMENT

Ryanur

LIMITED OFFICIAL USE GEORGETOWN 3781

E.O. 11652: NA

TAGS: CASC, OREP (RYAN, LEO) GY

SUBJ: CODEL RYAN: FIRST WOUNDED ARRIVE AT TIMEHRI INTERNATIONAL
AIRPORT, GEORGETOWN

REF: GEORGETOWN 3774.

REC-129

89 - 4286 - 9

22 NOV 24 1978

1. EMBASSY HAS JUST BEEN INFORMED THE GOF ISLANDER
CARRYING FIVE WOUNDED FROM PORT KAITUMA HAS JUST ARRIVED

AT THE TIMEHRI AIRPORT. FIVE WOUNDED HAVE BEEN TRANSFERRED
TO THE C-141A. LIST OF INDIVIDUALS AND GENERAL CONDITION

IS AS FOLLOWS: JACKIE SPEIER (LEGISLATIVE COUNSEL TO

CONGRESSMAN RYAN), SERIOUS; SONG (NBC TV), SERIOUS;
ANTHONY KATSARIS (CONCERNED RELATIVE), NOT AS SERIOUS

58 NOV 28 1978
FINALLY REPORTED FROM PORT KAITUMA; MRS. BEVERLY
OLIVER (CONCERNED RELATIVE), NOT SERIOUS; MRS. CATHY
BOYD (CONCERNED RELATIVE, NOT SERIOUS.

ms

2. SECOND AIRCRAFT FROM PORT KAITUMA WITH THE REMAINING
EVACUEES IS DUE WITHIN THE NEXT HOUR.

BURKE

LIMITED OFFICIAL USE

2

Assoc. Dir.	_____
Dep. AD Adm.	_____
Dep. AD Inv.	_____
Asst. Dir.:	_____
Adm. Serv.	_____
Crim. Inv.	_____
Ident.	_____
Intell.	<u>WOC/KS</u>
Laboratory	_____
Legal Coun.	_____
Plan. & Insp.	_____
Rec. Mgnt.	_____
Tech. Servs.	_____
Training	_____
Public Affs. Off.	_____
Telephone Rm.	_____
Director's Sec'y	_____

LIMITED OFFICIAL USE

FBB026

19 NOV 78 00 03Z

PAGE 01
ACTION ARA-15

GEORGE 03776
COMMUNICATIONS SECTION

INFO OCT-01 ISO-00 H-01 SS-15 NSCE-00 SSO-00 CIAE-00
DODE-00 PA-01 JUSE-00 TRSE-00 SCS-06 CA-01 MCT-02
INR-10 INRE-00 SY-05 USSS-00 AID-05 SYE-00 CCO-00
(AS-01, FBIE-00,) W

Z 190315Z NOV 78
FM AMEMBASSY GEORGETOWN

22 APR 85 FORM 128346ZNY/ASACD
HEREIN IS UNCLASSIFIED
DATE 9/17/92 BY 1048 DUB/rdm

b6 per FE
b7C

TO SECSTATE WASHDC FLASH 8063

FEDERAL GOVERNMENT

RYMUR

LIMITED OFFICIAL USE GEORGETOWN 3776

AMBASSADOR SENDS

E.O. 11652: NA
TAGS: CASC, OREP (RYAN LEO) GY
SUBJ: CODEL RYAN: SHOOTING INCIDENT AT PORT KAITUMA.

REC-129 89-4286-6

10EM 3062

b6 per FE
b7C

22 NOV 24 1978

REF: GEORGETOWN 3774.

1. I HAVE JUST RETURNED FROM A MEETING WITH PRIMIN BURNHAM,
DEPUTY PRIMIN REID, FORMIN JACKSON, AND MINISTER OF
INFORMATION SHIRLEY FIELD-RIDLEY. VARIOUS OFFICERS OF
THE GUYANA DEFENSE FORCE WERE ALSO IN ATTENDANCE. CREWS
OF THE TWO CHARTER AIRCRAFT WHICH HAD BEEN SHOT AT DURING

58 NOV 26 1978

[Handwritten signature]

THE INCIDENT AT PORT KAITUMA HAD JUST ARRIVED AND WERE ALSO PRESENT. FOLLOWING RECONSTRUCTION OF INCIDENT IS BASED ON THEIR TESTIMONY WHICH MUST BE USED CAREFULLY IN VIEW OF THEIR UNDERSTANDABLY EMOTIONAL STATE.

2. BOTH CHARTER AIRCRAFT HAD ARRIVED AT PORT KAITUMA AND HAD COMMENCED LOADING CONGRESSMAN RYAN'S PARTY. THE SMALLER OF THE TWO, A FIVE-PASSENGER CESSNA, HAD ALREADY LOADED APPARENTLY, WITH AT LEAST TWO OR THREE OF THE JONESTOWN RESIDENTS WHO HAD ELECTED TO LEAVE THE COMMUNITY WITH

LIMITED OFFICIAL USE

LIMITED OFFICIAL USE

PAGE 02 GEORGE 03776 190326Z

CONGRESSMAN RYAN, AMONG ITS FIVE PASSENGERS. ACCORDING TO THE PILOT ONE OF THE

INDIVIDUALS PRODUCED A PISTON AND BEGAN FIRING WITHIN THE AIRCRAFT AT THE OTHER PASSENGERS. AT ALMOST THE

SAME TIME A TRACTOR PULLING A CART APPEARED ON THE

SCENE. THE CART WAS LOADED WITH SEVERAL PEOPLE AND WHEN IT APPROACHED THE AIRCRAFT THE INDIVIDUALS IN THE CART BEGAN FIRING AT THE CLUSTER OF PEOPLE WHO

HAD NOT YET BOARDED THE SECOND LARGER AIRCRAFT. SEVERAL OF THE PEOPLE, ACCORDING TO THE PILOTS, WERE

2

IMMEDIATELY STRUCK BY BULLETS AND IN THEIR ESTIMATION WERE KILLED DURING THE FIRST FUSILLADE. THIS GROUP INCLUDED CONGRESSMAN RYAN AND MEMBERS OF THE NBC CAMERA TEAM. THE FIRING ALSO DAMAGED THE ENGINES OF THE SECOND AIRCRAFT AND RENDERED IT UNFLYABLE. PEOPLE STILL ON THE GROUND WHO WERE NOT WOUNDED OR WERE WOUNDED AND AMBULATORY RAN INTO THE BUSHES SURROUNDING THE AIRSTRIP TO ESCAPE THE FIRE. THE THREE-MAN CREW IN THE DISABLED AIRCRAFT SCRAMBLED ABOARD THE CESSNA WHICH WAS TAXIING DOWN THE RUNWAY. THIS AIRCRAFT MANAGED TO TAKE OFF WITH BOTH CREWS PLUS ONE WOUNDED PASSENGER WHO APPARENTLY WAS ONE OF THE PERSONS WHO HAD ELECTED TO LEAVE GEORGETOWN. (SHE IS NOW IN A HOSPITAL IN GEORGETOWN.)

3. NEITHER CREW HAD ANY GREAT FAMILIARITY WITH THE INDIVIDUAL PASSENGERS WITH THE EXCEPTION OF THE CONGRESSMAN, THE NBC CAMERA TEAM AND THE DCM AND THUS COULD NOT READILY IDENTIFY CASUALTIES. THEY DID REPORT, HOWEVER, THAT WHEN THEY LEFT PORT KAITUMA THE DCM SEEMED TO BE AMBULATORY BUT PERHAPS SLIGHTLY WOUNDED. THE CONGRESSMAN AND THE CAMERA TEAM APPEARED TO BE DEAD.

LIMITED OFFICIAL USE

LIMITED OFFICIAL USE

3

4. AFTER THE MEETING WITH THE PRIME MINISTER THE AIR CREWS WERE TAKEN IN CHARGE BY THE COMMISSIONER OF POLICE FOR A MORE INTENSIVE DEFRIEFING. I HAVE SENT AN EMBASSY POLITICAL OFFICER TO BE PRESENT AT THIS SESSION.

5. UNITS OF THE GUYANA DEFENSE FORCE AND THE POLICE ARE BEING AIRLIFTED DURING NIGHT HOURS TO MATTHEWS RIDGE, THE CLOSEST AIRSTRIP CAPABLE OF TAKING AIRCRAFT AFTER DARK. GDF IS ALSO POSITIONING TOW HELICOPTERS AT MATTHEWS RIDGE IN ORDER TO BE ABLE TO SHUTTLE TROOPS INTO PORT KAITUMA AT FIRST LIGHT. THERE IS ALREADY A SMALL GDF UNIT AT PORT KAITUMA NUMBERING PERHAPS NO MORE THAN SIX. AS OF NOW THERE IS NO COMMUNICATION LINK WITH PORT KAITUMA.

6. THE PRIME MINISTER EXPRESSED HIS DEEP REGRET OVER THIS TRAGIC INCIDENT AND WISHED THIS TO BE CONVEYED URGENTLY TO USG. HE NOTED THAT HIS GOVERNMENT HAD BEEN MOST FACILITATIVE REGARDING THE CODEL'S VISIT.

7. I TOLD THE PRIME MINISTER THAT OUR IMMEDIATE CONCERNS WERE AS FOLLOWS: (1) THAT THE GDF MAKE EVERY EFFORT TO GET INTO PORT KAITUMA TO FURNISH AID, ASSISTANCE AND PROTECTION TO THE AMERICANS WHO WERE STILL THERE, (2) THAT AS SOON AS POSSIBLE THE BODIES OF THE DEAD SHOULD BE BROUGHT TO GEORGETOWN, AND (3) THAT THE PERPETRATORS OF THIS OUTRAGE BE BROUGHT TO JUSTICE AS SOON AS POSSIBLE.

8. I LEFT THE PRIME MINISTER'S OFFICE AT THIS POINT AND RETURNED TO THE EMBASSY.

9. WE HAVE ALSO LEARNED THAT THERE HAVE BEEN THREE MURDERS AND ONE SUICIDE AT THE PEOPLE'S TEMPLE OFFICE IN GEORGETOWN. BURKE

4

Assoc. Dir.	
Dep. AD Adm.	
Dep. AD Inv.	
Asst. Dir.:	
Adm. Serv.	
Crim. Inv.	
Ident.	
Insp.	
Laboratory	
Legal Coun.	
Plan. & Insp.	
Rec. Mgmt.	
Tech. Servs.	
Training	
Public Affs. Off.	
Telephone Rm.	
Director's Sec'y	

PAGE 01
ACTION ARA-15

GEORGE 03780 191509Z

19 Nov 78 1518z

INFO OCT-01 ISO-00 FBIE-00 CIAE-00 INR-10 NSAE-00
 INRE-00 DODE-00 PA-01 TRSE-00 SCS-06 MCT-02 CA-01
 SY-05 SYE-00 USSS-00 H-01 AID-05 SS-15 SSO-00
 NSCE-00 CCO-00 SVC-00 /062 W

-----093004 191512Z /50

Z 151510Z NOV 78

FM AMEMBASSY GEORGETOWN
TO SECSTATE WASHDC FLASH 8067

FEDERAL GOVERNMENT

ALL INFORMATION CONTAINED
HEREIN IS UNCLASSIFIED

DATE 9/17/92 BY 1648 DVM/vdm

LIMITED OFFICIAL USE GEORGETOWN 3780

Wes
Rymur

E.O. 11652: NA

TAGS: CASC, OREP (RYAN, LEO) GY

SUBJ: CODEL RYAN: SECURITY OF "CONCERNED RELATIVES" AT PEGASUS
HOTEL

REC-129

89-4286-11

REF: AMB/ASST SEC VAKY TELECON NOV. 19

22 NOV 24 1978

1. SINCE REFTELCON CONSUL HAS BEEN IN TOUCH WITH
 ASST. CRIME CHIEF ROBERTS WHO IS DIRECTLY IN CHARGE OF
 SECURITY OF THE "CONCERNED RELATIVES" AT THE PEGASUS HOTEL.
 THE PROPOSITION WAS PUT TO ROBERTS AS TO WHETHER OR NOT
 IT MIGHT BE ADVANTAGEOUS TO MOVE THE GROUP, REPRESENTED BY
 TIM STOEN, TO THE CONSULATE BUILDING. ROBERTS COUNSELED
 AGAINST THIS MOVE SAYING THAT HE HAD ASSIGED AS MUCH
 SECURITY AS POSSIBLE TO THE PEGASUS SPECIFICALLY FOR THE
 PROTECTION OF THESE PEOPLE.

58 NOV 28 1978

2. WE WILL BE IN CONTINUING TOUCH WITH STOEN AND THE

OTHERS IN AN EFFORT ASSURAGE THEIR CONCERNS.

BURKE

LIMITED OFFICIAL USE

2

Assoc. Dir.	
Dep. AD Adm.	
Dep. AD Inv.	
Asst. Dir.:	
Adm. Serv.	
Crim. Inv.	
Ident.	
Intell.	
Laboratory	
Legal Coun.	
Plan. & Insp.	
Rec. Mgmt.	
Tech. Servs.	
Training	
Public Aff. Off.	
Telephone Rm.	
Director's Sec'y	

PAGE 01 GEORGE 03779 191446Z
ACTION ARA-1"

INFO OCT-01 ISO-00 FBIE-00 ^{9 Nov 78} ~~OTAE-00~~ ^{15 00Z} ~~DOBE-00~~ PA-01
 TRSE-00 SCS-06 MCT-02 CA-01 ~~INR-10~~ INRE-00 SY-05
 SYE-00 USSS-00 H-01 ~~AID-05~~ ~~SS-15~~ ~~STION~~ SSO-00 NSCE-00
 CCO-00 SVC-00 /062 W

-----092921 191449Z /41

Z 191450Z NOV 78
 FM AMEMBASSY GEORGETOWN
 TO SECSTATE WASHDC FLASH 8066

ALL INFORMATION CONTAINED
 HEREIN IS UNCLASSIFIED
 DATE 9/17/92 BY SP8DCK/eds

FEDERAL GOVERNMENT

Rymur

WDS

LIMITED OFFICIAL USE GEORGETOWN 3779

E. O. 11652: NA
 TAGS: CASC OREP (RYAN, LEO) GY
 SUBJ: CODEL RYAN: SITUATION REPORT AS OF 1100 LOCAL (0900 EST).
 REF: GEORGETOWN 3774.

REC-129 *89-4286-12*

22 NOV 24 1978

1. COMMISSIONER OF POLICE NOW REPORTS THAT ONE MORE DEATH HAS BEEN CONFIRMED AT PORT KAITUMA. THE NAME OF THE INDIVIDUAL IS PATRICIA PARKS WHO DOES NOT FIGURE ON ANY OF OUR LISTS. MUST THEREFORE ASSUME THAT SHE MAY HAVE BEEN ONE OF THE JONESTOWN RESIDENTS WHO HAD ELECTED TO LEAVE WITH CONGRESSMAN RYAN.

2. THE PREVIOUSLY UNIDENTIFIED PHOTOGRAPHER HAS NOW BEEN IDENTIFIED AS GREGORY ROBINSON OF THE SAN FRANCISCO EXAMINER. AGAIN, THE SOURCE OF THIS INFORMATION IS THE COMMISSIONER OF POLICE.

508 NOV 28 1978

3. AS YET NO GDF OR POLICE UNITS HAVE BEEN REPORTED AS HAVING ENTERED JONESTOWN ITSELF. WE EXPECT THIS WILL OCCUR WITHIN THE NEXT FEW HOURS.

4. MEDIVAC C-141 ARRIVED AT TIMEHRI AIRPORT ON SCHEDULE
LIMITED OFFICIAL USE

LIMITED OFFICIAL USE

PAGE 02

GEORGE 03779 191446Z

AT 1005 LOCAL (0800 EST). PLANE CAPTAIN AND CHIEF MEDICAL OFFICER ARE IN TOUCH WITH EMBASSY REPRESENTATIVES WHO IN TURN ARE PUTTING THEM IN CONTACT WITH LOCAL HEALTH OFFICIALS. EMBASSY HAS RECEIVED WORD THAT TWO AND PERHAPS THREE PRESS CHARTERS ARE ENROUTE GEORGETOWN. WOULD APPRECIATE ANY INFORMATION DEPARTMENT MAY BE ABLE TO GIVE US AS TO NAMES AND AFFILIATIONS OF PASSENGERS.

BURKE

J

Assoc. Dir.	_____
Dep. AD Adm.	_____
Dep. AD Inv.	_____
Asst. Dir.:	_____
Adm. Serv.	<u> </u>
Crim. Inv.	<u> </u>
Ident.	<u> </u>
Int'l.	_____
Laboratory	_____
Legal Coun.	_____
Plan. & Insp.	_____
Rec. Mgnt.	_____
Tech. Servs.	_____
Training	_____
Public Affs. Off.	_____
Telephone Rm.	_____
Director's Sec'y	_____

PAGE 01
ACTION ARA-15

GEORGE 03778 191057Z

19 NOV 78 11 24z

INFO OCT-01 ISO-00 H-01 SS-15 ~~FFD~~ SY-05 INR-10 CA-01
MCT-02 SCS-06 PA-01 AID-05 ~~COMMUNICATIONS SECTION~~ CCO-00 SSO-00
NSCE-00 USSS-00 INRE-00 TRSE-00 DODE-00 CIAE-00
FBIE-00 SVC-00 /062 W

-----092409 191059Z /21

Z 191105Z NOV 78
FM AMEMBASSY GEORGETOWN
TO SECSTATE WASHDC FLASH 8065

Rymur

res

FEDERAL GOVERNMENT

ALL INFORMATION CONTAINED
HEREIN IS UNCLASSIFIED
DATE 9/17/92 BY 105 DCM/ndr

LIMITED OFFICIAL USE GEORGETOWN 3778

SEC. 130

89-4286-13

E.O. 11652: NA

TAGS: CASC, OREP (RYAN, LEO) GY

SUBJ: CODEL RYAN: FIRST REPORTS FROM PORT KAITUMA

22 NOV 24 1978

REF: 3774

[Handwritten signature]

1. POLICE COMMISSIONER LLOYD BARKER ON INSTRUCTIONS FROM
THE PRIME MINISTER CALLED AMBASSADOR 0715 LOCAL TIME
(0520 EST) TO INFORM HIM THAT POLICE UNITS HAD GOTTEN TO
THE AIRSTRIP AT PORT KITUMA.

58 NOV 28 1978

2. ACCORDING TO COMMISSIONER GOG POLICE ON THE SCENE
CONFIRMED THE DEATHS OF CONGRESSMAN LEO RYAN; MR. ROBERT
BROWN, NBC; MR. DON HARRIS, NBC; PLUS ONE AS YET
UNIDENTIFIED PHOTOGRAPHER. THERE ARE ALSO SIX WOUNDED AT
THE AIRSTRIP INCLUDING DCM DWYER; SONG, NBC; MISS JACKIE
SPEIER (LEGAL COUNSEL TO CODEL); PLUS TWO OTHERS AS YET
UNIDENTIFIED.

3. COMMISSIONER BARKER WAS INFORMED THAT MEDIVAC C-141
IS DUE AT TIMEHRI AIRPORT 1000 HOURS LOCAL (0800 EST).
HE WAS URGED TO PROVIDE INFORMATION AS SOON AS
POSSIBLE WHEN WOUNDED COULD BE EVACUATED FROM

LIMITED OFFICIAL USE

LIMITED OFFICIAL USE

PAGE 02

GEORGE 03778 191057Z

PORT KAITUMA TO TIMEHRI AIRPORT, GEORGETOWN.

BURKE

2

UNCLASSIFIED

19 Nov 78 BBA 597 262

Assoc. Dir.	_____
Dep. AD Adm.	_____
Dep. AD Inv.	_____
Asst. Dir.:	_____
Adm. Serv.	_____
Crim. Inv.	_____
Ident.	_____
Intell.	_____
Laboratory	_____
Legal Coun.	_____
Plan. & Insp.	_____
Rec. Mgmt.	_____
Tech. Servs.	_____
Training	_____
Public Affs. Off.	_____
Telephone Rm.	_____
Director's Sec'y	_____

FEDERAL BUREAU OF INVESTIGATION COMMUNICATIONS SECTION

PAGE 01 STATE 293763 ORIGIN ARA-15

INFO OCT-01 ISO-00 FBIE-00 CIAE-00 INR-10 NSAE-00
 INRE-00 DODE-00 PA-02 TRSE-00 SCS-06 MCT-02 CA-01
 SY-05 SYE-00 USSS-00 H-02 AID-05 SS-15 SSO-00
 NSCE-00 CCO-00 ICAE-00 SVC-00 OC-06 /070 R

FEDERAL GOVERNMENT DRAFTED BY ARA/EX:WDCALDERHEAD:JE

APPROVED BY ARA/EX:WDCALDERHEAD ARA:JABUSHNELL

S/S-O:JTHYDEN

OR Y M U R E

(WDC)

O 191759Z NOV 78 ZFFA

FM SECSTATE WASHDC

TO AMEMBASSY GEORGETOWN NIACT IMMEDIATE
REC-130

UNCLAS STATE 293763

ALL INFORMATION CONTAINED
HEREIN IS UNCLASSIFIED
DATE 9/17/92 BY 1048 DCM/ndm

89 - 4286 - 14

22 NOV 24 1978

E.O. 11652: N/A

TAGS: AFSP, GY

SUBJECT: SPECIAL MILITARY AIRCRAFT

1. SPECIAL MILITARY AIRCRAFT WILL DEPART PANAMA 1330 HOURS
WASHINGTON TIME TODAY ENROUTE TO GEORGETOWN WITH EMERGENCY

SUPPORT TEAM
58 NOV 28 1978

2. ON BOARD WILL BE DCM/PANAMA VICTOR DIKEOS, CONSULAR OFFICER CHARLES ENGLISH, ADMINISTRATIVE/SY OFFICER RICHARD MAY, AND COMMUNICATOR ANTHONY MONTANA.

3. AIRCRAFT WILL STOP AT CARACAS IN MID-AFTERNOON AND PICK UP CONSULAR OFFICER RICHARD MARTIN, ADMINISTRATIVE OFFICER DOUGLAS DAVIDSON AND COMMUNICATOR ROBERT HALL.

4. WE HOPE HAVE ON BOARD AS WELL A FOUR-MAN MILITARY

UNCLASSIFIED

UNCLASSIFIED

PAGE 02

STATE 293763

COMMUNICATIONS TEAM WHICH WILL HAVE ITS OWN INDEPENDENT COMMUNICATIONS GEAR AND CAPABILITY.

5. AIRCRAFT ETA GEORGETOWN APPROXIMATELY 2000 HOURS WASHINGTON TIME THIS EVENING.

6. CONSULAR OFFICER JOHN ADAMS FROM PORT OF SPAIN WILL ALSO JOIN YOU SHORTLY AND IS MAKING HIS ARRANGEMENTS TO ARRIVE BY COMMERCIAL MEANS. VANCE

2

UNCLASSIFIED

FBB069

PAGE 01 STATE 293771

ORIGIN ARA-15

19 Nov 78 21 26z

INFO OCT-01 ISO-00 FBIE-00 CIAE-00 ~~IR-10~~ NSAE-00

INRE-00 DODE-00 PA-02 TRSE-00 SCS-06 MCT-02 CA-01
SY-05 SYE-00 USSS-00 H-02 AID-05 SS-15 SSO-00

NSCE-00 CCO-00 ICAE-00 SVC-00 PM-05 /069 R

FEDERAL GOVERNMENT

ALL INFORMATION CONTAINED
HEREIN IS UNCLASSIFIED
DATE 9/17/92 BY 1048 DUM/ndal

DRAFTED BY ARA/EX:WDCALDERHEAD:JE

APPROVED BY ARA/EX:WDCALDERHEAD

ARA:JABUSHNELL
S/S-0:JTHYDEN

Rymur

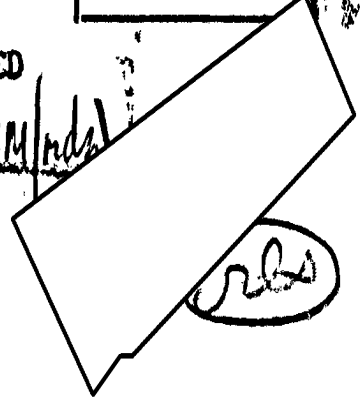

b6 per FBI
b7C

-----093649 192112Z /64

O 192046Z NOV 78 ZFFA
FM SECSTATE WASHDC

TO AMEMBASSY GEORGETOWN NIACT IMMEDIATE

REC-130

89-4286-15

22 NOV 24 1978

UNCLAS STATE 293771

E.O. 11652: N/A

58 NOV 28 1978
TAGS: AFSP, GY

Assoc. Dir.	
Dep. AD Adm.	
Dep. AD Inv.	
Asst. Dir.:	
Adm. Serv.	
Crim. Inv.	
Ident.	
Insp.	
Intell.	
Lab.	
Legal Coun.	
Plan. & Insp.	
Rec. Mgmt.	
Tech. Serv.	
Training	
Publ. Affs. Off.	
Telephone Rm.	
Director's Sec'y	

SUBJECT: SPECIAL MILITARY AIRCRAFT

1. TO FACILITATE ARRANGING EMERGENCY CLEARANCE FOR C-130 AIRCRAFT WHICH DEPARTS PANAMA AT 1330 HOURS AND SCHEDULED ARRIVE GEORGETOWN APPROXIMATELY 2000 HOURS, THE FOLLOWING INFORMATION ON AIR CREW IS PROVIDED.

2. AIRCRAFT COMMANDER - RUSSELL C. BURNHAM, SSN [REDACTED]

[REDACTED] CO-PILOT - 2ND LT. WILLIAM S. LAGLE, SSN [REDACTED]

NAVIGATOR - MAJOR CHARLES J. HOLLER, SSN [REDACTED]

FLIGHT ENGINEER - M/SGT. LAWRENCE G. HALTER, SSN [REDACTED]

b6 Per Dept. of Stat

[REDACTED] LOG MASTER - T/SGT. RONALD L. DOWDEN, SSN [REDACTED]

[REDACTED] CREWMAN T/SGT. D. R. SHEPPARD, SSN [REDACTED]

CREWMAN S/SGT. S. G. SHEPLER, SSN [REDACTED]

COMMUNICA-

TIONS CAPTAIN MICHAEL MASSINGALE, SSN [REDACTED]

UNCLASSIFIED

UNCLASSIFIED

PAGE 02

STATE 293771

COMMUNICATIONS M/SGT. ALVIN HUDDLESTON, SSN [REDACTED]

b6 Per Dept. of State

COMMUNICATIONS T/SGT. W.D. DALTON, SSN [REDACTED]

COMMUNICATIONS SGT. D.P. METTERVILLE, SSN [REDACTED]

FLIGHT SURGEON LT. COL. B. POITRAS, SSN [REDACTED]

3. DEPENDING ON SPACE REQUIRED FOR SPECIAL COMMUNICATIONS GEAR, THE C-130 IS EXPECTED TO HAVE BETWEEN 45 AND 65 SEATS AVAILABLE FOR EVACUATION PURPOSES.

4. THE C-130 AIRCRAFT IS IDENTIFIED AS USAF FLIGHT MAC 60468.

5. DEPARTMENT HAS RECEIVED YOUR 8070 CONCERNING FONMIN JACKSON'S REQUEST THAT AIRCRAFT DEPLANE ITS PASSENGERS AND LEAVE IMMEDIATELY. THIS MESSAGE HAS BEEN PASSED TO THE AIRCRAFT WHICH IS ALREADY ENROUTE. IF IMMEDIATE DEPARTURE INDEED ESSENTIAL, THEN IT WILL BE NECESSARY FOR ANYONE SEEKING EVACUATION VIA MILITARY AIRCRAFT TO BE AT THE AIRPORT READY FOR IMMEDIATE DEPARTURE.

VANCE

~~CONFIDENTIAL~~

FBB070

PAGE 01

STATE 293776

~~CONFIDENTIAL~~

ORIGIN ARA-15

19 NOV 78 21 37Z

INFO OCT-01 EUR-12 ISO-00 CIAE-00 DODE-00 NSAE-00

NSCE-00 SSO-00 ICAE-00 IARE-00 IOFBIE-00 PA-01

IRSE-00 SCS-06 CA-01 MCT-02 SY-05 SYE-00 USSS-00

H-01 AID-05 SS-15 CCO-00 OC-06 PM-05 /075 R

FEDERAL GOVERNMENT

DRAFTED BY ARA

APPROVED BY ARA

S/S-O

b6 per FBI
b7C

FBI
ALL INFORMATION CONTAINED
HEREIN IS UNCLASSIFIED
DATE 9/17/92 BY 1048 DCM/MDM

Rymur

Assoc. Dir.	
Dep. AD Adm.	
Dep. AD Inv.	
Asst. Dir.:	
Adm. Serv.	
Crim. Inv.	
Ident.	
Insp.	
Intell.	
Laboratory	
Legal Coun.	
Plan. & Insp.	
Rec. Mgmt.	
Tech. Serv.	
Training	
Public Affs. Off.	
Telephone Rm.	
Director's Sec'y	

-----093667 192122Z /62

O 192049Z NOV 78

FM SECSTATE WASHDC

TO AMEMBASSY GEORGETOWN IMMEDIATE

AMEMBASSY PANAMA IMMEDIATE

AMEMBASSY CARACAS IMMEDIATE

AMEMBASSY PORT OF SPAIN IMMEDIATE

AMEMBASSY LONDON IMMEDIATE

9/17/92 1048 DCM/MDM

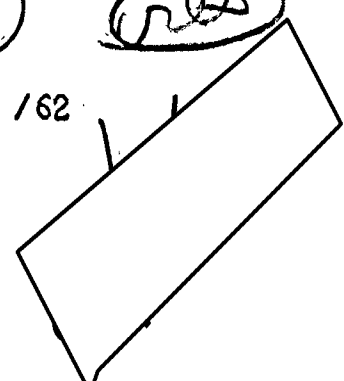

REC-130

89 - 4286 - 16

22 NOV 24 1978

~~CONFIDENTIAL~~ STATE 293776

LONDON FOR MICHAEL FINLEY
Declass per State let 2/16/2005
UC 65179 DMH/ST/bpg

E.O. 11652: GDS

TAGS: CASC, OREP (RYAN, LEO), GY

~~CONFIDENTIAL~~

58 NOV 28 1978

Handwritten signature or initials.

SUBJECT: SITUATION REPORT NO. III

1. SITUATION IN GUYANA AS OF 1300 HOURS (EST), NOVEMBER 19, 1978. IN ADDITION TO THE THREE CONFIRMED DEAD NAMED IN SITREP II, THE GOVERNMENT OF GUYANA HAS PROVIDED US

WITH TWO NAMES FROM THE PARTY ATTACKED AT THE AIRSTRIP

NEAR THE PEOPLES TEMPLE ON NOVEMBER 18: GREGORY ROBINSON, SAN FRANCISCO EXAMINER, AND PATRICIA PARKS, WHOM WE PRESUME

WAS ONE OF THE JONESTOWN RESIDENTS WHO ELECTED TO LEAVE

WITH CONGRESSMAN RYAN. THIS MAKES A TOTAL OF FIVE KNOWN

~~CONFIDENTIAL~~

~~CONFIDENTIAL~~

PAGE 02

STATE 293776

DEAD. ARRANGEMENTS ARE BEING MADE BY THE GUYANESE TO PERFORM AUTOPSIES, REQUIRED UNDER GUYANESE LAW WHEN A CRIME IS INVOLVED, AS SOON AS POSSIBLE. AN AMERICAN MEDICAL PATHOLOGIST, WHO ACCOMPANIED A U.S. C-141 MEDIVAC PLANE TO GEORGETOWN, STAYED BEHIND TO HELP WHEN THE C-141 LEFT EARLIER TODAY WITH THE WOUNDED.

2. THE MEDICAL EVACUATION AIRCRAFT IS AIRBORNE WITH NINE WOUNDED. THE SERIOUSLY WOUNDED ARE: JACKIE SPEIER, LEGISLATIVE COUNSEL TO CONGRESSMAN RYAN AND S. SONG OF NBC T.V. OTHER WOUNDED ARE MRS. BEVERLY OLIVER, A

~~CONFIDENTIAL~~

2

CONCERNED RELATIVE; MRS. CATHY BOYD, A CONCERNED RELATIVE,
AND ANTHONY KATSARIS, A CONCERNED RELATIVE. WE DO NOT
HAVE AS YET THE NAMES OF THE OTHER WOUNDED. RICHARD DWYER,
OUR DEPUTY CHIEF OF MISSION IN GEORGETOWN, WAS ALSO
WOUNDED SLIGHTLY, BUT IS REMAINING AT PORT KAITUMA.
THE WHITE HOUSE IS AUTHORIZING A SECOND MEDIVAC FLIGHT,
SHOULD ONE PROVE NECESSARY.

~~CONFIDENTIAL~~

3. THE NATIONAL MILITARY COMMAND CENTER IS SENDING A
C-130 AIRCRAFT FROM PANAMA TO BRING SIX ADDITIONAL
AMERICAN FOREIGN SERVICE CONSULAR, ADMINISTRATIVE AND
COMMUNICATIONS PERSONNEL, AS WELL AS OUR DCM FROM PANAMA,
FROM OUR EMBASSIES AT PANAMA CITY AND CARACAS. ANOTHER
CONSULAR OFFICER IS FLYING TO GEORGETOWN FROM TRINIDAD.
THE C-130 WILL ALSO BRING A U. S. FOUR-MAN MILITARY
COMMUNICATIONS TEAM TO GUYANA.

4. OUR AMBASSADOR TO GUYANA, JOHN BURKE, HAS TOLD
PRIME MINISTER BURNHAM OF GUYANA THAT THE UNITED STATES
IS PREPARED TO PROVIDE ANY NECESSARY OR USEFUL ASSISTANCE
TO GUYANA TO CONTROL THE SITUATION IN THE PEOPLES

~~CONFIDENTIAL~~

~~CONFIDENTIAL~~

3

CONFIDENTIAL

~~CONFIDENTIAL~~

PAGE 03

STATE 293776

TEMPLE AREA AND PREVENT THE LOSS OF LIFE. PRIME MINISTER BURNHAM EXPRESSED HIS APPRECIATION AND WILL LOOK INTO WHAT ASSISTANCE IS NEEDED OR WILL BE HELPFUL.

5. GUYANESE MILITARY FORCES COMMENCED ABOUT 1300 WASHINGTON TIME TO ADVANCE TOWARD JONESTOWN. THEY ARE PROCEEDING CAUTIOUSLY BECAUSE OF REPORTS OF ARMED PEOPLES TEMPLE MEMBERS IN THE AREA. VANCE

~~CONFIDENTIAL~~

4

Assoc. Dir.	
Dep. AD Adm.	
Dep. AD Inv.	
Asst. Dir.:	
Adm. Serv.	<input checked="" type="checkbox"/>
Crim. Inv.	<input checked="" type="checkbox"/>
Ident.	
Int'l.	
Laboratory	
Legal Coun.	
Plan. & Insp.	
Rec. Mgmt.	
Tech. Servs.	
Training	
Public Affs. Off.	
Telephone Rm.	
Director's Sec'y	

20 Nov 78 18 03z

FEDERAL GOVERNMENT

RECEIVED
FEDERAL BUREAU OF INVESTIGATION
COMMUNICATIONS SECTION
FBI 116

UNCLASSIFIED

PAGE 01 CARACA 10950 201632Z

ACTION SY-05

INFO OCT-01 ARA-15 ISO-00 SYE-00 FBIE-00 / 0211

b6 per FBI
b7c

O R 201605Z NOV 78

-----098813 201759Z / 47

ALL INFORMATION CONTAINED
HEREIN IS UNCLASSIFIED
DATE 9/12/92 BY 1048 OKM/ndm

FM AMEMBASSY CARACAS

Rymur

WDS

TO AMEMBASSY GEORGETOWN IMMEDIATE
INFO SECSTATE WASHDC 4684

UNCLAS CARACAS 10950

FOR RSO FROM RSO

REC-130

89-4286-17

E.O. 11652: N/A

22 NOV 24 1978

TAGS: ASEC

SUBJECT: ASSISTANCE

1. RSO LOPEZ AVAILABLE TO PROVIDE ANY ASSISTANCE NEEDED.

UNDERSTAND RSO MAY FROM PANAMA ALREADY AT POST. PLEASE ADVISE
IF YOU WANT RSO TO COME.

2. LEGATT ROBERT OGLESBY WILL DEPART CARACAS ON NOVEMBER 20
ON PAMAN 445 AT 1820, ARR PORT OF SPAIN AT 1920.

WILL DEPART POS ON NOVEMBER 21 ON BWIA 461 AT 0545, ARR

GEORGETOWN 0745. PLEASE CONFIRM IF BWIA 461 WILL INDEED ARRIVE
IN GEORGETOWN AS SCHEDULED.

LIERS
58 NOV 28 1978

~~CONFIDENTIAL~~

FBI139

PAGE 01

STATE 294162

~~CONFIDENTIAL~~

ORIGIN ARA-15

Assoc. Dir.	_____
Dep. AD Adm.	_____
Dep. AD Inv.	_____
Asst. Dir.:	_____
Adm. Serv.	_____
Crim. Inv.	_____
Ident.	_____
Intell.	_____
Laboratory	_____
Legal Coun.	_____
Plan. & Insp.	_____
Rec. Mgnt.	_____
Tech. Servs.	_____
Training	_____
Public Affs. Off.	_____
Telephone Rm.	_____
Director's Sec'y	_____

70 NOV 23 1978
 RECEIVED
 FEDERAL BUREAU OF INVESTIGATION
 COMMUNICATIONS SECTION

INFO OCT-01 ISO-00 L-03 FBIE-00 SSO-00 CIAE-00 PA-01
 TRSE-00 DODE-00 MCT-02 INR-10 INRE-00 BURS-05 SYE-00
 USSS-00 H-01 SS-15 NSCE-00 CCO-00 OC-06 JUSE-00
 NSAE-00 ICAC-00 CG-00 DOTE-00 SCS-06 CA-01 /066

ALL INFORMATION CONTAINED
 HEREIN IS UNCLASSIFIED
 DATE 9/17/92 BY 1048 DKM/mdm

DRAFTED BY ARA; SSLEGT
 APPROVED BY ARA: JBUSHNELL

FEDERAL GOVERNMENT

L/ARA:FORTUNE (DRAFT)

FBI:SHAFFER (PHONE)
 GWG:RZIMMERMANN (DRAFT)

S/S-O - TGMARTIN

9/17/92 1048 DKM/mdm

-----120797-22236Z /14

O 202058Z NOV 78

FM SECSTATE WASHDC

Rymur

TO AMEMBASSY CARACAS IMMEDIATE
 AMEMBASSY PARAMARIBO IMMEDIATE
 AMEMBASSY PORT OF SPAIN IMMEDIATE
 AMEMBASSY BRIDGETOWN IMMEDIATE
 INFO AMEMBASSY GEORGETOWN IMMEDIATE

CINSOUTHCOM QUARRY HTS CZ
 CINMAC SCOTT AFB ILL
 US RED COM/RCJ2 MACDILL AFB FLA
 USCINCARRED FT MCPHERSON GA
 CDR 18TH AIRBORNE CORPS FT BRAGG NC

REC-130 89-4286-18

NOV 24 1978

b6 per FBI
 b7C

~~CONFIDENTIAL~~ STATE 294162

Declass per State let 2/16/2005

E.O. 11652: GDS UC65179DMH/ST/bpg

TAGS: CASC, OREP, GY

SUBJECT: GUYANA SITUATION

1. REPORTS AVAILABLE TO AMEMB GEORGETOWN SUGGEST POSSIBILITY
 THAT REVEREND JIM JONES AND/OR OTHER PT LEADERS MIGHT

58 NOV 21 1978

~~CONFIDENTIAL~~

~~CONFIDENTIAL~~

~~CONFIDENTIAL~~

~~CONFIDENTIAL~~

PAGE 02

STATE 294162

ATTEMPT TO LEAVE GUYANA BY BOAT.

2. BELIEVE YOU SHOULD ADVISE LOCAL AUTHORITIES OF THIS AND ALERT THEM TO POSSIBILITY THEY MIGHT SEEK TO LAND IN OR TRANSIT LOCAL TERRITORY.

3. FBI IS CURRENTLY INVESTIGATING TO SEE IF ANY VIOLATIONS OF US LAW HAVE OCCURRED. WE HAVE BEEN UNABLE TO CONFIRM FROM GOG WHETHER ARREST WARRANTS HAVE BEEN ISSUED FOR JONES OR OTHERS, BUT FEEL SUCH ACTION IS PROBABLE. VANCE

~~CONFIDENTIAL~~

2

~~CONFIDENTIAL~~

CONFIDENTIAL

FBB123

PAGE 01
ORIGIN ARA-15

STATE 293999

20 Nov 78 19 20z

INFO OCT-01 EUR-12 EA-10 ~~ORIN~~ ISO-00 SSO-00 NSCE-00
 INRE-00 ICAE-00 SCS-00 ~~ORIN~~ SY-05 FBIE-00
 SYE-00 PA-01 TRSE-00 MCT-02 AID-05 OC-06 CCO-00
 JUSE-00 CIAE-00 INR-10 NSAE-00 SVC-00 /086 R

DRAFTED BY ARA:JGRIFFITH

APPROVED BY ARA

S/S-O:

Rymur

Assoc. Dir.	
Dep. AD Adm.	
Dep. AD Inv.	
Asst. Dir.:	
Adm. Serv.	<input checked="" type="checkbox"/>
Crim. Inv.	<input checked="" type="checkbox"/>
Ident.	
Intell.	
Laboratory	
Legal Coun.	
Plan. & Insp.	
Rec. Mgmt.	
Tech. Servs.	
Training	
Public Affs. Off.	
Telephone Rm.	
Director's Sec'y	

b6 per FBI
b7c

ALL INFORMATION CONTAINED
 HEREIN IS UNCLASSIFIED
 DATE 9/17/92 BY 1046DKM/nda

0 20183 7Z NOV 78
FM SECSTATE WASHDC

FEDERAL GOVERNMENT

TO AMEMBASSY GEORGETOWN IMMEDIATE

INFO AMEMBASSY PANAMA IMMEDIATE

AMEMBASSY CARACAS IMMEDIATE

AMEMBASSY PORT OF SPAIN IMMEDIATE

AMEMBASSY LONDON IMMEDIATE

AMEMBASSY PARAMARIBO IMMEDIATE

AMEMBASSY KUWAIT IMMEDIATE

AMEMBASSY ABU DHABI IMMEDIATE

AMEMBASSY TEHRAN IMMEDIATE

AMEMBASSY TOKYO IMMEDIATE

REC-130

89-4286-19

22 NOV 24 1978

Declass per State let 2/16/2005
UC 65179 DMH/ST/bpg

CONFIDENTIAL STATE 293999

58 NOV 28 1978

LONDON FOR MICHAEL FINLEY, TOKYO FOR SENATOR HAYAKAWA

~~CONFIDENTIAL~~

E.O. 11652 GDS

TAGS: CASC, QREP, GY

SUBJECT: SITUATION REPORT NO. VII

REF: STATE 293803 AND PREVIOUS

1. THE GUYANESE CRISIS COMMITTEE HAS APPROVED OUR OFFER OF

~~CONFIDENTIAL~~

J

~~CONFIDENTIAL~~

~~CONFIDENTIAL~~

PAGE 02

STATE 293999

MEDICAL EVACUATION AND GRAVE REGISTRATION UNITS, INCLUDING UP TO 12 HELICOPTERS. THE NATIONAL MILITARY COMMAND CENTER (NMCC) IS MOBILIZING THE UNITS. THE HELICOPTERS ARE EXPECTED TO ARRIVE EARLY NOVEMBER 21.

2. OUR DCM TO PANAMA, WHO IS HELPING AT GEORGETOWN, AND A CONSULAR OFFICER ARE FLYING TO JONESTOWN THIS MORNING WITH THREE PRESS REPRESENTATIVES AND GUYANESE OFFICIALS AND WILL MAKE AN INITIAL ASSESSMENT OF THE SITUATION THERE. THEY ARE EXPECTED TO REPORT THEIR FINDINGS THIS AFTERNOON. ANOTHER FLIGHT WILL BRING OUR PATHOLOGICAL AND POISONS EXPERTS TO JONESTOWN THIS AFTERNOON. AMBASSADOR BURKE ALSO NOW ADVISES THAT THE 4-MAN DOD COMMUNICATIONS TEAM WILL FLY UP TO JONESTOWN TODAY. THEY ARE EXPECTED TO BEGIN TRANSMISSIONS FROM JONESTOWN THIS AFTERNOON.

3. THE AIR FORCE IS INVESTIGATING WHETHER THE MATTHEWS RIDGE AIR STRIP CAN TAKE AIRCRAFT AS LARGE AS C-130S SO THAT IT CAN BE USED AS A STAGING AREA FOR OPERATIONS IN JONESTOWN. THE AIR STRIP IS ABOUT 35 MILES AWAY FROM JONESTOWN, AND ITS USE WOULD CONSIDERABLY EASE SUPPLY PROBLEMS AND FACILITATE EVACUATION ACTIVITIES.

4. THE GUYANESE GOVERNMENT HAS REQUESTED THE LOAN OF TWO OTTER OR SIMILAR AIRCRAFT. THE AMERICAN PEOPLES TEMPLE CRISIS HAS OVERTAXED GUYANA'S DOMESTIC AIR TRANSPORT SYSTEM, WHICH IS CRITICAL FOR THE SUPPLY OF MANY ISOLATED GUYANESE COMMUNITIES. NMCC HAS NO OTTERS, BUT IS LOOKING INTO ALTERNATIVE WAYS OF RESPONDING TO THIS REQUEST.

5. AMBASSADOR BURKE ADVISES THAT AUTOPSIES HAVE BEEN PERFORMED ON THE BODIES OF CONGRESSMAN RYAN AND THE FOUR OTHERS KILLED DURING THE ATTACK AT PORT KAITUMA AND THAT

~~CONFIDENTIAL~~

3

~~CONFIDENTIAL~~

~~CONFIDENTIAL~~

PAGE 03

STATE 293999

~~CONFIDENTIAL~~

THEY ARE READY FOR TRANSPORT BACK TO THE UNITED STATES.
SCS IS COORDINATING THEIR MOVEMENT WITH THE NMCC. ALSO.
AMBASSADOR BURKE ADVISES THAT GUYANA WILL PROBABLY REQUIRE
THAT AUTOPSIES BE DONE ONLY ON A REPRESENTATIVE SAMPLE OF
THE DEAD AT JONESTOWN BEFORE AUTHORIZING THE RETURN OF THE
BODIES TO THE UNITED STATES. VANCE

4

~~CONFIDENTIAL~~

~~CONFIDENTIAL~~

FBB079

PAGE 01 STATE 293790
ORIGIN ARA-15

20 Nov 78 02 35

~~CONFIDENTIAL~~

Assoc. Dir.	
Dep. AD Adm.	
Dep. AD Inv.	
Asst. Dir.:	
Adm. Serv.	<input checked="" type="checkbox"/>
Crim. Inv.	<input checked="" type="checkbox"/>
Ident.	
Intell.	
Laboratory	
Legal Coun.	
Plan. & Insp.	
Rec. Mgnt.	
Tech. Servs.	
Training	
Public Affs. Off.	
Telephone Rm.	
Director's Sec'y	

INFO OCT-01 EUR-12 EA-10 NECOMMUNICATIONS SECTION CIAE-00 DODE-00
 NSAE-00 NSCE-00 SSO-00 ICAE-00 INRE-00 FBIE-00
 PA-01 TRSE-00 SCS-06 CA-01 MCT-02 SY-05 SYE-00

USSS-00 H-01 AID-05 SS-15 OC-06 CCO-00 PM-05
 JUSE-00 SVC-00 /096 R

RECEIVED
 FEDERAL BUREAU
 OF INVESTIGATION
 COMMUNICATIONS SECTION
 ALL INFORMATION CONTAINED
 HEREIN IS UNCLASSIFIED
 DATE 9/17/92 BY 1048 DCM/nidm

See

Rymur

[Redacted box]

DRAFTED BY ARA:JGRIFFITH
APPROVED BY ARA [Redacted]

S/S-0: [Redacted] b6 per FBI
b7C

-----094081 200223Z /64

O 20021'Z NOV 78

FEDERAL GOVERNMENT

RM SECSTATE WASHDC

TO AMEMBASSY GEORGETOWN IMMEDIATE
 AMEMBASSY PANAMA IMMEDIATE
 AMEMBASSY CARACAS IMMEDIATE

AMEMBASSY PORT OF SPAIN IMMEDIATE
 AMEMBASSY LONDON IMMEDIATE

AMEMBASSY PARAMARIBO IMMEDIATE

Declass per State let 2/16/2005
 UC 65179 DMH/ST/bpg

AMEMBASSY KUWAIT IMMEDIATE
 AMEMBASSY ABU DHABI IMMEDIATE
 AMEMBASSY TEHRAN IMMEDIATE

AMEMBASSY TOKYO IMMEDIATE

58 NOV 28 1978

~~CONFIDENTIAL~~ STATE 293790

~~CONFIDENTIAL~~

9/17/92 1048 DCM/nidm
 REC-130
 89-4286-20

22 NOV 24 1978

W/S

LONDON FOR MICHAEL FINLEY, TOKYO FOR SENATOR HAYAKAWA

E.O. 11652: GDS

~~CONFIDENTIAL~~

TAGS: CASC, OREP (RYAN, LEO), GY

SUBJECT: SITUATION REPORT NO. IV

REF: STATE 293776 AND PREVIOUS

~~CONFIDENTIAL~~

~~CONFIDENTIAL~~

PAGE 02

STATE 293790

1. IN RESPONSE TO OUR OFFER OF ASSISTANCE, THE GUYANESE HAVE ASKED FOR TWO HELICOPTERS (EMBASSY GEORGETOWN IS OBTAINING SPECIFICS). COMMUNICATIONS EQUIPMENT, A SMALL AIRPLANE, OUTBOARD MOTOR, SLEEPING BAGS, ETC., ARE ALSO SOUGHT FOR THE POLICE FORCES NOW ON THEIR WAY TO JONESTOWN. THE NATIONAL MILITARY COMMAND CENTER IS PROCESSING THESE REQUESTS, AND SUPPLIES ARE EXPECTED TO BEGIN MOVING TO GEORGETOWN SHORTLY.

~~CONFIDENTIAL~~

2

2. AT AMBASSADOR BURKE'S REQUEST, A SECOND C-141 MEDEVAC FLIGHT IS NOW SCHEDULED TO ARRIVE IN GEORGETOWN SHORTLY

AFTER DAYLIGHT ON NOVEMBER 20. THE FIRST MEDEVAC FLIGHT

IS SCHEDULED TO LAND AT ANDREWS AIR FORCE BASE AT 9:02 PM

THIS EVENING AND ASSISTANT SECRETARY WATSON AND OTHERS WILL MEET THE PLANE. EMBASSY GEORGETOWN REPORTS THAT

THE FIVE BODIES FROM THE ATTACK NOVEMBER 18 AT PORT KAITUMA HAVE NOW BEEN RETURNED TO GEORGETOWN. THE

INJURED WOMAN IN THE AIRCRAFT THAT ESCAPED FROM THE ATTACK

AT PORT KAITUMA HAS NOW BEEN IDENTIFIED. SHE IS

~~CONFIDENTIAL~~

[REDACTED] WHO WE PRESUME IS ONE OF THE JONESTOWN

b6 per FBI
b7C

RESIDENTS WHO CHOSE TO LEAVE WITH CONGRESSMAN RYAN. SHE IS REPORTED TO BE IN SERIOUS CONDITION IN THE GEORGETOWN PUBLIC HOSPITAL AND UNDER POLICE GUARD.

3. THE GUYANESE POLICE REPORT THAT SHARON AMOS, A

PEOPLES TEMPLE LEADER RESIDENT IN GEORGETOWN, KILLED

HER THREE CHILDREN AND COMMITTED SUICIDE ON NOVEMBER 18.

THE FATHER OF ONE OF THE CHILDREN TRAVELLED TO GEORGETOWN

WITH CONGRESSMAN RYAN AND IS STILL IN GUYANA. THE

POLICE ALSO REPORT THAT THEY HAVE ARRESTED IN GEORGETOWN AN AMERICAN PEOPLES TEMPLE MEMBER IN CONNECTION WITH THE

INCIDENT AT PORT KAITUMA.

~~CONFIDENTIAL~~

~~CONFIDENTIAL~~

3

~~CONFIDENTIAL~~

~~CONFIDENTIAL~~

PAGE 03 STATE 293790

4. EMBASSY GEORGETOWN HAS HAD NO REPORT OF THE GUYANESE POLICE AND MILITARY EXPEDITION WHICH LEFT FOR JONESTOWN AT 1300 WASHINGTON TIME, PROBABLY OWING TO LACK OF ADEQUATE COMMUNICATIONS EQUIPMENT AVAILABLE TO THE EXPEDITION.

4. IN TWO WELL-ATTENDED PRESS BRIEFINGS, DEPUTY DEPARTMENT SPOKESMAN TOM RESTON PROVIDED VIRTUALLY ALL AVAILABLE FACTS EXCEPT THE NAMES OF THE WOUNDED BEING EVACUATED IN THE C-141. NOW THAT THE WOUNDED HAVE BEEN EVACUATED FROM GUYANA, THE PRESS IS ALSO BEGINNING TO FOCUS ON THE PEOPLES TEMPLE, AND IS PUSHING FOR INFORMATION ABOUT THE GUYANESE POLICE AND MILITARY ON THEIR WAY TO JONESTOWN AND ABOUT WHAT IS GOING ON THERE.
VANCE

4

~~CONFIDENTIAL~~

PAGE 01

STATE 293803

~~CONFIDENTIAL~~

Assoc. Dir.	
Dep. AD Adm.	
Dep. AD Inv.	
Asst. Dir.:	
Adm. Serv.	
Crim. Inv.	
Ident.	
Intell.	
Laboratory	
Legal Coun.	
Plan. & Insp.	
Rec. Mgmt.	
Tech. Servs.	
Training	
Public Affs. Off.	
Telephone Rm.	
Director's Sec'y	

ORIGIN ARA-15

INFO OCT-01 EUR-12 EA-10 NEA-10 NOV 78 SO-10 850-00 NSCE-00

INRE-00 ICAE-00 SCS-06 CA-01 IRECH-01 SY-05 FBIE-00

SYE-00 PA-01 TRSE-00 MCF-02 NICAID-02 SECTION OC-06 CCO-00
JUSE-00 CIAE-00 INR-10 NSAE-00 / 086 R

ALL INFORMATION CONTAINED
HEREIN IS UNCLASSIFIED
DATE 9/12/92 BY 1048DKM/nda

DRAFTED BY ARA: JGR IFFITH

APPROVED BY ARA

S/S-0

b6 per FBI
b7C

DECLASSIFIED ON 9/12/92

-----097062 201458Z /53

O 201404Z NOV 78

FM SECSTATE WASHDC

FEDERAL GOVERNMENT

TO AMEMBASSY GEORGETOWN IMMEDIATE

AMEMBASSY PANAMA IMMEDIATE

AMEMBASSY CARACAS IMMEDIATE

AMEMBASSY PORT OF SPAIN IMMEDIATE

AMEMBASSY LONDON IMMEDIATE

AMEMBASSY PARAMARIBO IMMEDIATE REC-130

AMEMBASSY KUWAIT IMMEDIATE

AMEMBASSY ABU DHABI IMMEDIATE

AMEMBASSY TEHRAN IMMEDIATE

AMEMBASSY TOKYO IMMEDIATE

CONFIDENTIAL STATE 293803

LONDON FOR MICHAEL FINLEY, TOKYO FOR SENATOR HAYAKAWA

E.O. 11652: N/A

Declass per State let 2/16/2005
Uc 65179DMH/ST/bpg

TAGS: CASC, OREP (RYAN, LEO), GY

SUBJECT: SITUATION REPORT NO. VI

58 NOV 28 1978

~~CONFIDENTIAL~~

REFERENCE E 293800 AND PREVIOUS

THE GUYANESE GOVERNMENT HAS NOW GIVEN FINAL CLEARANCE FOR

~~CONFIDENTIAL~~

~~CONFIDENTIAL~~

~~CONFIDENTIAL~~

PAGE 02

STATE 293803

THE TWO HELICOPTERS THAT ARE PART OF THE ASSISTANCE PACKAGE
IT REQUESTED AND HAS ESTABLISHED A CABINET LEVEL CRISIS
COMMITTEE TO HANDLE THE PEOPLES TEMPLE CALAMITY. THE COM-
MITTEE IS HEADED BY MINISTER OF HEALTH, HOUSING, AND LABOR
HAMILTON GREEN AND INCLUDES THE MINISTERS OF FOREIGN AND
HOME AFFAIRS. GREEN IS KNOWN AS A DYNAMIC, CAPABLE ADMINI-
STRATOR. AMBASSADOR BURKE IS WORKING CLOSELY WITH THE
COMMITTEE WHICH IS NOW CONSIDERING OUR OFFER OF MEDICAL
HELICOPTER EVACUATION AND GRAVES REGISTRATION UNITS, IN-
CLUDING UP TO 12 HELICOPTERS. AN EARLY ANSWER IS EXPECTED,
AND THE NATIONAL MILITARY COMMAND CENTER IS PREPARING TO
HAVE THE UNITS READY TO MOVE QUICKLY. VANCE

2

~~CONFIDENTIAL~~

~~CONFIDENTIAL~~

FBB104

~~CONFIDENTIAL~~

Assoc. Dir.	
Dep. AD Adm.	
Dep. AD Inv.	
Asst. Dir.:	
Adm. Serv.	
Crim. Inv.	
Ident.	
Laboratory	
Legal Coun.	
Plan. & Insp.	
Rec. Mgmt.	
Tech. Servs.	
Training	
Public Affs. Off.	
Telephone Rm.	
Director's Sec'y	

PAGE 01

STATE 293800 20 Nov 78 13 43z

ORIGIN ARA-15

ALL INFORMATION CONTAINED
HEREIN IS UNCLASSIFIED
DATE 9/17/92 BY 1048 DKM/mdb
RECEIVED
FEDERAL BUREAU
OF INVESTIGATION
COMMUNICATIONS SECTION

INFO OCT-01 EUR-12 EA-10 NEA-11 ISO-00 SIG-03 H-01

FBIE-00 CIAE-00 DODE-00 NSAE-00 NSCE-00 SSO-00

ICAE-00 INRE-00 INR-10 PA-01 TRSE-00 SCS-06 CA-01

MCT-02 SY-05 SYE-00 USSS-00 AID-05 SS-15 OC-06

CCO-00 JUSE-00 SVC-00 /104 R

DRAFTED BY ARA [redacted]

FEDERAL GOVERNMENT

APPROVED BY ARA: AHEW IIT

S/S-0 [redacted]

b6 per FBI
b7C

O Rymur

(WLD)

9/17/92 / 1048 DKM/mdb

-----296140-201314Z 150

O 201142Z NOV 78
FM SECSTATE WASHDC

REC-130

TO AMEMBASSY GEORGETOWN IMMEDIATE

AMEMBASSY PANAMA IMMEDIATE
AMEMBASSY CARACAS IMMEDIATE
AMEMBASSY PORT OF SPAIN IMMEDIATE

AMEMBASSY LONDON IMMEDIATE
AMEMBASSY PARAMARIBO IMMEDIATE

AMEMBASSY KUWAIT IMMEDIATE

AMEMBASSY ABU DHABI IMMEDIATE
AMEMBASSY TEHRAN IMMEDIATE

AMEMBASSY TOKYO IMMEDIATE

Declass per State let 2/16/2005
UC 65179DMH/ST/bpg

89-4286-22

22 NOV 24 1978

mf

(Classified)
Ret...

~~CONFIDENTIAL~~ STATE 293800

58 NOV 29 1978

LONDON FOR MICHAEL FINLEY, TOKYO FOR SENATOR HAYAKAWA

~~CONFIDENTIAL~~

E.O. 11652: GDS

TAGS: CASC, CREP (RYAN, LEO), GY

~~CONFIDENTIAL~~

SUBJECT: SITUATION REPORT NO. V

REFERENCE: STATE 293790 AND PREVIOUS

~~CONFIDENTIAL~~

2

~~CONFIDENTIAL~~

~~CONFIDENTIAL~~

1. THE GUYANESE POLICE AND MILITARY FORCES HAVE ENTERED JONESTOWN AND REPORTEDLY ENCOUNTERED AS MANY AS 400 DEAD. FURTHER DETAILS FROM GUYANESE OFFICIALS ABOUT THE DEAD AND INFORMATION REGARDING REMAINING MEMBERS OF THE PEOPLES TEMPLE IN JONESTOWN ARE NOT YET AVAILABLE, AND DARKNESS AND HEAVY RAIN HAVE IMPEDED FURTHER MOVEMENT BY THE GOVERNMENT FORCES, PROBABLY UNTIL DAWN NOVEMBER 20. PRESS INQUIRIES ARE RELAYING RUMORS THAT ALL OF THE PEOPLES TEMPLE MEMBERS ARE DEAD. WE EXPECT TWO CONSULAR OFFICERS AND A U.S. COMMUNICATIONS TEAM TO REACH JONESTOWN THE MORNING OF NOVEMBER 20. GUIDANCE DEVELOPED FOR THE PRESS ON AN IF-ASKED BASIS IS: BEGIN QUOTE WE HAVE RECEIVED FROM OUR EMBASSY IN GEORGETOWN, GUYANA, A PRELIMINARY REPORT BY LOCAL OFFICIALS ON THE SCENE THAT IT APPEARS AS IF AS MANY AS 400 MEMBERS OF THE JONESTOWN PEOPLES TEMPLE COMMUNITY MAY BE DEAD. END QUOTE.

2. THE GOVERNMENT OF GUYANA HAS NOT GIVEN FINAL CLEARANCE FOR THE HELICOPTERS THAT FORM PART OF THE ASSISTANCE PACKAGE REQUESTED FOR THE GOVERNMENT FORCES. WE HAVE RECEIVED NO EXPLANATION FOR THE DELAYED APPROVAL. THE NATIONAL MILITARY COMMAND CENTER IS PREPARING TO PROVIDE A HELICOPTER SQUADRON (PERHAPS 12 HELICOPTERS) TO BE USED FOR EMERGENCY MEDICAL AND EVACUATION SERVICES TO SURVIVORS IN JONESTOWN SHOULD IT BE REQUIRED/

3. STATE HAS REQUESTED NMCC THAT A MILITARY GRAVES REGISTRATION TEAM AND NECESSARY EQUIPMENT SUCH AS BODY BAGS BE ASSEMBLED TO DEAL WITH THE MASSIVE PROBLEM OF BODY IDENTIFICATION AND DISPOSITION. SCS IS COORDINATING THESE ACTIVITIES WITH THE INTENTION OF BRINGING THE BODIES OF DEAD AMERICANS BACK TO THE US FOR BURIAL. A SECOND C-141 MEDEVAC PLANE IS SCHEDULED TO ARRIVE AT GEORGETOWN AT 9:00

CONFIDENTIAL

3

~~CONFIDENTIAL~~

~~CONFIDENTIAL~~

A.M. EST. CONGRESSMAN RYAN'S BODY AND THE REMAINS OF THE OTHER DEAD MAY BE BROUGHT OUT ON THIS PLANE.

4. SHORTLY AFTER 9:00 P.M. (EST) THE C-141 LANDED AT ANDREWS AIR FORCE BASE WITH FIVE WOUNDED FROM THE SHOOTING AT PORT KAITUMA, HAVING LEFT FOUR SERIOUSLY WOUNDED VIC-

TIMS IN PUERTO RICO FOR IMMEDIATE MEDICAL ATTENTION. THE CONDITION OF THOSE ARRIVING AT ANDREWS RANGED FROM HEAVILY SEDATED TO STUNNED, AND NONE SPOKE TO THE

PRESS. HOWEVER SAN FRANCISCO CHRONICLE CORRESPONDENT, RON JAVERS, THOUGH HIMSELF WOUNDED, FILED A LENGTHY AND LURID EYEWITNESS ACCOUNT OF THE EVENTS IN GUYANA AS THE

PLANE PASSED THROUGH PUERTO RICO. ASSISTANT SECRETARY BARBARA WATSON AND MEMBERS OF THE PRESS GREETED THE FLIGHT. THE C-130 FROM PANAMA WHICH CARRIED THE EMBASSY

AUGMENTATION TEAM TO GUYANA HAS TURNED AROUND IN GEORGETOWN AND IS SCHEDULED TO ARRIVE IN PUERTO RICO AT 5:56 AM LOCAL TIME, WITH EIGHT OF THE CONCERNED RELATIVES WHO HAD BEEN STAYING AT THE PEGASUS HOTEL IN GEORGETOWN.

5. OUR EMBASSY IN GEORGETOWN HAS PROVIDED AN UPDATE ON THE STATUS OF THOSE COMPOSING CODEL RYAN. ALL ARE ACCOUNTED FOR AS FOLLOWS AS OF 2:00 A.M. LOCAL TIME NOVEMBER 20:

CONG RYAN, DECEASED, REMAINS IN GEORGETOWN;
JACKIE SPEIER, WOUNDED, EVACUATED ON C-141;
MARK LANE, UNHURT, IN POLICE CUSTODY, GEORGETOWN;

CHARLES GARRY, UNHURT, IN POLICE CUSTODY, GEORGETOWN;
RICHARD DWYER, WOUNDED, AT HOME IN GEORGETOWN;
DON HARRIS, DECEASED, REMAINS IN GEORGETOWN;

BOB FLICK, UNHURT, DEPARTED GUYANA IN NBC JET;
RON JAVERS, WOUNDED, EVACUATED IN C-141;
TIM REITERMAN, WOUNDED, EVACUATED IN C-141;

CHARLES KRAUSE, UNHURT, IN GUYANA;
GREGORY ROBINSON, DECEASED, REMAINS IN GEORGETOWN;

STEVE SUNG, WOUNDED, EVACUATED ON C-141;

~~CONFIDENTIAL~~

~~CONFIDENTIAL~~

CONFIDENTIAL

PAGE 04

STATE 293800

BOB BROWN, DECEASED, REMAINS IN GEORGETOWN;
JAMES COBB, UNHURT, EVACUATED ON C-130 TO PUERTO RICO;
BEVERLY OLIVER, WOUNDED, EVACUATED ON C-141;
ANTHONY KATSARIS, WOUNDED, EVACUATED ON C-141;
CAROLYN BOYD, WOUNDED, EVACUATED ON C-141.

6. WE HAVE REMAINED IN CLOSE TOUCH WITH THE FBI AND THE
OFFICE OF CALIFORNIA GOVERNOR JERRY BROWN OUT OF CONCERN

THAT THE TRAGIC EVENTS IN GUYANA MIGHT BE EMULATED BY
PEOPLES TEMPLE MEMBERS IN CALIFORNIA. THUS FAR NO
SUCH EVENTS HAVE TAKEN PLACE.

7. THE GUYANA WORKING GROUP IS OPERATING CONTINUOUSLY AND
HANDLING INQUIRIES FROM THE PRESS AND OTHERS INCLUDING
RELATIVES OF PEOPLES TEMPLE MEMBERS. THE FOLLOWING
PHONE NUMBERS CAN BE USED FOR INCOMING CALLS: 632-9380

(1) (2) (3) AND 632-6615. VANCE

5

~~CONFIDENTIAL~~

UNCLASSIFIED

FBB 121

20 Nov 78 18 38z

PAGE 01

CARACA 10952 201723Z

FEDERAL BUREAU OF INVESTIGATION COMMUNICATIONS SECTION

ACTION SY-05

INFO OCT-01 SYE-00 ISO-00 FBIE-00 /006 W

-----099644 201829Z /47

O R 201640Z NOV 78
FM AMEMBASSY CARACAS

TO AMEMBASSY GEORGETOWN IMMEDIATE

INFO SECSTATE WASHDC 4685

UNCLAS CARACAS 10952

FOR /PSO FROM RSO

FEDERAL GOVERNMENT

ALL INFORMATION CONTAINED
HEREIN IS UNCLASSIFIED
DATE 11/17/92 BY 1042 DCA/ada

b6 per FBI
b7C

O Rymur

RSO

E.O. 11652: N/A

TAGS: ASEC

SUBJECT: LEGATT VISIT

REC-130

89-4286-23

MARY DELL HUMPHERY, SECRETARY, WILL ACCOMPANY LEGATT
OGLESBY ON NOVEMBER 21 ARRIVAL TO PROVIDE SECRETARIAL SUPPORT.

LUERS

22 NOV 24 1978

[Handwritten signature]

58 NOV 28 1978

Assoc. Dir.	
Dep. AD Adm.	
Dep. AD Inv.	
Asst. Dir.:	
Adm. Serv.	
Ident.	
Intell.	
Laboratory	
Legal Coun.	
Plan. & Insp.	
Rec. Mgnt.	
Tech. Servs.	
Training	
Public Affs. Off.	
Telephone Rm.	
Director's Sec'y	



PAGE 01
ORIGIN ARA-15

STATE 293798

20 Nov 78 10 30z

Assoc. Dir.	
Dep. AD Adm.	
Dep. AD Inv.	
Asst. Dir.:	
Adm. Serv.	
Crim. Inv.	
Ident.	
Intell.	
Laboratory	
Legal Coun.	
Plan. & Insp.	
Rec. Mgnt.	
Tech. Servs.	
Training	
Public Affs. Off.	
Telephone Rm.	
Director's Sec'y	

INFO OCT-01 ISO-00 SSO-00 CCO-00 SVC-00 FBIE-00 CIAE-00
 DODE-00 PA-01 TRSE-00 SCS-06 MCTU-02 CA-01 INR-10
 INRE-00 SY-05 SYE-00 USSS-00 H-01 AID-05 SS-15
 NSCE-00 JUSE-00 NSAE-00 ICAE-00 /002 R

DRAFTED BY ARA/CAR: AHEWITT
 APPROVED BY ARA/CAR: AHEWITT
 SAS-O: R CASTRODALE

ALL INFORMATION CONTAINED
 HEREIN IS UNCLASSIFIED
 DATE 9/17/92 BY 1008 DCM/ADM

-----095100 201021Z /11

O 200836Z NOV 78
FM SECSTATE WASHDC

FEDERAL GOVERNMENT

TO AMEMBASSY GEORGETOWN IMMEDIATE

Rymur *res*

LIMITED OFFICIAL USE STATE 293798

E.O. 11652: N/A

REC-130

89-4286-24

TAGS: GY

SUBJECT: LOCATION OF POSSIBLE SURVIVORS OF JONESTOWN
COMMUNITY

1. DEPARTMENT HAS BEEN INFORMED BY A CALIFORNIA BASED
 HAM RADIO OPERATOR WHO HAS MONITORED PEOPLES TEMPLE
 TRANSMISSIONS FROM GUYANA INTERMITTENTLY OVER THE PAST
 FOUR YEARS THAT THE PEOPLES TEMPLE HAS MAINTAINED TWO
 SATELLITE FARMS OR CAMPS WITHIN 75 TO 100 MILES OF
 JONESTOWN. IF THIS INFORMATION IS CORRECT SOME
 SURVIVORS OF THE JONESTOWN COMMUNITY MIGHT BE FOUND AT
 THESE LOCATIONS.

2. EMBASSY MAY WISH TO SEE IF THIS INFORMATION CAN BE
 VERIFIED, AND TO PASS IT ON TO GOG SECURITY FORCES IF
 IT SEEMS RELIABLE. VANCE

22 NOV 24 1978

res

58 NOV 23 1978

LIMITED OFFICIAL USE



DEPARTMENT OF STATE

Washington, D.C. 20520

7822355

FBI

FEDERAL GOVERNMENT

November 20, 1978

FBI
ALL INFORMATION CONTAINED
HEREIN IS UNCLASSIFIED
DATE 9/12/92 BY 1048OKA/mdm

DIST:

S
D
P
E
T
M
C
S/S
S/S-O
S/S-S
S/P
MILREP
ARA
CA
H
INR
M/CT
PA
PA/PRS
PA/HO
PM

St

MEMORANDUM FOR: ARA - Mr. Viron P. Vaky
Assistant Secretary

SUBJECT: Working Group Designation - Guyana

This is to record the authorization of the Deputy Secretary to establish, under your direction, a Working Group composed of representatives of ARA, CA, PA, H, and others as necessary, to deal with the current situation in Guyana. The effective time of authorization is 0700, November 19, 1978.

OR Y MUR

P. Tarnoff

res

Peter Tarnoff
Executive Secretary

AID
ICA
FBI
JUSTICE

WH (LDX)
DOD (LDX)
CIA (LDX)
NSA (LDX)

Working Group

REC-130

89 - 4286 - 25

2 NOV 24 1978

RES

58 NOV 28 1978

PAGE 01

GEORGE 03817 202214Z

ACTION ARA-15

INFO OCT-01 ISO-00 SCS-06 FBIE-00 ~~NOV 23 1978~~ DOTE-00 PA-00
 TRSE-00 MCT-02 CA-01 INR-10 INRE-00 SY-05 SYE-00
 USSS-00 H-01 AID-05 SS-15 SSO-00 NSCE-00 CCO-00
 OC-06 JUSE-00 NSAE-00 ICAC-00 SVC-00 L-03 CG-00
 DOTE-00 /071 W

Assoc. Dir.	
Dep. AD Adm.	
Dep. AD Inv.	
Asst. Dir.:	
Adm. Serv.	
Crim. Inv.	
Ident.	
Intell.	
Laboratory	
Legal Coun.	
Plan. & Insp.	
Rec. Mgnt.	
Tech. Servs.	
Training	
Public Affs. Off.	
Telephone Rm.	
Director's Sec'y	

-----101753 202218Z / 15
 ALL INFORMATION CONTAINED
 HEREIN IS UNCLASSIFIED
 DATE 9/17/92 BY 1048 DKM/nd

Z 202155Z NOV 78

FR AMEMBASSY GEORGETOWN
 TO SECSTATE WASHDC FLASH 8106 FEDERAL GOVERNMENT

Rymur *res*

LIMITED OFFICIAL USE GEORGETOWN 3817

E.O. 11652: N/A
 TAGS: CASC, OREP (RYAN, LEO)

REC-1241 89-4286

SUBJECT: IDENTIFICATION OF REVEREND JAMES JONES, HIS WIFE, A SON,
 AND ELEVEN BODYGUARDS AMONG DEAD PERSONS AT JONESTOWN.

22 NOV 24 1978

1. AT 1700 HRS LOCAL, POLICE COMMISSIONER LLOYD BARKER INFORMED
 EMBASSY PEOPLES' TEMPLE (PT) LEADER JAMES JONES, HIS WIFE,
 ONE SON, AND ELEVEN MEMBERS OF HIS BODYGUARD WERE IDENTIFIED AS
 AMONG THE DEAD AT JONESTOWN. BARKER SAID THAT REV. JONES HAD
 A BULLET IN THE HEAD. POLICE SUSPECT THAT AN ARGUMENT MAY HAVE
 DEVELOPED OVER A LARGE SUM OF MONEY THAT JONES INTENDED TO REMOVE
 FROM JONESTOWN AND HE MAY HAVE BEEN EXECUTED.

2. FYI: ACCORDING TO BARKER THE NATIONAL POLICE DISPATCHED A SIX-
 MAN TEAM TO JONESTOWN ON 20 NOVEMBER ALONG WITH SEVERAL PT
 ESCAPEES FROM JONESTOWN TO AID IN IDENTIFICATION EFFORTS. AMONG
 THE POLICE TECHNICIANS WERE TWO PHOTOGRAPHERS AND TWO FINGER-
 PRINT TECHNICIANS.

BURKE 0730
 all mmtsf
 58 NOV 28 1978
 LFS

CONFIDENTIAL

FBB118

~~CONFIDENTIAL~~

Assoc. Dir.	
Dep. AD Adm.	
Dep. AD Inv.	
Asst. Dir.:	
Adm. Serv.	
Crim. Inv.	
Ident.	
Intell.	
Laboratory	
Legal Coun.	
Plan. & Insp.	
Rec. Mgmt.	
Tech. Servs.	
Training	
Public Affs. Off.	
Telephone Rm.	
Director's Sec'y	

PAGE 01 GEORGE 03807 01 OF 02 201644Z
 ACTION ARA-15 20 NOV 78 10 25Z
 INFO OCT-01 ISO-00 FBIE-00 CIAE-00 DODE-00 PA-01
 TBSE-00 SCS-06 MCT-02 CA-01 IIR-10 IIRE-00 SY-05
 SYE-00 USSS-00 H-01 AID-05 SS-15 SSO-00 NSCE-00
 CCO-00 OC-06 JUSE-00 NSAE-00 ICAE-00 L-03 HA-05
 OPR-02 MED-05 PER-01 PPT-01 EUR-12 SMS-01 SM-05
 DEAE-00 / 103 W

0 201500Z NOV 78
 FM AMEMBASSY GEORGETOWN
 TO SECSTATE WASHDC IMMEDIATE 3090

ALL INFORMATION CONTAINED
 HEREIN IS UNCLASSIFIED 099086 201800Z /44
 DATE 9/17/97 BY 1048 DKA/hdm
 FEDERAL GOVERNMENT

ORy mur

b6 per FBI
 b7c

CONFIDENTIAL SECTION 1 OF 2 GEORGETOWN 3807

E.O. 11652: GDS
 TAGS: CASC, PINT, GY
 SUBJ: INTERVIEW WITH MARK LANE

9/17/97 1048 DKA/hdm
 EC-1241
 89-4286-27

MARK LANE WAS CONTACTED IN HIS HOTEL BY EMBASSY OFFICIALS AND HE READILY AGREED TO GIVE A STATEMENT TO THEM REGARDING THE INCIDENT IN JONESTOWN. LANE BEGAN HIS NARRATION BY DESCRIBING THE EVENTS AFTER THE DEPARTURE OF CONGRESSMAN RYAN HIS PARTY, AND THOSE MEMBERS OF THE PEOPLE'S TEMPLE WHO CHOSE TO GO WITH HIM.

22 NOV 24 1978

1. LANE STATED THAT HE AND HIS COLLEAGUE, CHARLES GARY, MET WITH JIM JONES AFTER CONGRESSMAN RYAN'S PARTY LEFT, AND ATTEMPTED TO PERSUADE HIM NOT TO TAKE DRASTIC MEASURES FOLLOWING THE DEPARTURE OF SOME OF HIS SECT'S MEMBERS. THE MEETING WAS INTERRUPTED BY MARIE KATSARIS WHO SAID "IT WAS IMPORTANT." AFTER A WHISPERED CONSULTATION BETWEEN JONES AND KATSARIS -- ACCORDING TO LANE -- JONES TOLD HIM AND GARY TO GO TO THE EAST CABIN BECAUSE THEY WERE IN DANGER. LANE SAID THE DON SLY, WHOM HE HAD HELPED TO DISARM IN THE FIRST ATTEMPT ON RYAN'S LIFE, WAS SENT TO GUARD THEM. LANE SAID HE THEN HEARD SHOUTS OF "DEATH IS A DIGNITY" AND "LET'S GET

ubs

Declass per State let 2/16/2005
 UC 65179DMH/ST/bpg

~~CONFIDENTIAL~~

58 NOV 28 1978

~~CONFIDENTIAL~~

~~CONFIDENTIAL~~

PAGE 02

GEORGE 03807 01 OF 02 201644Z

'EM NOW." AT FIRST, LANE SAID, HE THOUGHT THE THREAT WAS AIMED AT HIM AND GARY, BUT THE PEOPLE RUSHED PAST TO ANOTHER BUILDING WHERE THEY ALLEGEDLY WITHDREW GUNS AAND AMMUNITION. LANE STATED THAT SOME CRATES APPEARED TO BE SO HEAVY THAT TWO MEN COULD NOT CARRY THEM FOR MORE THAN A FEW YARDS AT A TIME. ALL THE PEOPLE HE COULD SEE, SAID LANE, WERE MOVING TOWARD A PAVILION ATOP A HILL.

2. LANE ALLEGES THAT TWO MEN KNOWN TO HIM, NAMED PANCHO AND THOMPSON, STOPPED TO SPEAK TO HIM AND HIS COLLEAGUE. HE REPORTED THAT ONE OF THEM, PANCHO, APPEARED TO BE VERY HAPPY AND SAID "IT'S A GREAT THING TO DIE, TO DIE WITH DIGNITY." LANE SAID THAT HE DISPUTED THIS IDEA SOMEWHAT WITH PANCHO, BUT THAT EVENTUALLY DECIDED TO FLEE THE AREA. HE ASKED FOR, AND RECEIVED, DIRECTIONS TO THE ROAD TO PORT KATUMA FROM PANCHO. LANE SAID THAT THOMPSON AT THIS POINT SHOUTED THAT "JIM JONES IS THE GREATEST MAN IN THE WORLD" AS THE TWO ATTORNEYS RAN FROM JONESTOWN.

3. AS THEY WERE LEAVING, LANE SAID, HE HEARD JIM JONES CHANT WHAT SOUNDED LIKE "MOTHER, MOTHER, MOTHER" OVER THE PA SYSTEM. WHEN ASKED IF JIM JONES HAD TO BE IN THE PAVILION TO USE THE PA SYSTEM, LANE REPLIED IN THE NEGATIVE, BUT INDICATED THAT HE FELT THAT JONES WAS IN THE PAVILION. LANE THEN ALLEGES THAT HE HEARD 80 TO 90 SHOTS.

4. LANE THEN BACKTRACKED IN TIME, AND SAID THAT JONES HAD SAID PRIOR TO THE INTERRUPTION BY MARIE KATSARIS, THAT THE PEOPLE WHO HAD LEFT HIS ORGANIZATION FOR CONGRESSMAN RYAN HAD DONE IT ONLY BECAUSE THEY PLANNED TO KILL RYAN, AND HE COULD PREDICT THAT THEY WOULD. LANE ALLEGES THAT HE DID NOT BELIEVE THE STORY OR THE "PROPHECY" AT THE TIME. HE FURTHER STATED THAT HE DID NOT LEARN OF THE AIRPORT ATTACK UNTIL HE

~~CONFIDENTIAL~~

~~CONFIDENTIAL~~

~~CONFIDENTIAL~~

WAS BACK IN GEORGETOWN.

5. LANE CONTINUED WITH HIS NARRATIVE OF HIS ESCAPE. HE SAID THAT HE AND GARY HAD WALKED ALONG THE ROAD, KEEPING WELL TO THE SIDE IN ORDER TO AVOID ANYONE ELSE. JUST AS IT WAS GETTING DARK, HE SAID THAT HE SPIED TWO MEN (BUT SAID THAT GARY BELIEVED IT WAS A GROUP OF THREE) ON THE ROAD CARRYING WHAT APPEARED TO BE FOOTLOCKERS. HE AND GARY SOUGHT SHELTER IN THE BUSH ALONG THE ROAD TO AVOID DETECTION AND REMAINED IN THE JUNGLE UNTIL EARLY MORNING. LANE INDICATED THAT THE SEEKING OF COVER HAD BEEN A TACTICAL MISTAKE BECAUSE IT TOOK THEM SEVERAL HOURS TO REGAIN THE ROAD. HE SAID THAT THE BUSH IS VERY THICK AND THE SENSE OF DIRECTION THROWN WAY OFF. AT ABOUT 7:45 ACCORDING TO LANE, HE HEARD ABOUT 15-25 ROUNDS OF AUTOMATIC FIRE, AND THEY FLED THE AREA AS FAST AS POSSIBLE.

6. IN REPLY TO A DIRECT QUESTION, LANE SAID THAT HE HAD ORIGINALLY THOUGHT THAT JONES HAD DIED ALONG WITH HIS SECT'S MEMBERS, BUT THAT HE BEGAN HAVING SECOND THOUGHTS AFTER SEEING THE LOCKERS BEING CARRIED THROUGH THE JUNGLE. HE KNOW FOR A FACT, HE SAID, THAT JONES HAD TWO OR THREE MILLION DOLLARS IN HIS CABIN. HE HAD NEVER SEEN IT, BUT ALLEGED THAT HE WAS SURE IT WAS THERE, AND EVEN KNEW WHO HAD BROUGHT IT INTO GUYANA AND HOW. HE DECLINED TO NAME THE SOURCE OF HIS INFORMATION, BUT SAID THAT HE WOULD DISCUSS IT WITH HIM AND PERHAPS IN EXCHANGE FOR IMMUNITY, THE INDIVIDUAL MIGHT EXPLAIN THE WHYS AND WHEREFORES.

7. AGAIN IN REPLY TO A DIRECT QUESTION, HE STATED THAT THE MEN CARRYING THE LOCKERS WERE HEADED IN THE GENERAL DIRECTION OF THE PLACE WHERE THE PEOPLE'S TEMPLE BOAT WAS MOORED, BUT ADMITTED THAT IT WAS ALSO IN THE GENERAL DIRECTION OF THE ROUTE HE WAS TAKING TO REACH PORT KAITUMA. HE REPEATEDLY DISCLAIMED ANY KNOWLEDGE OF A CONTINGENCY PLAN FOR JONES' ESCAPE, IN THE EVENT IT BECAME NECESSARY. HE SAID THAT JONES HAD TALKED OF SENDING A DELEGATION TO THE SOVIET UNION AND

~~CONFIDENTIAL~~

~~CONFIDENTIAL~~

~~CONFIDENTIAL~~

PAGE 04

GEORGE 03807 01 OF 02 201644Z

PERHAPS OF MOVING THE COMMUNE THERE, BUT HAD NEVER MENTIONED ANY PLANS INVOLVING HIS OWN ESCAPE.

8. WHEN ASKED IF HE HAD DETECTED ANY CHANGE IN THE ATMOSPHERE IN JONESTOWN DURING THE CONGRESSMAN'S VISIT, HE SAID NOT IN THE COMMUNITY IN GENERAL. HE ALLEGED, HOWEVER, THAT HE SENSED A CHANGE IN JIM JONES, THAT HE HAD SEEMED VERY CALM AND THAT HE (LANE) FELT THAT SOMETHING WAS GOING TO HAPPEN. HE THEN REPEATED JONES' "PREDICTION" OF TROUBLE FOR CONGRESSMAN RYAN AND PARTY.

4

~~CONFIDENTIAL~~

~~CONFIDENTIAL~~

FBB119

~~CONFIDENTIAL~~

PAGE 01 GEORGE 03807 02 OF 02 201630Z
ACTION ARA-15

INFO OCT-01 ISO-00 FBIE-00 CIAE-00 DODE-00 PA-01
TRSE-00 SCS-06 MCT-02 CA-01 INR-10 INRE-00 SY-05
SYE-00 USSS-00 H-01 AID-05 SS-15 SSO-00 NSCE-00
CCO-00 OC-06 JUSE-00 NSAE-00 ICAE-00 L-03 HA-05
OPR-02 MED-05 PER-01 PPT-01 EUR-12 SMS-01 SM-05
DEAE-00 /103 W

-----098741 201800Z /44

O 201500Z NOV 78

FM AMEMBASSY GEORGETOWN

TO SECSTATE WASHDC IMMEDIATE 8091

~~C O N F I D E N T I A L~~ SECTION 2 OF 2 GEORGETOWN 3807

9. LANE CHARACTERIZED THE LEADERSHIP GROUP AS A "COMMUNITY OF INSANITY." GROSS PARANOIA, HESTATED, SEEMED TO BE THE BADGE OF THE TRUE BELIEVER, AND THE SLIGHTEST SIGN THAT A PT LEADER DID NOT FEEL OPPRESSED ENOUGH WAS CAUSE FOR EXCLUSION FROM THE HIGHER ECHELON OF THE ORGANIZATION.

10. LANE SAID THAT WHEN HE FIRST BECAME INVOLVED WITH THE PT HE HAD BELIEVED THAT THE APPLAUSE AND RESPONSES TO JONES' WORDS WERE AUTHENTIC. SEVERAL WEEKS AGO, HOWEVER, HE FOUND OUT IT WAS ALL ARRANGED. HE STATED THAT HE HAD LEARNED OF THE STAGE MANAGING FROM A "HIGHLY-PLACED PERSON" WHO HAD LEFT THE ORGANIZATION. WHEN ASKED, THEN, WHY HE HAD WORKED SO HARD TO ARRANGE THE FACT-FINDING MISSION OF CONGRESSMAN RYAN, HE STATED THAT HE THOUGHT HE SHOULD TRY TO HELP SOME OF THE PEOPLE LEAVE JONESTOWN. HE WENT ON TO STATE THAT DON HARRIS (ONE OF THE NBC NEWSMEN KILLED AT THE AIRPORT ATTACK) HAD TOLD HIM THAT THE GUYANESE POLICE HAD REPORTEDLY SAID THAT THERE WERE NUMEROUS WEAPONS AT JONESTOWN, INCLUDING AUTOMATIC RIFLES AND HE HAD BEGUN TO WORRY.

11. IN RESPONSE TO A QUESTION REGARDING THE MASS SUICIDE IDEA, LANE DESCRIBED THE SENSE OF COMMUNITY FELT BY MEMBERS OF

~~CONFIDENTIAL~~

5

~~CONFIDENTIAL~~

~~CONFIDENTIAL~~

PAGE 02

GEORGE 03807 02 OF 02 201630Z

~~CONFIDENTIAL~~

THE TEMPLE, BY RECOUNTING A SERVICE HE HAD WITNESSED AT ONE TIME IN SAN FRANCISCO WHERE THREE WOMEN HAD ATTESTED TO JONES' REMARKABLE SEXUAL ENDOWMENT AND PROWESS, AND JONES' STATEMENT THAT HIS SEXUAL LIAISON WITH THE WOMEN WAS VERY DISTASTEFUL TO HIM PERSONALLY BUT THAT HE HAD DONE IT FOR THE GOOD OF THE

COMMUNITY. LANE STRESSED THAT SUCH A BIZARRE COMMITMENT

INDICATED THAT FEELINGS WERE VERY STRONG. HE DID NOT, HOWEVER, FEEL THAT THE COMMITMENT RAN TO A SUICIDE PACT, AND REPEATED THAT "REVOLUTIONARY SUICIDE" WAS SUICIDE AT THE POINT OF A

GUN. HE INDICATED THAT SUCH TRUE BELIEVERS COULD BE INDUCED TO COMMIT SUICIDE BUT DISCOUNTED THE IDEA THAT THERE WOULD BE

MASS SUICIDE IN OTHER AREAS. HE ADDED, HOWEVER,

THAT HE WAS SURPRISED AT SHARON AMOS' ACTION. STATED THAT THE DOCTOR, NAMED "LARRY", AND HIS NURSE HAD BROUGHT UP AN UNSPECIFIED POISON IN "A TUB", AND WERE PREPARED TO ADMINISTER

IT TO THE INHABITANTS OF JONESTOWN. THE POISON WAS TO BE SPRAYED INTO THE MOUTHS OF THE CHILDREN, AND THOSE WHO RESISTED WERE TO BE SHOT, HE ALLEGED. WHEN ASKED "WHY SPRAYED INTO THE

MOUTHS", HE REPLIED THAT HE DIDN'T KNOW, NOR DID HE KNOW THE TYPE OF POISON REFERRED TO.

12. TOWARD THE END OF THE CONVERSATION LANE STATED THAT THE DOCTOR, LARRY, WAS NOT ALLOWED TO HANDLE ANY DRUGS, SINCE HE WAS A FORMER ADDICT. THE NURSE HANDLED ALL DRUGS. HE THEN

ASKED RHETORICALLY IF WE KNEW THAT JONES WAS TAKING SHOTS INTRAVANEOUSLY FOR THE LAST SEVERAL WEEKS, AND SAID THAT HE WAS NOT UNDER MEDICATION FOR HIS HEALTH. REFERRING BACK TO

HIS DESCRIPTION OF PANCHO'S EUPHORIC STATE WHEN THE GUNS AND AMMUNITION WERE TAKEN OUT, ONE OFFICIAL ASKED IF PANCHO AND PERHAPS THE OTHER MEMBERS OF THE PEOPLE'S TEMPLE HAD TAKEN

DRUGS ON THE EVENTFUL DAY. HE REPLIED BY SAYING THAT HE HAD BEEN WARNED (TIME UNSPECIFIED) NEVER TO EAT GRILLED CHEESE SANDWICHES OR DRINK MILK SHAKES THERE. THAT IS WHAT WAS

~~CONFIDENTIAL~~

6

~~CONFIDENTIAL~~

~~CONFIDENTIAL~~

~~CONFIDENTIAL~~

PAGE 03

GEORGE 03807 02 OF 02 201630Z

OFFERED FOR LUNCH THAT DAY, SO HE DIDN'T TOUCH IT. HE MUSED
ABOUT THE POSSIBILITY OF THE PARTICULAR FOODSTUFFS HIDING
OTHER TASTES.

BURKE

~~CONFIDENTIAL~~

7

Assoc. Dir.	
Dep. AD Adm.	
Dep. AD Inv.	
Asst. Dir.:	
Adm. Serv.	
Crim. Inv.	
Ident.	
Intell.	
Laboratory	
Legal Coun.	
Plan. & Insp.	
Rec. Mgnt.	
Tech. Servs.	
Training	
Public Affs. Off.	
Telephone Rm.	
Director's Sec'y	

PAGE 01

GEOR 03794 201205Z

ACTION SCS-06

INFO OCT-01 ARA-11 ISO-00 H-0201066785 12 SCB-00 SSO-00

CIAE-00 INR-10 NSAE-00 DODE-00 CIPA-01 FBIE-00

TRSE-00 CA-01 INRE-00 SY-05 MUNUSSS-00 SYE-00 OC-06

CCO-00 JUSE-00 ICAE-00 MCT-02 AID-05 DRC-01 /065

FEDERAL BUREAU OF INVESTIGATION

-----096180 201234Z /17

O 200550Z NOV 78
FM AMEMBASSY GEOR GET OWN

FEDERAL GOVERNMENT

TO SECSTATE WASHDC NIACT IMMEDIATE 8081

INFO 1300 MAS HOWARD AFB CZ/D00S

ALL INFORMATION CONTAINED
HEREIN IS UNCLASSIFIED
DATE 9/17/92 BY 1048 DIC/ldn

b6 per FBI
b7c

Rymur

AD

LIMITED OFFICIAL USE GEOR GET OWN 3794

CORRECTED COPY (EO TAGS AND SUBJ ADDED)

E.O. 11652: N/A

TAGS: CASC BY (PEOPLES' TEMPLE)

REC-1241

SUBJECT: SECURITY OF CONCERNED RELATIVES

89-4286-28

REF: (A) HOWARD AFB MSG DTG 200425Z NOV 78

22 NOV 24 1978

(B) GEORGETOWN 3791 (DTG 200330Z NOV 78)

1. SINCE REF B. C-130 HAS BEEN REROUTED TO PUERTO RICO INTL AIRPORT VICE PANAMA CANAL ZONE.

2. C-130'S ETD GEORGETOWN 0600Z AND ETA PUERTO RICO 0900Z.

3. FOR HOWARD AFB: REF A ACKNOWLEDGED

AND EXECUTED
BUR KE

58 NOV 28 1978

UNCLASSIFIED

FBB078

Assoc. Dir.	
Dep. AD Adm.	
Dep. AD Inv.	
Asst. Dir.:	
Adm. Servs.	
Crim. Inv.	
Ident.	
Intell.	
Laboratory	
Legal Coun.	
Plan. & Insp.	
Rec. Mgnt.	
Tech. Servs.	
Training	
Public Affs. Off.	
Telephone Rm.	
Director's Sec'y	

PAGE 01 STATE 293789

ORIGIN SCS-06

20 Nov 78 02 34

RECEIVED
FEDERAL BUREAU
OF INVESTIGATION

INFO OCT-01 ARA-15 ISO-00 COORDINATION SS-15 NSCE-00
 SSO-00 CIAE-00 INR-11 NSAE-00 DODE-00 PA-02
 FBIE-00 IRSE-00 MCT-02 INRE-00 SY-05 USSS-00
 AID-05 SYE-00 PPT-01 /065 R

FEDERAL GOVERNMENT

DRAFTED BY CA/SCS:RDBELT:BB

APPROVED BY ARA - JGRIFFITH

S/S-0



b6 per FBI
b7c

ALL INFORMATION CONTAINED
HEREIN IS UNCLASSIFIED
DATE 9/17/92 BY 1049 DCA/mjs

094046 200208Z /64

O 200200Z NOV 78

FM SECSTATE WASHDC

TO AMEMBASSY GEORGETOWN IMMEDIATE

ORymur

res

UNCLAS STATE 293789

E.O. 11652: N/A

REC-1241

89-4286-29

TAGS: CDES, GY, (AMOS, LINDA SHARON), (HARRIS, LIANE)

22 NOV 24 1978

SUBJECT: MURDER/SUICIDE AT PEOPLES TEMPLE GEORGETOWN
RESIDENCE

REF: GEORGETOWN 3789

6

DEPT UNABLE LOCATE NOK BASED ON INFO CONTAINED REFTEL.
 EMBASSY RESPECTFULLY REQUESTED ATTEMPT GET INFORMATION
 RE PPT NOS, NAMES AND ADDRESSES OF SHARON AMOS AND HER
 THREE CHILDREN IN U.S. PERHAPS SHERWIN HARRIS COULD
 PROVIDE THIS INFO. VANCE

58 NOV 28 1978

20 Nov 78 05 04z

RECEIVED
FEDERAL BUREAU
OF INVESTIGATION
COMMUNICATIONS SECTION

Assoc. Dir.	
Dep. AD Adm.	
Dep. AD Inv.	
Asst. Dir.:	
Adm. Serv.	
Crim. Inv.	
Ident.	
Intell.	
Laboratory	
Legal Coun.	
Plan. & Insp.	
Rec. Mgmt.	
Tech. Servs.	
Training	
Pub. Affs. Off.	
Telephone Rm.	
Director's Sec'y	

Handwritten signature

LIMITED OFFICIAL USE

FBB084

PAGE 01
ACTION SCS-06
GEORGE 03791 20042Z

FBI
ALL INFORMATION CONTAINED
HEREIN IS UNCLASSIFIED
DATE 9/17/92 BY 1048 DKM/nda

FEDERAL GOVERNMENT

INFO OCT-01 ARA-11 ISO-00 H-01 SS-15 NSCE-00 SSO-00
CIAE-00 INR-10 NSAE-00 DDE-00 PA-01 FBIE-00
TRSE-00 CA-01 INRE-00 SY-05 USSS-00 SYE-00 CCO-00
SVC-00 JUSE-00 ICAE-00 /051W

(red)

-----094193 200442Z /64

O 200330Z NOV 78

Orymur

FM AMEMBASSY GEORGETOWN
TO SECSTATE WASHDC NIACT IMMEDIATE 8078
INFO 1300 MAS HOWARD AFB CZ//DOOS

89 - 4286 - 30

22 NOV 24 1978

REC-1241

LIMITED OFFICIAL USE GEORGETOWN 3791

E.O. 11652: NA
TAGS: CASC, GT. (PEOPLES' TEMPLE)
SUBJE: SECURITY OF CONCERNED RELATIVES

Handwritten signature

REF: A) GEORGETOWN 3782 B) GEORGETOWN 3780
58 NOV 28 1978
C) GEORGETOWN 3789

1. GROUP OF CONCERNED RELATIVES AT THE PEGASUS HOTEL

CHANGED THEIR MINDS SINCE REFTEL AND NOW

WANT TO DEPART GUYANA. CONSULAR OFFICERS FROM

THE EMBASSY WENT BACK TO THE HOTEL, GATHERED

THEM UP, PUT THEM IN CARS WITH A POLICE

ESCORT, AND GOT THEM TO TIMHERI AIRPORT WHERE

THEY ARE DUE TO DEPART ON THE C-130 BRINGING IN

OUR TDY SUPPORT.

2. IT IS OUR UNDERSTANDING THAT THIS FLIGHT WILL

TERMINATE AT HOWARD AFB. THEY HAVE BEEN TOLD THAT

ONWARD TRANSPORTATION FROM THERE WILL BE AT THEIR

OWN EXPENSE VIA REGULAR COMMERCIAL CARRIERS.

3. THE GROUP IS COMPOSED OF:

LIMITED OFFICIAL USE

LIMITED OFFICIAL USE

PAGE 02

GEORGE 03791 200427Z

STOEN, TIMOTHY
STOEN, GRACE

THIELMAN, BONNIE

BOUQUET, CLARE
HOUSTON, NADYFE

PIETILLA, WAYNE

TOUCHETTE, MICKEY

4. ONE CONCERNED RELATIVE WHO WISHED TO DEPART

HAS BEEN PREVENTED FROM DOING SO AT THE AIRPORT
BY THE GUYANESE IMMIGRATION AUTHORITIES, HE IS

SHERWIN HARRIS, THE EX-HUSBAND OF SHARON AMOS

AND THE FATHER OF LIANE HARRIS. SEE GEORGETOWN
3789 (REF C)

5. THE PLANE IS DUE TO TAKE OFF WITHIN THE HOUR.
BURKE

LIMITED OFFICIAL USE

FBB083

20 Nov 78 05 04z

PAGE 01

GEORGE 03792 200427Z

ACTION SCS-06

FEDERAL BUREAU OF INVESTIGATION COMMUNICATIONS SECTION

Assoc. Dir.	
Dep. AD Adm.	
Dep. AD Inv.	
Asst. Dir.:	
Adm. Serv.	
Crim. Inv.	
Ident.	
Insp.	
Intell.	
Laboratory	
Legal Coun.	
Plan. & Insp.	
Rec. Mgmt.	
Tech. Servs.	
Training	
Public Affs. Off.	
Telephone Rm.	
Director's Sec'y	

INFO OCT-01 ARA-11 ISO-00 CIAE-00 DODE-00 NSAE-00

NSCE-00 SSO-00 ICAE-00 INRE-00 CA-01 FBIE-00 PA-01

TRSE-00 MCT-02 SY-05 SYE-00 USSS-00 H-01 AID-05
SS-15 CCO-00 OC-06 JUSE-00 /054 W

Handwritten initials/signature

-----094173 200436Z /64

Z 200355Z NOV 78

FM AMEMBASSY GEORGETOWN

TO SECSTATE WASHDC FLASH 8079

ALL INFORMATION CONTAINED
HEREIN IS UNCLASSIFIED
DATE 9/17/92 BY 1048 DCM/...

FEDERAL GOVERNMENT

Rymur

Handwritten initials in a circle

LIMITED OFFICIAL USE GEORGETOWN 3792

E.O. 11652: NA

TAGS: CASC, ORP (RYAN, LEO) GY *REC-1241*

SUBJ: CODEL RYAN: FIRST CASUALTY REPORT FROM JONESTOWN

89-4286-31

22 NOV 24 1978

1. FORMIN JACKSON INFORMED AMBASSADOR 0030 NOV 20 THAT INITIAL REPORT FROM GDF FORCES ENTERING JONESTOWN IS THAT

THERE ARE AT LEAST TWO TO THREE HUNDRED BODIES. NO FURTHER DETAILS AS YET. FORMIN

ASKED THAT PRESS RELEASE BE WITHHELD UNTIL

MORE SPECIFIC DETAILS KNOWN AND COORDINATED RELEASE CAN BE MADE.

NOV 28 1978

Handwritten signature

~~CONFIDENTIAL~~

20 Nov 78 06 02z

RECEIVED
FEDERAL BUREAU
OF INVESTIGATION
COMMUNICATIONS SECTION

Assoc. Dir.	
Dep. AD Adm.	
Dep. AD Inv.	
Asst. Dir.:	
Adm. Serv.	
Crim. Inv.	
Ident.	
Intell.	
Lab.	
Legal Coun.	
Plan. & Insp.	
Rec. Mgmt.	
Tech. Serv.	
Training	
Public Affs. Off.	
Telephone Rm.	
Director's Sec'y	

ALL INFORMATION CONTAINED
HEREIN IS UNCLASSIFIED
DATE 9/17/92 BY 1048DKM/ndm

FEDERAL GOVERNMENT

~~CONFIDENTIAL~~

FBB086

PAGE 01
ACTION SCS-06

GEORGE 03793 210546Z

9/17/92 1048DKM/ndm
RYMUR

INFO OCT-01 ARA-11 ISO-00 FBIE-00 CIAE-00 DODE-00 PA-01
 TRSE-00 MCT-02 CA-01 INR-10 INRE-00 SY-05 SYE-00
 USSS-00 H-01 AID-05 SS-15 SSO-00 NSCE-00 OC-06
 CCO-00 NSAE-00 ICAE-00 JUSE-00 SVC-00 /06A W

O 200535Z NOV 78

FM AMEMBASSY GEORGETOWN
TO SECSTATE WASHDC NIACT IMMEDIATE 8080

REC-124

89-4286-32

22 NOV 24 1978

~~CONFIDENTIAL~~ GEORGETOWN 3793

Declass per State let 2/16/2005
UC65179/DMH/ST/bpg

E.O. 11652: GDS

TAGS: CASC CDES GY (PEOPLES' TEMPLE), (CODEL RYAN)
SUBJECT: UPDATE ON PARTY THAT FLEW TO PORT KAITUMA WITH CODEL

58 NOV 29 1978

REF: GEORGETOWN 3775

~~CONFIDENTIAL~~

AS OF 0200 HOURS LOCAL, MONDAY, NOVEMBER 20:

CONG RYAN DECEASED REMAINS IN GEORGETOWN

JACKIE SPEIER WOUNDED EVACUATED ON C-141

MARK LANE UNHURT, IN POLICE CUSTODY, GEORGETOWN

CHARLES GRAY UNHURT IN POLICE CUSTODY GEORGETOWN

RICHARD DWYER WOUNDED AT HOME IN GEORGETOWN

DON HARRIS DECEASED REMAINS IN GEORGETOWN

BOB FLICK UNHURT DEPARTED GUYANA IN NBC JET

RON JAVERS WOUNDED, EVACUATED IN C-141

TIM REITERMAN WOUNDED EVACUATED ON C-141

CHARLES KRAUSE UNHURT IN GUYANA

GREGORY ROBINSON DECEASED REMAINS IN GEORGETOWN

STEVE SUNG WOUNDED EVACUATED ON C-141

BOB BROWN DECEASED REMAINS IN GEORGETOWN

JAMES COBB UNHURT EVACUATED ON C-130 TO PUERTO RICO

BEVERLY OLIVER WOUNDED EVACUATED ON C-141

ANTHONY KATSARIS WOUNDED EVACUATED ON C-141

CAROLYN BOYD WOUNDED EVACUATED ON C-141

~~CONFIDENTIAL~~

~~CONFIDENTIAL~~

~~CONFIDENTIAL~~

2

~~CONFIDENTIAL~~

~~CONFIDENTIAL~~

PAGE 02

GEORGE 03793 200546Z

GOG MOI OFFICIAL NO INFORMATION
BURKE

3

~~CONFIDENTIAL~~

Assoc. Dir.	
Dep. AD Adm.	
Dep. AD Inv.	
Asst. Dir.:	
Adm. Serv.	
Crim. Inv.	
Ident.	
Intell.	
Laboratory	
Legal Coun.	
Plan. & Insp.	
Rec. Mgmt.	
Tech. Servs.	
Training	
Public Affs. Off.	
Telephone Rm.	
Director's Sec'y	

PAGE 01 GEORGE 03794 200556Z

ACTION SCS-06

20 Nov 78 06 24z

INFO OCT-01 ARA-11 ISO-00 H-01 SS-15 NSCE-00 SSO-00

CIAE-00 INR-10 NSAE-00 DOD-00 PA-01 FBIE-00

TRSE-00 CA-01 INRE-00 SY-05 USSS-00 SYE-00 OC-06

CCO-00 SVC-00 JUSE-00 ICAE-00 MCT-02 AID-05 /064

RECEIVED
FEDERAL BUREAU OF INVESTIGATION
COMMUNICATIONS SECTION

-----094526 200603Z /17

0 200550Z NOV 78

FM AMEMBASSY GEORGETOWN

TO SECSTATE WASHDC NIACT IMMEDIATE 8081

INFO 1300 MAS HOWARD AFB CZ/DOOS

FEDERAL GOVERNMENT

ALL INFORMATION CONTAINED
HEREIN IS UNCLASSIFIED
DATE 9/17/92 BY 1048 DKM/ndm

Rymur

red

LIMITED OFFICIAL USE GEORGETOWN 3794

REF: (A) HOWARD AFB MSG DTG 200425Z NOV 78

(B) GEORGETOWN 3791 (DTG 200330Z NOV 78)

1. SINCE REF B. C-130 HAS BEEN REROUTED TO PUERTO RICO INTL AIRPORT VICE PANAMA CANAL ZONE.

2. C-130'S ETD GEORGETOWN 0600Z AND ETA PUERTO RICO 0900Z.

REC-124

89-4286-33

3. FOR HOWARD AFB: REF A ACKNOWLEDGED AND EXECUTED. BURKE

22 NOV 24 1978

NOTE BY OC/T: GEORGETOWN 3794 (#) TAGS, E.O., SUBJECT OMITTED. CORRECTION TO FOLLOW. 11/20/78 VMT.

[Handwritten signature]

58 NOV 28 1978

Assoc. Dir.	
Dep. AD Adm.	
Dep. AD Inv.	
Ass. Dir.:	
Ad. Aff.	<i>M/W</i>
Crim. Inv.	
Ident.	
Intell.	
Lab.	
Legal Coun.	
Plan. & Insp.	
Rec. Mgmt.	
Tech. Servs.	
Training	
Public Aff. Off.	
Telephone Rm.	
Director's Sec'y	

PAGE 01
ACTION ARA-15

GEORGETOWN 03812 201836Z

INFO OCT-01 ISO-00 FBIE-00 CIAE-00 DODE-00 PA-01
 TRSE-00 SCS-06 MCT-02 CA-01 INRE-00 SY-05
 SYE-00 USSS-00 H-01 AID-05 REG-SS-15 SSO-00 NSCE-00
 CCO-00 OC-06 JUSE-00 NSAE-00 ICAC-00 AS-02 L-03
 HA-05 MED-05 OPR-02 PER-01 CAPPT-01 DOTE-00 FAA-00
 EB-08 /095 W

20 NOV 78

-----100017 201917Z /44

0201755Z NOV 78

FM AMEMBASSY GEORGETOWN
TO CINCSOUTH IMMEDIATE

FEDERAL GOVERNMENT

50624

b6 per FBI
b7C

SECSTATE WASHDC IMMEDIATE 8095
DOD WASHINGTON (PASS NMCC) IMMEDIATE

ALL INFORMATION CONTAINED
HEREIN IS UNCLASSIFIED
DATE 9/17/92 BY 1048 DCK/...

LIMITED OFFICIAL USE GEORGETOWN 3812

Rymur

E.O. 11652: N/A
TAGS: CASC: OREP (RYAN)
SUBJECT: ASSISTANCE

REC-124j

89 -4286 -34

1. PORT KAITUMA AIRFIELD HAS THE CAPABILITY TO HANDLED ONLY SMALL
AIRCRAFT OF THE TWIN OTTER TYPE. THE AIR STRIP IS APPROXIMATELY
920 FT. IN LENGTH AND HAS A LOOSE, SOFT SURFACE.

22 NOV 24 1978

2. MAJ GODWIN MCPHERSON, COMMANDER, GDF, AIR WING, SOURCE OF

THIS INFORMATION RECOMMENDS MATTHEW'S RIDGE AIRFIELD AS ENTRY
POINT FOR LARGE EVACUATION TYPE AIRCRAFT. THIS FIELD IS 4,500
FEET IN LENGTH, HAS A HARD PACKED SURFACE AND CAN HANDLE C-130

AIRCRAFT. MAJ MCPHERSON NOTES, HOWEVER, THAT THERE ARE NO LANDING
LIGHTS AT EITHER AIRFIELD AND DAYLIGHT LANDINGS WILL BE NECESSARY,
UNLESS WE ARE PREPARED TO BRING IN PORTABLE LIGHTS FOR NIGHT

LANDINGS. HE WOULD WELCOME THE LATTER AND IS PREPARED TO ASSIGN
A SENIOR PILOT TO ASSIST U.S. PILOTS.

58 NOV 28 1978

LIMITED OFFICIAL USE

PAGE 02

GEORGE 03812 201836Z

3. WE ARE SENDING A QUALIFIED EMBASSY OFFICER TO EXAMINE BOTH
FIELDS AND WILL UPDATE THIS MESSAGE WHEN INFO BECOMES AVAILABWE.

BURKE

2

LIMITED OFFICIAL USE

FBB120

PAGE 01 GEORGE 03811 201817Z
ACTION ARA-15

20 Nov 78 18 38z

INFO OCT-01 ISO-00 FBIE-00 CIAE-00 DODE-00 PA-01
TRSE-00 SCS-06 MCI-02 FEDERAL BUREAU OF INVESTIGATION
COMMUNICATIONS SECTION INRE-00 SY-05
SYE-00 USSS-00 H-01 AID-05 SS-15 SSO-00 NSCE-00
CCO-00 OC-06 JUSE-00 NSAE-00 ICAE-00 L-03 HA-05
MED-05 OPR-02 PER-01 PPT-01 FAA-00 DOTE-00 EB-0

Assoc. Dir.	
Dep. AD Adm.	
Dep. AD Inv.	
Asst. Dir.:	
Adm. Serv.	
Crim. Inv.	
Ident.	
Intell.	
Laboratory	
Legal Coun.	
Plan. & Insp.	
Rec. Mgmt.	
Tech. Servs.	
Training	
Public Affs. Off.	
Telephone Rm.	
Director's Sec'y	

/093 W



b6 per FB
b7c

Z 201730Z NOV 78
FM AMEMBASSY GEORGETOWN
TO SECSTATE WASHDC FLASH 8094
DOD WASHDC/NMCC

09984 201825Z/44
ALL INFORMATION CONTAINED
HEREIN IS UNCLASSIFIED
DATE 9/17/92 BY: LOU8 DKA/mjd

FEDERAL GOVERNMENT



Rymur

LIMITED OFFICIAL USE GEORGETOWN 3811

E.O. 11652:NA

TAG: CASC, OREP(RYAN, LEO) GY

SUBJ: GOG CREATES TASK FORCE TO DEAL WITH JONESTOWN TRAGEDY.

REF: GEORGETOWN 3792 REC-124

89-4286-35

22 NOV 24 1978

1. AMBA CALLED PRIME MINISTER EARLY MORNING TO DISCUSS
DEVELOPING JONESTOWN TRAGEDY NOVEMBER 20. (DURING THE NIGHT NOV.

19/20 GDF AND GUYANA PLICE HAD ENTERED JONESTOWN AND ESTABLISHED AS
MANY AS 300 TO 400 DEAD IN THE COMMUNITY.) AMBASSADOR SUGGESTED
TO PRIME MINISTER THAT IN ORDER TO COME TO GRIPS WITH THIS
CALAMITY IT WOULD BE USEFUL TO CREATE TASK FORCE THAT COULD
BE IN CONTINUOUS TOUCH TO MAKE NECESSARY ARRANGEMENTS
IN DAYS AHEAD. PRIME MINISTER IMMEDIATELY CREATED A TASK FORCE

COMPOSED OF MINISTER OF HEALTH, HOUSING AND LABOR HAMILTON
GREEN (CHAIRMAN), FOREIGN MINISTER RASHLIEGH JACKSON, AND MINISTER OF
HOME AFFAIRS VIBERT MINGO. FIRST MEETING WAS
SET FOR 0845.

2. AMBASSADOR AND ACTING DCM VICTOR DIKEOS ARRIVED AT MINISTER

LIMITED OFFICIAL USE

8 NOV 28

LIMITED OFFICIAL USE

PAGE 02

GEORGE 03811 201817Z

GREEN'S OFFICE FOR THE TASK FORCE'S FIRST MEETING. ALSO PRESENT WERE COMMANDER OF THE GUYANESE DEFENSE FORCE BRIGADIER PRICE, POLICE COMMISSION BARKER, GDF COLONEL JOSEPH SIGH (WHO HAD COMMANDED THE MOVEMENT INTO GEORGETOWN), AS WELL AS THE PERMANENT SECRETARY FOR THE PRIME MINISTER'S OFFICE.

3. GREEN OPENED THE MEETING BY NOTING THAT THE MOST IMMEDIATE PROBLEM SEEMED TO BE THE DISPOSITION OF THE 300 TO 400 RAPIDLY DECOMPOSING CADAVERS AT JONESTOWN. HE OUTLINED BRIEFLY TO THE GROUP THE PRIMITIVE COMMUNICATIONS AND TRANSPORTATION

LINKAGES FROM GEORGETOWN TO THE JONESTOWN AREA. HE ALSO SAID THAT AN ADDITIONAL CASUALTY DURING THE ATTACK ON CONGRESSMAN RYAN WAS

THE GUYANA AIRWAYS AIRCRAFT WHICH HAD TAKEN HIM TO PORT KAITUMA. IT WAS NOW SERIOUSLY DAMAGED AND OBVIOUSLY OUT SERVICE FOR SOME TIME. AS OF NOW GUYANA AIRWAYS CORPORATION WHICH FURNISHES INTERNAL DOMESTIC AIR SERVICE IN GUYANA IS VITUALLY OUT OF BUSINESS. THE MINISTER ASKED WHETHER OR NOT THE U.S.

GOVERNMENT WOULD BE IN A POSITION TO LOAN TO THE GOG TWO

OTTER AIRCRAFT (GAC KNOWS AND FLIES OTTERS ON ITS INTERNAL ROUTES) FOR A TEMPORARY PERIOD TO ENABLE THE GOVERNMENT OF

GUYANA TO RESTORE DOMESTIC AIR SERVICES. AMBASSADOR SAID THAT

HE WOULD TRANSMIT THIS REQUEST TO WASHINGTON.

4. AMBASSADOR OUTLINED FOR THE GROUP WHAT THE U.S. WAS INTENDING TO DO: ITEM: WE WERE BRINGING IN ADDITIONAL MEDEVAC C-141 DURING THE DAY OF NOV. 20. ITEM: WE WERE IN THE PROCESS OF BRINGING TWO UH1A INTO THE COUNTRY ALONG WITH AN L21. ITEM: TO HANDLE THE TRANSPORT OF THE BODIES FROM JONESTON TO TIMEHRI AIRPORT FOR EVENTUAL TRANSSPORT TO THE U.S. WE WERE PROPOSING TO BRING IN 12 HELICOPTERS PLUS SUPPORT AND OPERATING PERSONNEL. ITEM: IN RESPONSE TO GOG POLICE AND GDG MATERIAL REQUESTS, WE WERE

LIMITED OFFICIAL USE

2

LIMITED OFFICIAL USE

PAGE 03

GEORGE 03811 201817Z

BRINGING IN EQUIPMENT FOR THESE TWO SERVICES.

5. MINISTER PROPOSED SENDING INITIAL TEAM UP TO JONESTOWN TO MAKE OVERALL ASSESSMENT OF PROBLEM AT 10:30 LOCAL NOV. 20.

HE OFFERED TWO SPACES TO U.S. EMBASSY AND AMBASSADOR DESIGNATED

ACTING DCM DIKEOS AND TDY CONSUL JOHN NASH TO ACCOMPANY. AN ADDITIONAL GROUND TRIP BY THE ONE REMAINING OTTER IN THE GOG

INVENTORY WILL BE MADE MID-AFTERNOON AND WILL CARRY MEDICAL

PERSONNEL WHO WILL ATTEMPT TO BEGIN PROCESSING THE BODIES. (GOG HAS IN MIND TO SEPARATE POISON VICTIMS FROM GUNSHOT

VICTIMS AND PERFORM SPOT AUTOPSIES ON RANDOMLY SELECTED BODIES IN EACH GROUP FOR PURPOSES OF THEIR INVESTIGATION. OBVIOUSLY THERE IS NO INTENTION TO PERFORM AUTOPSIES ON ALL BODIES.) GOG HOPES TO BE ABLE TO PHOTOGRAPH AND FINGERPRINT ALL OF

THE VICTIMS.

6. WE WILL BE REPORTING FURTHER AS SOON AS ACTING DEPUTY CHIEF

OF MISSION DIKEOS RETURNS FROM JONESTOWN AREA. SEPARATE FROM THE TWO FLIGHTS REFERRED TO ABOVE EMBASSY HAS ON ITS OWN CHARTERED THE ONE AVAILABLE CESSNA 402 IN COUNTRY AND IS SENDING

USAF COMMO TEAM, WHICH ARRIVED NIGHT NOV. 19, TO JONESTOWN AT 1:30 P.M. LOCAL NOV 20. AMBASSADOR AND CONSUL HAVE BRIEFED

MILITARY PEOPLE ON WHAT TO EXPECT IN WAY OF TRANSPORTATION

PROBLEMS AND LIVING CONDITIONS ON ARRIVAL. COMMO TEAM IS HAPPILY, SELF-CONTAINED AND SELF-SUSTAINING, AT LEAST FOR 3-DAY PERIOD.

BURKE

3

UNCLASSIFIED

FBB 125

Assoc. Dir.	
Dep. AD Adm.	
Dep. AD Inv.	
Asst. Dir.:	
Adm. Serv.	
Crim. Inv.	
Ident.	
Intell.	
Laboratory	
Legal Coun.	
Plan. & Insp.	
Rec. Mgmt.	
Tech. Servs.	
Training	
Public Affs. Off.	
Telephone Rm.	
Director's Sec'y	

PAGE 01

GEORGETOWN NOV 28 1978 347 201945Z

ACTION ARA-15

RECEIVED
FEDERAL BUREAU
OF INVESTIGATION
COMMUNIST SECTION

INFO OCT-01 ISO-00 MURKIN-00 CIAE-00 DODE-00 PA-02

TRSE-00 SCS-06 MCT-02 CA-01 INR-10 INRE-00 SY-05

SYE-00 USSS-00 H-02 AID-05 SS-15 SSO-00 NSCE-00

CCO-00 OC-06 JUSE-00 NSAE-00 ICAE-00 L-03 HA-05

MED-05 OPR-02 PER-05 PPT-00 /090 W

b6 per FBI
b7c

0201925Z NOV 78

FEDERAL GOVERNMENT

FM AMEMBASSY GEORGETOWN

ALL INFORMATION CONTAINED
HEREIN IS UNCLASSIFIED
DATE 9/17/92 BY 10118DKM/mbn

TO SECSTATE WASHDC NIACT IMMEDIATE 8096

Rymur

UNCLAS GEORGETOWN 3813

E.O. 11652: N/A

TAGS: CDES, CASC, GY (PEOPLE'S TEMPLE)

REC-1241 89-4286-36

SUBJECT: ASSEMBLING NOX DATA AT GEORGETOWN

22 NOV 24 1978

REF: GEORGETOWN 3788

EMBASSY NOT RECEIVING AS MANY CALLS FROM RELATIVES OF PEOPLE'S
TEMPLE MEMBERS AS MIGHT BE EXPECTED. SUGGEST YOU CONSIDER

POSSIBILITY OF PUBLIC STATEMENT REQUESTING PEOPLE WITH RELATIVES
AT JONESTOWN TO CALL SOME WASHINGTON NUMBER WHERE DATA WILL BE
COMPILED AND TRANSMITTED TO US.

BURKE

58 NOV 28 1978

LIMITED OFFICIAL USE

F88256

Assoc. Dir.	
Dep. AD Adm.	/
Dep. AD Inv.	/
Asst. Dir.:	
Adm. Serv.	
Crim. Inv.	<i>M. J.</i>
Ident.	
Intel.	
Laboratory	
Legal Coun.	
Plan. & Insp.	
Rec. Mgmt.	
Tech. Servs.	
Training	
Public Affs. Off.	
Telephone Rm.	
Director's Sec'y	

PAGE 01 GEORGE 03846 01 OF 02 220042Z

ACTION SCS-06

FEDERAL BUREAU OF INVESTIGATION
COMMUNICATIONS SECTION

INFO OCT-01 ARA-11 ISO-00 CA-01 H-01 FBIE-00 SSO-00

NSCE-00 ICAE-00 INRE-00 CIAE-00 DODE-00 INR-10

NSAE-00 PA-01 SP-02 MCT-02 SY-05 SYE-00 CCO-00

CG-00 DOTE-00 AS-02 SS-15 /057 W

[Handwritten signature]

[Handwritten initials]

-----000646 220053Z /61

0 21220Z NOV 78

FM AMEMBASSY GEORGETOWN

TO SECSTATE WASHDC NIACT IMMEDIATE 8126

ORYMUR

FEDERAL GOVERNMENT

ALL INFORMATION CONTAINED
HEREIN IS UNCLASSIFIED
DATE 9/17/02 BY 1048DKM/jdk

REC-124

89-4286-357

22 NOV 24 1978

LIMITED OFFICIAL USE SECTION 1 OF 2 GEORGETOWN 3846

58 NOV 29 1978

[Handwritten signature]

ASX

0. 11652: N/A

TAGS: CASC (PEOPLE'S TEMPLE)

SUBJECT: IDENTIFIED DEAD

THE FOLLOWING ARE THE NAMES SUPPLIED BY THE COMMISSIONER OF POLICE OF THE IDENTIFIED DEAD AT JONESTOWN. WE BELIEVE IDENTIFICATION WAS MADE BY INDIVIDUALS WHO WERE FOUND ALIVE AT JONESTOWN.

NO.	NAME	SEX	AGE	CITY/STATE
1.	JIM ARTHUR JONES	M	13	
2.	PATRICIA CARTMELL	F	25	
3.	PATTY CARTMELL	F	50	
4.	RENEY KICE	F	30	
5.	BOB KICE	M	30	
6.	DAISY LEE	F	23	
7.	CHRISTINE LUCIENTES	F	27	
8.	PENNY KERNS	F	40	
9.	ALIZA SANTIAGO	F	20	
10.	KELVIN SMITH	M	27	

LIMITED OFFICIAL USE

LIMITED OFFICIAL USE

PAGE 02 GEORGE 03846 01 OF 02 220042Z

11. JACK BEAM	M	27
12. DAREL DAVERS	M	24
13. RICHARD TROPP	M	50
14. TOBI STONE	F	37
15. ELLEY BEAM	F	19
16. RAVINA BEAM	F	50
17. JOSALIN CARTER	F	22
18. ALYSON HLYGMAN	M	16
19. ALYVER MORGAN	M	24
20. KAWAN CARTER	F	2
21. LYDIA MORGAN	F	24
22. LIU JONES	M	22
23. TCHIOC JONES	M	1 1/2
24. TERRY JONES	F	20
25. ELLIHUE DENNIS	M	35
26. KERO DENNIS	F	35
27. MARY LIUCLANISE	F	22
28. ✓JOYCE TOUCHETTE	F	46
29. KAREN KERNS	F	19

30. KAREN LAYTON	F	19
31. KANNY FITCH	F	25
32. DON FITCH	M	27
33. ROSE PETERSON	F	78
34. CAROL STOLL	F	55
35. MR STOLL	M	60
36. WILLIE SNEED	M	65
37. SALEKO BOURDIANY	F	65
38. CLEVE SNEED	F	65
39. BEATRICE DAWKINS	F	60
40. JERALDINE BAILEY	F	62
41. AMANDA FAIR	F	70
42. DARELL KELLER	M	23
43. MILLER BRIDGEWATER	M	70

LIMITED OFFICIAL USE

PAGE 03

GEORGE 03846 01 OF 02 220042Z

44. BESSIE JOHNSON	F	50
45. L.C. MITCHELL	M	47
46. MRS MITCHELL	F	40
47. MRS PAR	F	80
48. STANLEY WRIGHT	M	19
49. MELANIE BRIDENBACK	F	19
50. MARY MAYSHACK	F	70
51. TONY JAMES	M	19
52. VIRGINIA MIDDLETON	F	63
53. MR FAIR	M	85
54. JACK BARREN	M	50
55. JANE MURCHMAN	F	27
56. ELOISE HALL	F	67
57. CARL HALL	M	74
58. YULADA BROWN	F	15
59. MARY DARDEN	F	40
60. ROBERT JOHNSON	M	15
61. MR LEWIS	M	
62. MARCUS ANDERSON	M	14
63. DOROTHY BUCKLY	F	16
64. EARL HINDS	M	60

501

65. MABLE HINDS	F	40	
66. CHRIS CORDELL	M	20	INDIANA
67. CATHY SURIFOI	F	24	
68. ROSIE RUGGERIO	F	22	CALIFORNIA
69. LIZABETH RUGGERIO	F	27	CALIFORNIA
70. MARY MARTIN	F	37	
71. GLADYS JACKSON	F		TEXAS
72. MISS ETTA	F	65	
73. FARRY NORWOOD	F	40	
74. ANADIA KELLY	F	27	
75. DEDE SMITH	F	40	
76. JOE BAYNE	M	30	
77. RONALD SINES	M	30	CALIFORNIA
78. NANCY SINES	F	28	
79. KIN BRUSTA	F	23	CALIFORNIA

LIMITED OFFICIAL USE

LIMITED OFFICIAL USE

PAGE 04 GEORGE 03846 01 OF 02 220042Z

80. DENNESE HUNTER	F	21	
81. CHRISTINE BATES	F	73	TEXAS
82. SUE GRIMM	F	37	CALIFORNIA
83. RANNIE BARRMAN	M	24	
84. WONDAR SOUNDER	F	25	CALIFORNIA
85. CLEEVE GASSIEA	M	22	BRITISH HONDURAS
86. MARY WATERSPOON	F	8	CALIFORNIA
87. MICHAEL SIMON	M	25	CALIFORNIA
88. THEICH LEROY	F	55	
89. MIKE LUND	M	22	
90. BILLY JONES	M	19	
91. LURETA CHAVOS	F	25	CALIFORNIA
92. JAMAL BASEY	M	10	CALIFORNIA
93. SANCHO JOHNSON	M	20	
94. KAY ROSA	F		
95. VARDELLA DUNCAN	F	55	
96. TENETRA FAIN	F	20	
97. NAWAB LAWRENCE	M	10	CALIFORNIA
98. MARIE LAWRENCE	F	35	CALIFORNIA
99. BOB RANKIN	M	36	
100. L.V. MCGUINES	M	70	

PAGE 01 GEORGE 03846 02 OF 02 220211Z

ACTION SCS-06

INFO OCT-01 ARA-11 ISO-00 CA-01 H-01 FBIE-00 SSO-00

NSCE-00 ICAE-00 INRE-00 CIAE-00 DODE-00 INR-10

NSAE-00 PA-01 SP-02 MCT-02 SY-05 SYE-00 CCO-00

CG-00 DOTE-00 AS-02 /042 W

-----001829 220215Z /73

O 212220Z NOV 78

FM AMEMBASSY GEORGETOWN

TO SECSTATE WASHDC NIACT IMMEDIATE 0000

LIMITED OFFICIAL USE SECTION 2 OF 2 GEORGETOWN 3846

- 101. AL TCHETTER M 70
- 102. DANNY CASSANOVA M 22
- 103. WESLEY BRYDENBACK M 22 CALIFORNIA
- 104. MITCHELLE TOUCHETTE F 25 INDIANA
- 105. PAULETTE JACKSON F 27 ALAMABA
- 106. BENN ROBERTSON M 27
- 107. ERIN LEROY F 23
- 108. GREGORY WATKINS M 24 MISSISSIPPI

8

109. EVELON EROY	M	27	
110. DANNY MOTON	M	24	CALIFORNIA
111. SHIRLEY FIELDS	F		
112. DANIELS FIELDS	M	22	CALIFORNIA
113. CARDELL NEIL	M	24	CALIFORNIA
114. RICKY CORY	M	19	
115. BILLY OLIVER	M	22	
116. LOIS PONTS	F H	50	CALIFORNIA
117. POP JACKSON	M	108	
118. LASSE LAYNE	F	85	
119. SUE NOXON	F	35	
120. LARY SCHATT	M	30	
121. CHRISTINE MILLER	F	55	
122. MARCILYN JONES	F	50	

LIMITED OFFICIAL USE

LIMITED OFFICIAL USE

PAGE 02 GEORGE 03846 02 OF 02 220211Z

123. PAT CRONETTE	M	45	
124. JIM JONES	M	45	
125. MARKS SLY	M	22	CALIFORNIA
126. JEROME ANDERSON	M	22	CALIFORNIA
127. TONY WALKER	M	21	CALIFORNIA
128. DAVID GEORGE	M	17	
129. EAD KRINSHAW	M		
130. AL SMITH	M		
131. TIMMY JONES	M	1975	SAN FRANCISCO
132. AMONDO GRIFFITH	M	27	CALIFORNIA
133. AMIS GRIFFITH	M		
134. TIM SWANEY	M		
135. AVIS GARCIA	M		
136. ALBERT TOUCHETTE	M	24	INDIANA
137. MARSHALL FARRIS	M	65	

138.	MAGNOLIA HARRIS	F	65	
139.	ANITA MARCH	F	18	
140.	KAREN LOUIS	F	18	
141.	TOMMY DELAHAUSSEY	F	14	
142.	AL BELL	M	30	
143.	TOM PARTAX	M	30	
144.	VERNON SMITH	M	80	
145.	SHIRLEY ANN EDWARDS	F	27	MISSISSIPPI
146.	FRACIS STEPHENS	M		
147.	DANNY KUTULAS	M		
148.	DOROTHY HARRIS	F		
149.	WALTER CARTMELL	M		
150.	MOREEN FITCH	F	29	CALIFORNIA
151.	CANDACE CORDELL	F	18	INDIANA
152.	DERRICK DAWSON	M		
153.	GARY TYLER	M		
154.	SSTANLEY GIDG	M		

LIMITED OFFICIAL USE

LIMITED OFFICIAL USE

PAGE 03 GEORGE 03846 02 OF 02 220211Z

155. JIMMY GILL	M		
156. CAROLENE LOOMAN	F		
157. LILLY VICTOR	F		
158. EDDY DENNIS	M		
159. TONY LINTON	M		
160. L. SMART	M		
161. BETTY BENDER	F		
162. HENRY GOMEZIE	M		
163. MONQUE BACON	F		
164. RUSSEL MOTEN	M		
165. LOUVINA JACKSON	F	81	
166. KEMBH REED	M		
167. DELMA DARNES	F		
168. WESLEY JOHNSON	M		
169. KEITH WADE	M		
170. WILLY GRADY	M		
171. BARBARA DAVIS	F	53	TEXAS
172. ROSIE KEATON	F		
173. DANNY MARSHALL	M		
174. VICKEY MARSHALL	M		

BURKE

12

Assoc. Dir.	
Dep. AD Adm.	
Dep. AD Inv.	
Asst. Dir.:	
Adm. Serv.	
Crim. Inv.	
Ident.	
Insp.	
Intell.	
Laboratory	
Legal Coun.	
Plan. & Insp.	
Rec. Mgmt.	
Tech. Servs.	
Training	
Public Affs. Off.	
Talent Dev.	
Director's Sec'y	

21 Nov 78 21 422

RECEIVED
 FEDERAL BUREAU OF INVESTIGATION
 COMMUNICATIONS SECTION
 LIMITED OFFICIAL USE FBB227

PAGE 01 GEORGE 03845 212120Z

ACTION SCS-06 FEDERAL GOVERNMENT

INFO OCT-01 ARA-11 ISO-00 CA-01 L-03 FBIE-00 CIAE-00
 INR-10 NSAE-00 PA-01 TRSE-00 H-01 AID-05 SS-15
 SP-02 CCO-00 SVC-00 DODE-00 NSCE-00 SSO-00
 ICAE-00 INRE-00 /056 W

b6 per FBI
 b7c

ALL INFORMATION CONTAINED
 HEREIN IS UNCLASSIFIED
 DATE 9/17/92 BY 1048 DKA/mch

-----128493 212129Z /14
 Rymur REC-1241 89-4286-38

Z 212120Z NOV 78
 FM AMEMBASSY GEORGETOWN
 TO SECSTATE WASHDC FLASH 8125

22 NOV 24 1978

LIMITED OFFICIAL USE GEORGETOWN 3845-01
 RECEIVED
 E.O. 11652: N/A
 TAGS: CASC, OREP (RYAN, LEO) GY
 58 NOV 28 1978
 SUBJECT: PEOPLES TEMPLE: DISPOSITION OF REMAINS

1. AT APPROXIMATELY 5:15 P.M. LOCAL AMBASSADOR RECEIVED MESSAGE CONVEYED OUT OF CABINET IN RESPONSE TO EARLIER REQUEST HE HAD MADE BY MINISTER HAMILTON GREEN THAT THE BODIES IN JONESTOWN BE INTERRED LOCALLY. THE MESSAGE WAS THAT CABINET HAD DECIDED THAT THEY WOULD LIKE ALL OF THE BODIES RETURNED TO THE U.S. AND AS SOON AS POSSIBLE. TO ASSIST IN THE ACCOMPLISHMENT OF THIS, THE GOVERNMENT WAS PREPARED TO RELAX NORMAL REGULATIONS SUCH AS THE IDENTIFICATION OF BODIES. THE PRINCIPAL REASON GIVEN FOR THE REFUSAL TO PERMIT LOCAL INTERMENT WAS GOG'S FEAR THAT THERE WOULD BE SUCH A FLOOD OF NEXT-OF-KIN WISHING TO VISIT THE JONESTOWN BURIAL SITE AND ASKING FOR THE DIS-INTERMENT OF BODIES OF THEIR RELATIVES THAT IT WOULD OVERTAX THE GOVERNMENT'S TRANSPORTATION AND ADMINISTRATIVE FACILITIES IN THAT PART OF GUYANA.

BURKE

LIMITED OFFICIAL USE

2

LIMITED OFFICIAL USE

FBB221

PAGE 01

GEORGE 03843 21200Z/Nov 78 20 22z

ACTION SCS-06

RECEIVED
FEDERAL BUREAU
OF INVESTIGATION
COMMUNICATIONS SECTION

Assoc. Dir.	
Dep. AD Adm.	
Dep. AD Inv.	
Asst. Dir.:	
Adm. Serv.	
Crim. Inv.	
Ident.	
Intell.	
Laboratory	
Legal Coun.	
Plan. & Insp.	
Rec. Mgmt.	
Tech. Servs.	
Training	
Public Affs. Off.	
Telephone Rm.	
Director's Sec'y	

INFO OCT-01 ARA-11 ISO-00 CCO-00 CA-01 L-03 FBIE-00

CIAE-00 INR-10 NSAE-00 INRE-00 PA-01 TRSE-00

MCT-02 SS-15 DODE-00 NSCE-00 SSO-00 ICAE-00 SY-05

SYE-00 USSS-00 AID-05 OC-06 JUSE-00 FM-05 H-01

/072 W

-----127562 212013Z /50

b6 per FBI
b7C

Z 211959Z NOV 78

FEDERAL GOVERNMENT

FM AMEMBASSY GEORGETOWN

TO SECSTATE WASHDC FLASH 8123

ALL INFORMATION CONTAINED
HEREIN IS UNCLASSIFIED
DATE 9/12/92 BY 1098 DCM/ndr

Rymur

LIMITED OFFICIAL USE GEORGETOWN 3843

89-4286-39

REC-126

22 NOV 24 1978

E.O. 11652: NA

TAGS: CASC, OREP (RYAN, LEO) GY

SUBJ: PEOPLES TEMPLE: DISPOSITION OF REMAINS.

REF: A. STATE 294528 B. GEORGETOWN 3826

✓ 1. MINISTER MAMILTON GREEN, CHAIRMAN OF THE GOG CABINET LEVEL COMMITTEE DESIGNATED TO ASSIST ON THE JONESTOWN TRAGEDY, BROKE OUT OF CABINET MEETING AT 2:30 P.M. LOCAL TIME TO MEET WITH ~~AGB~~ AND ACTING DCM TO DISCUSS VARIOUS ISSUES RELATED TO THE JONESTOWN EFFORT.

58 NOV 28 1978

2. AMB REVIEWED WITH HIM POINTS 1.A THROUGH 1.E OF REFERENCE A, AND ASKED WHETHER GUYANESE GOVERNMENT WOULD AGREE TO INTERMENT OF THE BODIES AT JONESTOWN IN GRAVES LOCATED ON THAT PROPERTY. MINISTER GREEN, WHO WAS GOING BACK INTO CABINET AFTER OUR MEETING, SAID THAT HE WOULD REFER THE MATTER TO THE PRIME MINISTER AND THE REST OF HIS COLLEAGUES AND PROVIDE AN ANSWER AS SOON AS THE CABINET MEETING IS OVER, SOMETIME LATER THIS AFTERNOON TOWARD 6 P. M. GREEN DID ASK SEVERAL QUESTIONS AND WHILE AMB AND ADCM WERE WITH HIM HE SUMMONED HIS PUBLIC

LIMITED OFFICIAL USE

2

PAGE 02

GEORGE 03843 212007Z

HEALTH ADVISER TO OBTAIN HIS ADVICE ON THE PROPOSAL. THE PUBLIC HEALTH OFFICER, CLAUDE MERRIMAN, WHO HAS BEEN A SENIOR ADVISER TO THE GOG ON A WIDE VARIETY OF ISSUES OVER THE YEARS, OPINED THAT THE INTERMENT WOULD BE POSSIBLE AND IN HIS ESTIMATION BURIAL OF ALL THE REMAINS COULD BE ACCOMPLISHED IN TWO DAYS USING MECHANICAL DIGGING EQUIPMENT.

3. IN THE EXPECTATION THAT THE CABINET DECISION WILL BE FAVORABLE MINISTER GREEN IS SCHEDULING A TRIP TO JONESTOWN AT 0700 NOVEMBER 22.

BURKE

NNNNVV AIA314ESA723

RR RUEHFB

DE RUESON #3841 2351815

ZNR UUUUU ZZH

R 211755Z NOV 78

FM AMEMBASSY GEORGETOWN

TO FBI HQ WASHDC

BT

UNCLAS GEORGETOWN 3841

E.O. 11652: N/A

TAGS:

SUBJECT: GUYANA-FOREIGN LIAISON MATTER

21 Nov 78 19 13z

RECEIVED
FEDERAL BUREAU
OF INVESTIGATION
COMMUNICATIONS SECTION

fb2
ALL INFORMATION CONTAINED
HEREIN IS UNCLASSIFIED
DATE 9/17/92 BY 1048DKM/ind
FEDERAL GOVERNMENT

Assoc. Dir.	_____
Dep. AD Adm.	_____
Dep. AD Inv.	_____
Asst. Dir.:	
Adm. Serv.	_____
Crim. Inv.	_____
Ident.	_____
Intell.	_____
Laboratory	_____
Legal Coun.	_____
Plan. & Insp.	_____
Rec. Mgnt.	_____
Tech. Servs.	_____
Training	_____
Public Affs. Off.	_____
Telephone Rm.	_____
Director's Sec'y	_____

Rymur

b6 per FBI
b7C

102

① [Redacted] Rm 5062

② [Redacted] Rm. 5015

REC-126 89-4286-40

1) LEGAT ROBERT J. OGLESBY, JR. AND STENO-SECRETARY
MARY DELL HUMPHREY ARRIVED GEORGETOWN, GUYANA, 2 AM
NOVEMBER 21, 1978, AND CAN BE REACHED CARE OF UNITED STATES
EMBASSY, PEGASUS HOTEL.

22 NOV 24 1978

BT

#3841

BURKE
BEVERLY

1/6

cc 58 NOV 30 1978

UNCLASSIFIED

FBB193

Assoc. Dir.	
Dep. AD Adm.	
Dep. AD Inv.	
Asst. Dir.:	
Adm. Serv.	<input checked="" type="checkbox"/>
Crim. Inv.	<input checked="" type="checkbox"/>
Ident.	<input checked="" type="checkbox"/>
Intell.	
Laboratory	
Legal Coun.	
Plan. & Insp.	
Rec. Mgmt.	
Tech. Servs.	
Training	
Public Affs. Off.	
Telephone Rm.	
Director's Sec'y	

PAGE 01

GEORGE 03820 211329Z
21 NOV 78 13 59z

ACTION ARA-15

INFO OCT-01 ISO-00 FBIE-00 CIAE-00 DODE-00 PA-22

IRSE-00 SCS-06 MCT-02 CA-01 INR-10 INRE-00 SY-05

SYE-00 USSS-00 H-02 AID-05 SS-15 SSO-00 NSCE-00

CCO-00 OC-06 JUSE-00 NSAE-00 ICAE-00 L-03 A-02

MED-05 OPR-02 PER-05 PPT-00 /087 W

-----118793 211338Z /41
O 210645Z NOV 78

FM AMEMBASSY GEORGETOWN
TO SECSTATE WASHDC IMMEDIATE 8109

ALL INFORMATION CONTAINED
HEREIN IS UNCLASSIFIED
DATE 9/12/92 BY 1048 DCM/ndr

b6 per FBI
b7C

FEDERAL GOVERNMENT

UNCLAS GEORGETOWN 3820

O Rymur

E.O. 11652: N/A

TAGS: CASC CDES GY (PEOPLES TEMPLE)
SUBJECT: DEPARTMENT ASSUMPTION OF DEATH AND W/W NOTIFICATION
RESPONSIBILITIES

REC-126

89-4286-41

REF: ELLICE/WARD TELECON 11/20/78

1. EMBASSY AGREES THAT DEPARTMENT MUST ASSUME RESPONSIBILITY FOR
NOTIFYING RELATIVES OF BOTH DEAD AND SURVIVING PEOPLES TEMPLE
MEMBERS. PLEASE CONFIRM BY TELEGRAM. FUTURE CALLERS FROM

STATES WILL BE TOLD TO CALL DEPARTMENT. MOST OF TELEPHONES
CONNECTIONS WE HAVE EXPERIENCED WITHIN THE LST FEW DAYS HAVE
BEEN UNINTELLIGIBLE ANYWAY.

22 NOV 24 1978

2. THIS CANCELS GEORGETOWN 3813
BURKE

[Handwritten signature]

58 NOV 28 1978

UNCLASSIFIED

LIMITED OFFICIAL USE

FBB192

PAGE 01

GEORGE 03826

21 Nov 78 14 00Z
211328Z

ACTION SCS-06

FEDERAL BUREAU OF INVESTIGATION
COMMUNICATIONS SECTION

INFO OCT-01 ARA-11 ISO-00 CA-01 L-03 FBIE-00 CIAE-00
INR-10 NSAE-00 PA-01 TRSE-00 DODE-00 NSCE-00
SSO-00 ICAE-00 INRE-00 H-01 AID-05 SS-15 SP-02
CCO-00 / 056 W

Assoc. Dir.	
Dep. AD Adm.	
Dep. AD Inv.	
Asst. Dir.:	
Adm. Serv.	
Crim. Inv.	<i>[initials]</i>
Ident.	
Int'l.	
Laboratory	
Legal Coun.	
Plan. & Insp.	
Rec. Mgmt.	
Tech. Servs.	
Training	
Public Affs. Off.	
Telephone Rm.	
Director's Sec'y	

-----118785 211335Z /41

Z 211235Z NOV 78
FM AMEMBASSY GEORGETOWN

FBI
ALL INFORMATION CONTAINED
HEREIN IS UNCLASSIFIED
DATE 9/17/92 BY 10480KM/mdm
b6 per FBI
b7c

TO SECSTATE WASHDC FLASH 8112

FEDERAL GOVERNMENT

LIMITED OFFICIAL USE GEORGETOWN 3826

Rymur

E.O. 11652: N/A
TAGS: CASC, OREP (RYAN LEO) GY

SUBJECT: PEOPLES TEMPLE; DISPOSITION OF REMAINS.

REF: STATE 294528

1. EMBASSY AGREES ENTIRELY WITH THE COURSE OF ACTION SET FORTH IN REFTEL. EYE WITNESS REPORTS BY ACTING DCM VICTOR DIKEOS AND CONSUL JOHN ADAMS HAD ALREADY CONFIRMED THAT THE SITUATION AT JONESTOWN IS ALREADY CRITICAL, PARTICULARLY IN TERMS OF THE POTENTIAL HEALTH HAZARD AND THE PROBLEM OF IDENTIFICATION OF REMAINS.

2. AMBASSADOR I REQUESTING URGENT APPOINTMENT WITH MINISTER HAMILTON GREEN, CHAIRMAN OF THE GOG TASK FORCE. AT THIS MEETING AMBASSADOR WILL MAKE POINTS SET FORTH IN

22 NOV 24 1978

✓ PARA 1 REFTEL. AT THE SAME TIME IT IS ESSENTIAL THAT WE BE ABLE TO ASSURE GOG THAT U.S. RESOURCES ALREADY IN COUNTRY AND THOSE DUE TO ARRIVE WITHIN THE NEXT 48 HOURS BE MADE AVAILABLE FOR THE ACCOMPLISHMENT OF THE LOCAL

INTERNMENT OPERATION. WE MUST NOT GIVE THE IMPRESSION THAT WE ARE NOW INCAPABLE OF DEALING WITH THE

OF THESE SOURCES ON 12/2/78

PAGE 02

GEORGE 03826 211328Z

LOCAL BURIAL OPTION WITH MINISTER GREEN, I REQUEST AUTHORITY TO BE ABLE TO ASSURE HIM ON THIS POINT WHICH IS CERTAIN TO ARISE.

3. ASSUMING GOG CONCURRENCE, WE WILL THEN MOVE AT ALL POSSIBLE SPEED TO ACCOMPLISH LOCAL INTERNMENT IN COMPLIANCE WITH LOCAL LAW AND WITH THE UNDERSTANDING THAT DIS-

INTERNMENT WOULD BE POSSIBLE IN THE FUTURE IN

INDIVIDUAL CASES IF THE NEXT OF KIN REQUESTED AND WOULD BE WILLING TO BEAR THE EXPENSE. IN ACCOMPLISHING LOCAL INTERNMENT EVERY EFFORT WILL BE MADE TO IDENTIFY THE

REMAINS AND SUITABLE MARKERS FOR THE INDIVIDUAL GRAVES WILL BE SET IN PLACE. IT MUST BE NOTED,

HOWEVER, THAT SEVERAL OF THE BODIES HAVE DECOMPOSED

TO THE POINT WHERE IDENTIFICATION WILL BE EXTREMELY DIFFICULT OR IMPOSSIBLE. WE MUST BE PREPARED,

THEREFORE, FOR THE POSSIBILITY THAT AS MANY AS 20-25 PERCENT OF THE BODIES MAY NEVER BE IDENTIFIED.

4. UNDOUBTEDLY THE LOCAL INTERNMENT OPTION WILL NOT

BE POPULAR IN SOME QUARTERS. NEVERTHELESS, IN VIEW OF THE ACUTE HEALTH PROBLEM THAT IS GROWING WITH EVERY PASSING HOUR, THAT OPTION SEEMS TO US TO BE INTIRELY DEFENSIBLE ON HEALTH AND HUMANITARIAN GROUNDS. THE DEPARTMENT SHOULD BE AWARE

THAT GEORGETOWN IS STILL FLOODED WITH FOREIGN PRESS

IN SEARCH OF ANY STORY IN CONNECTION WITH THIS DISASTER. WERE THEY TO HAVE AN IMPRESSION THAT

THE USG IS BACKING AWAYFROM ITS ORIGINAL COMMITMENT

TO BE DIRECTLY AND IMPORTANTLY INVOLVED WITH THE DISPOSITION OF REMAINS, THEY WOULD BE QUICK TO FOCUS

ON THAT. FURTHERMORE, WE HAVE ALREADY SOME NEXT OF KIN ARRIVING IN GEORGETOWN FROM THE U.S. BECAUSE

LIMITED OFFICIAL USE

PAGE 03

GEORGE 03826 211328Z

OF THE INACCESSIBILITY OF JONESTOWN, THEY HAVE BEEN
PRESSING US TO PROVIDE TRANSPORTATION TO THE SITE AND
IN SOME CASES MAY BE REQUESTING IMMEDIATE SHIPMENT
OF REMAINS TO THE U. S. THIS IS OBVIOUSLY BEYOND ANY
GUYANESE FUNERAL CAPABILITY. IT IS IMPORTANT
THEREFORE THAT THEY BE MADE AWARE THAT THE USG IS
MOVING PROMPTLY, WITH THE GUYANESE GOVERNMENT, TO
ARRANGE LOCAL INTERMENT IN A DIGNIFIED MATTER.

5. REQUEST AUTHORITY TO MAKE COMMITMENT TO GOG

(PARA 2 ABOVE) AS SOON AS POSSIBLE.
BURKE

3

UNCLASSIFIED

FBB230

Assoc. Dir.	
Dep. AD Adm.	
Dep. AD Inv.	
Asst. Dir.:	
Adm. Serv.	
Crim. Inv.	
Ident.	
Intell.	
Laboratory	
Legal Coun.	
Plan. & Insp.	
Rec. Mgmt.	
Tech. Servs.	
Training	
Public Affs. Off.	
Telephone Rm.	
Director's Sec'y	

PAGE 01 STATE 294824

ORIGIN ARA-15

21 Nov 78 22 53z

RECEIVED
 FEDERAL BUREAU
 OF INVESTIGATION
 COMMUNICATIONS SECTION

INFO OCT-01 SSO-00 ISO-00 SCS-06 FBIE-00 CIAE-00 PA-02

TRSE-00 MCT-02 CA-01 INR-10 INRE-00 SY-05 SYE-00

USSS-00 H-02 AID-05 SS-15 NSCE-00 CCO-00 OC-06

DUPE-00 NSAE-00 ICAE-00 SVC-00 CG-00 03 DOTE-00

[Handwritten signature]
 073 R

ALL INFORMATION CONTAINED
 HEREIN IS UNCLASSIFIED
 FEDERAL GOVERNMENT DATE 9/17/92 BY 1048DKM/jdm

DRAFTED BY ARA:CDR SANTA MARIA

APPROVED BY ARA:JABUSHNELL

[Handwritten signature: Rymur]

S/S-B:TGMARTIN

-----129596 212237Z /75

O 212016Z NOV 78

FM SECSTATE WASHDC

REC-126 89-4286-43

TO AMEMBASSY GEORGETOWN IMMEDIATE

22 NOV 24 1978

INFO JCS WASHDC IMMEDIATE 1665

SECDEF WASHDC IMMEDIATE 2054

USCINCSO QUARRY HTS IMMEDIATE

CINCMAC SCOTT AFB IL IMMEDIATE

[Handwritten signature]

UNCLAS STATE 294824

58 NOV 28 1978

E.O. 11652: N/A

TAGS: CASC, OREP (SVAN, LEO), GY

SUBJECT: EQUIPMENT FOR GUYANA NATIONAL POLICE (GDF)

REF: (A) GEORGETOWN 3785, (B) GEORGETOWN 3790,

(C) GEORGETOWN 3816

1. REFTELS, INTER ALIA, CONTAIN ITEMS OF EQUIPMENT NEEDED BY GDF FOR JONESTOWN OPERATION.

2. EQUIPMENT REQUESTED BY REF A (MINUS 54 SLEEPING BAGS) IS PRESENTLY BEING SHIPPED FROM HOWARD AFB TO GEORGETOWN.

UNCLASSIFIED

2

UNCLASSIFIED

PAGE 02

STATE 294824

EQUIPMENT IN REF C IS BEING IDENTIFIED AT PRESENT.

3. IN VIEW OF LOGISTICS PROBLEMS ASSOCIATED WITH ASSEMBLY AND TRANSPORTATION OF EQUIPMENT TO GEORGETOWN, AND THE RECOGNIZED FLUID SITUATION THERE, REQUEST CLARIFICATION OF CURRENT EQUIPMENT NEEDS IN REF B TO SUPPORT GDF. IN PARTICULAR, REQUEST ANSWERS TO FOLLOWING QUESTIONS:

(A) IS THIS REQUEST IN ALL RESPECTS ADDITIONAL TO OTHER REQUESTS? (B) WHAT ARE HIGHEST PRIORITY REQUIREMENTS?

FYI, GIVEN LOCATION OF THIS EQUIPMENT IN VARIOUS POINTS US, AND TIME REQUIRED TO CENTRALIZE IT, ITEMS MAY NOT REACH GEORGETOWN UNTIL OPERATIONS ARE VIRTUALLY COMPLETED. END

FYI. CHRISTOPHER

3

UNCLASSIFIED

FBB229

21 Nov 78 22 36z

PAGE 01 STATE 294898

ORIGIN SCS-06

RECEIVED
FEDERAL BUREAU
OF INVESTIGATION
COMMUNICATIONS SECTION

ALL INFORMATION CONTAINED
HEREIN IS UNCLASSIFIED
DATE 9/12/92 BY 1049DKM/hed

Assoc. Dir.	
Dep. AD Adm.	
Dep. AD Inv.	
Asst. Dir.:	
Adm. Serv.	
Crim. Inv.	
Ident.	
Insp.	
Intell.	
Lab.	
Legal Coun.	
Plan. & Insp.	
Rec. Mgmt.	
Tech. Serv.	
Training	
Public Affs. Off.	
Telephone Rm.	
Director's Sec'y	

INFO OCT-01 ARA-15 ISO-00 SSO-00 FBIE-00 CIAE-00

DODE-00 PA-02 TRSE-00 MCT-02 CA-01 INR-10 INRE-00

SY-05 SYE-00 USSS-00 H-02 AID-05 SS-15 NSCE-00

CCO-00 OC-06 JUSE-00 NSAE-00 ICAE-00 CG-00 L-03

DOTS-00 /073 R

Sen

WFO

FEDERAL GOVERNMENT

DRAFTED BY CA/OCS/EKIRINCICH/DG

REC-126

89-4286-44

APPROVED BY ARA/JBUSNELL

22 NOV 24 1978

SS/O THOMAS G. MARTIN

Py mur

-----129558 212229Z /75

O 212140Z NOV 78

FM SECSTATE WASHDC

TO AMEMBASSY GEORGETOWN IMMEDIATE

WFO

UNCLAS STATE 294898

58 NOV 28 1978
E.O. 11652:W/A

TAGS: CASC, CDES

SUBJECT: W/W: PEOPLES TEMPLE

1. DEPT HAS BEEN CONTACTED BY THE FAMILY OF CHRISTOPHER O'NEILL WHO HAS BEEN REPORTED AS A SURVIVOR OF JONESTOWN POST IS REQUESTED TO ADVISE, IF KNOWN, EXACT WHERE ABOUTS OF MR. O'NEILL AS FAMILY WISHES TO CONTACT HIM.

2. POST IS ALSO REQUESTED TO ADVISE WHETHER FATHER OF LIANE HARRIS HAS BEEN IN CONTACT WITH EMBASSY. DOES HE WISH DEPT TO NOTIFY NOX IN U.S. ?

3. IN ADDITION POST IS REQUESTED TO ADVISE, IF IDENTITY OF PATRICIA PARKS HAS BEEN ESTABLISHED. CHRISTOPHER

UNCLASSIFIED

2

UNCLASSIFIED

FBB231

Assoc. Dir.	
Dep. AD Adm.	
Dep. AD Inv.	
Asst. Dir.:	
Adm. Serv.	✓
Crim. Inv.	✓
Ident.	
Intell.	
Laboratory	
Legal Coun.	
Plan. & Insp.	
Rec. Mgnt.	
Tech. Servs.	
Training	
Public Affs. Off.	
Telephone Rm.	
Director's Sec'y	

PAGE 01 STATE 294823

ORIGIN ARA-15

21 Nov 78 22 54z

FEDERAL BUREAU OF INVESTIGATION COMMUNICATIONS SECTION

INFO OCT-01 ISO-00 SSO-00 NSCE-00 SS-15 SCS-06 CA-01

FBIE-00 SY-05 CIAE-00 INR-10 NSAE-00 INRE-00

CODE-00 CG-00 DOTE-00 AID-05 ICAC-00 /058 R

ALL INFORMATION CONTAINED HEREIN IS UNCLASSIFIED DATE 9/2/92 BY 1048 DKN/ldh

FEDERAL GOVERNMENT

DRAFTED BY ARA:CDR SANTA MARIA

APPROVED BY ARA:JABUSHNELL

S/S-0:TGMARTIN

Rymur

RLD

b6 per FBI
b7c

-----129575 212248Z /61

O 212016Z NOV 78

FM SECSTATE WASHDC

TO JCS WASHDC IMMEDIATE 1664

INFO AMEMBASSY GEORGETOWN IMMEDIATE

SECDEF WASHDC IMMEDIATE 2053

USCINCSO QUARRY HTS CA IMMEDIATE

CINCMAC SCOTT AFB IMMEDIATE

REC-126

89-4286-45

22 NOV 24 1978

UNCLAS STATE 294823

58 NOV 21

E.O. 11652: 10/14/78

ELX

TAGS: CASC, OREP (SMAN, LEO), GY

SUBJECT: EQUIPMENT FOR GUYANESE POLICE

REF: GEORGETOWN 3816

PARA 4 OF REFTTEL IDENTIFIES FURTHER NEEDS OF GUYANESE NATIONAL POLICE FOR FIELD INVESTIGATION AND SEARCH AND RESCUE OPERATIONS. REQUEST THAT ITEMS (CAMERAS THROUGH MESS KITS) BE PROVIDED TO THE NP FROM DOD ASSETS. CHRISTOPHER

UNCLASSIFIED

2

UNCLASSIFIED

FBB177

PAGE 01

STATE 294528

OR

IN SCS-06

21 Nov 78 07 47 *nd*

FEDERAL BUREAU OF INVESTIGATION COMMUNICATIONS SECTION

INFO OCT-01 ARA-15 ISO-00 CA-01 L-03 FBIE-00 CIAE-00
 INR-10 NSAE-00 PA-02 TRSE-00 MCT-02 DODE-00
 NSCE-00 SSO-00 ICAE-00 INRE-00 SY-05 SYE-00
 USSS-00 H-02 AID-05 SS-15 CCO-00 OC-06 JUSE-00
 SVC-00 CG-00 DOTE-00 /073 R

Assoc. Dir.	_____
Dep. AD Adm.	_____
Dep. AD Inv.	_____
Asst. Dir.:	_____
Adm. Serv.	_____
Crim. Inv.	_____
Ident.	_____
Intell.	_____
Laboratory	_____
Legal Coun.	_____
Plan. & Insp.	_____
Rec. Mgmt.	_____
Tech. Servs.	_____
Training	_____
Public Affs. Off.	_____
Telephone Rm.	_____
Director's Sec'y	_____

ALL INFORMATION CONTAINED
 HEREIN IS UNCLASSIFIED
 DATE 4/11/92 BY 1048 DKM/nda

DRAFTED BY CA/OCS:JLWARD/BGR OVE
 APPROVED BY ARA:BGR OVE
 CA:BYWATSON (PHONE)

L/CA:RHENDERSON (PHONE)
 S/S-O:JTHYDEN
 CA/OCS:AAGISE

FEDERAL GOVERNMENT

109159 210700Z /16

O 210611Z NOV 78 ZFF4
 FM SECSTATE WASHDC
 TO AMEMBASSY GEORGETOWN NIACT IMMEDIATE

O Rymur

UNCLAS STATE 294528

E.O. 11652: N/A

REC-126

89-4286-46

TAGS: CASC, GY

22 NOV 24 1978

SUBJECT: DISPOSAL OF REMAINS AT THE JONESTOWN SITE

1. THE DEPARTMENT'S CONSIDERATION OF THE PROBLEM OF
 ULTIMATE DISPOSITION OF THE REMAINS OF AMERICAN CITIZENS
 AT THE JONESTOWN SITE HAS TAKEN INTO ACCOUNT THE FOLLOWING,
 AMONG OTHER, CIRCUMSTANCES:

AS

A) MORE THAN 48 HOURS HAVE ELAPSED SINCE THE DEATHS
 OCCURRED;

B) RESOURCES NECESSARY TO IDENTIFY AND THEN TRANSPORT
 THESE REMAINS FROM JONESTOWN TO GEORGETOWN WILL NOT BE

58 NOV 29 1978

UNCLASSIFIED

UNCLASSIFIED

PAGE 02 .

STATE 294528

AVAILABLE FOR AT LEAST 12 MORE HOURS AND WILL NOT BE OPERATIONAL AT THE JONESTOWN SITE UNTIL APPROXIMATELY 96 HOURS FROM THE TIME OF THESE DEATHS;

C) HIGH TEMPERATURES AND RAIN-FALL CONDITIONS AT JONESTOWN SINCE THE TIME OF DEATHS HAVE ALREADY CAUSED SERIOUS PROBLEMS OF DECOMPOSITION;

D) THERE IS NO ADEQUATE REFRIGERATION OR RETARDANT STORAGE CAPACITY EITHER IN JONESTOWN OR GEORGETOWN TO ACCOMMODATE THE REMAINS OF MORE THAN 400 DECEASED

PERSONS; AND

E) THE IDENTIFICATION PROCESS IS BECOMING INCREASINGLY DIFFICULT BY THE HOUR, AND MAY NOT BE COMPLETED FOR AN EXTENDED PERIOD OF TIME, IN SOME INSTANCES PERHAPS NOT AT ALL.

2. THE DEPARTMENT HAS RELUCTANTLY CONCLUDED THAT THE ONLY FEASIBLE SOLUTION IS TO PROVIDE ADEQUATE AND DIGNIFIED INTERMENT OF REMAINS AT THE JONESTOWN SITE BY PROMPT BURIAL OF IDENTIFIED REMAINS, PREFERABLY AT AN ESTABLISHED GRAVE SITE IF ONE EXISTS, AND EVENTUALLY INTERMENT OF ALL DECEASED AT JONESTOWN IN SUCH A GRAVE SITE.

3. THE EMBASSY SHOULD THEREFORE ADVISE THE GOG THAT THE USG REQUESTS, IN COMPLIANCE WITH LOCAL LAW, THAT FOR HUMANE, SANITARY, AND PRACTICAL REASONS INTERMENT OF THE DECEASED AT JONESTOWN SHOULD BEGIN AT ONCE.

4. THE DEPARTMENT REQUESTS THAT EVERY EFFORT BE MADE TO PROVIDE INDIVIDUAL MARKERS AND RELOCATABLE GRAVE

UNCLASSIFIED

2

UNCLASSIFIED

PAGE 03

STATE 294528

SITES. IF IDENTIFICATION CANNOT BE ESTABLISHED, BURIAL SHOULD BE DELAYED UNTIL EVERY EFFORT AT FORENSIC IDENTIFICATION HAS BEEN MADE. THE DEPARTMENT ALSO REQUESTS THAT GUYANESE DEATH CERTIFICATES BE ISSUED IN EACH POSSIBLE CASE. IT IS OUR VIEW THAT SUCH CERTIFICATES SHOULD NOT ATTEMPT TO ESTABLISH THE CAUSES OF DEATH EXCEPT IN CASES WHERE A THOROUGH, CONCLUSIVE AUTOPSY OR CRIMINAL INVESTIGATION IDENTIFIES THE EXACT CAUSES OF DEATH, INCLUDING DISTINCTIONS BETWEEN HOMICIDE AND SUICIDE. THE EMBASSY SHOULD SUGGEST TO THE GOG THAT CAUSES OF DEATH THAT CANNOT BE DETERMINED SHOULD BE CERTIFIED AS "UNKNOWN."

5. PLEASE ADVISE IMMEDIATELY WHETHER EMBASSY PERCEIVES DIFFICULTIES IN THE FOREGOING PROCEDURES, OR HAS ADDITIONAL CONSIDERATIONS THAT SHOULD BE BROUGHT TO THE DEPARTMENT'S ATTENTION. VANCE

~~CONFIDENTIAL~~

FBS198

~~CONFIDENTIAL~~

Assoc. Dir.	
Dep. AD Adm.	
Dep. AD Inv.	
Asst. Dir.:	
Adm. Serv.	
Ident.	
Insp.	
Laboratory	
Legal Coun.	
Plan. & Insp.	
Rec. Mgmt.	
Tech. Servs.	
Training	
Public Aff's. Off.	
Telephone Rm.	
Director's Sec'y	

PAGE 01

STATE 294561

21 Nov 78 14 26z

ORIGIN ARA-15

FEDERAL BUREAU OF INVESTIGATION COMMUNICATIONS SECTION

INFO OCT-01 EUR-12 EA-10 NEA-11 ISO-00 SSO-00 DODE-00

FBIE-00 CA-01 ICAE-00 H-01 PA-01 SS-15 NSCE-00

CIAE-00 INR-10 NSAE-00 TRSE-00 SCS-06 MCT-02

INRE-00 SY-05 SYE-00 USSS-00 AID-05 CCO-00 OC-06

JUSE-00 SVC-00 CG-00 DOTE-00 L-03 /104 R

b6 per FBI
b7C

ALL INFORMATION CONTAINED
HEREIN IS UNCLASSIFIED
DATE 9/17/92 BY 1048 DKM/ndh

DRAFTED BY ARA [redacted]

FEDERAL GOVERNMENT

APPROVED BY ARA [redacted]

S/S-O [redacted]

b6 per FBI
b7C

Copy mur

-----119697 211415Z /40

0211343Z NOV 78

FM SECSTATE WASHDC

TO AMEMBASSY GEORGETOWN IMMEDIATE

AMEMBASSY PANAMA IMMEDIATE

AMEMBASSY CARACAS IMMEDIATE

AMEMBASSY PORT OF SPAIN IMMEDIATE

AMEMBASSY LONDON IMMEDIATE

AMEMBASSY PARAMARIBO IMMEDIATE

AMEMBASSY KUWAIT IMMEDIATE

AMEMBASSY ABU DHABI IMMEDIATE

AMEMBASSY BEHRAN IMMEDIATE

REC-126

89-4286-47

22 NOV 24 1978

Declass per State let 2/16/2005
UC65179DMH/ST/bpg

~~CONFIDENTIAL~~

58 NOV 21 1978

AMEMBASSY TOKYO IMMEDIATE

CINCSOUTHCOM QUARANTINE CANAL ZONE

CINCMAC SCOTT AFB ILL

US REDCOM/RCJ2 MACDILL AFB FLA

USCINCARRED FT. MCPHERSON GA

CDR 18TH AIRBORNE CORPS FT. BRAGG NC

~~CONFIDENTIAL~~ STATE 294561

LONDON FOR MICHAEL FINLEY, TOKYO FOR SENATOR HAYAKAWA

E.O. 11652: GDS

TAGS: CASC, OREP (RYAN, LEO), GY

~~CONFIDENTIAL~~

~~CONFIDENTIAL~~

2

~~CONFIDENTIAL~~

~~CONFIDENTIAL~~

PAGE 02

STATE 294561

SUBJECT: SITUATION REPORT NO. X

REFERENCE: STATE 294531 AND PREVIOUS

1. WE ARE AWAITING EMBASSY VIEWS ON OUR SUGGESTION THAT THE VICTIMS OF THE JONESTOWN TRAGEDY BE BURIED AT JONESTOWN, GIVEN THE LONG TIME OF THE BODIES IN OPEN AIR AND THE FACT THAT WE WON'T HAVE SIGNIFICANT HELICOPTER LIFT CAPACITY UNTIL WEDNESDAY. AMBASSADOR BURKE IS CURRENTLY CONSULTING WITH THE GUYANESE AUTHORITIES ON THIS SITUATION. MEANWHILE THE AIRLIFT OF HELICOPTERS AND SUPPLIES INTO GEORGETOWN BEGINS THIS MORNING WITH THE ARRIVAL OF THREE AIRCRAFT CARRYING SUPPORT EQUIPMENT AND TWO UNASSEMBLED HELICOPTERS. LOCAL BURIAL WILL NOT SIGNIFICANTLY REDUCE THE NEED FOR U.S. EQUIPMENT AND PERSONNEL NEEDED TO CARRY OUT SEARCH AND RESCUE OPERATIONS IN COOPERATION WITH GUYANESE AUTHORITIES. THREE HH-53 HELICOPTERS ARE SCHEDULED TO ARRIVE IN GEORGETOWN TOMORROW MORNING AS WELL AS FOUR ADDITIONAL LIGHT HELICOPTERS.

3
~~CONFIDENTIAL~~

2. SIX FBI AGENTS, JIM WARD (SCA) AND FRED SHAVER (ICA)

ARE SCHEDULED TO DEPART MACDILL AFB AT 11:55 TODAY.

~~CONFIDENTIAL~~

THE AGENTS WILL JOIN A LEGAL ATTACHE FROM CARACAS WHO ARRIVED YESTERDAY.

3. THE EMBASSY IS LOOKING INTO THE POSSIBILITY THAT THE OTTER DAMAGED IN THE AMBUSH AT PORT KAITUMA CAN BE REPAIRED IF PARTS WERE TO BE FLOWN IN BY OUR MILITARY TASK FORCE.

4. THE PRESS POOL WHICH VISITED JONESTOWN YESTERDAY HAS BEGUN TO FILE DETAILED STORIES. THE POOL WAS MADE UP OF CHARLES KRAUSE AND FRANK JOHNSON OF THE WASHINGTON POST, MOHAMED HAMALUDIN OF REUTERS/CANA AND A GUYANESE PHOTO-

~~CONFIDENTIAL~~

~~CONFIDENTIAL~~

PAGE 03

STATE 294561

~~CONFIDENTIAL~~

GRAPHER. VANCE

4

LIMITED OFFICIAL USE

FBB212

Assoc. Dir.	
Dep. AD Adm.	
Dep. AD Inv.	
Asst. Dir.:	
Adm. Serv.	
Crim. Inv.	<i>MS</i>
Ident.	
Insp.	
Laboratory	
Legal Coun.	
Plan. & Insp.	
Rec. Mgmt.	
Tech. Serv.	
Training	
Public Affs. Off.	
Telephone Rm.	
Director's Sec'y	

PAGE 01 STATE 294637

ORIGIN ARA-15

21 Nov 78 16 08z

RECEIVED
FEDERAL BUREAU
OF INVESTIGATION
COMMUNICATIONS SECTION

INFO OCT-01 ISO-00 AID-05 SCS-00 ~~CA-01~~ 03 FBIE-00

CIAE-00 INR-10 NSAE-00 TRSE-00 H-01 SP-02 PA-01

SSO-00 NSCE-00 INRE-00 ICAE-00 /045 R

b6 per FBI
b7C

DRAFTED BY ARA/EX: WDCALDERHEAD/CAO-GARCIA: SMALL INFORMATION CONTAINED

APPROVED BY ARA/EX: WDCALDERHEAD

HEREIN IS UNCLASSIFIED
DATE 9/17/92 BY 1048 DKN/rdm

-----122376 211559Z /53

O 211553Z NOV 78

FM SECSTATE WASHDC

FEDERAL GOVERNMENT

TO AMEMBASSY GEORGETOWN IMMEDIATE

Rymur

LIMITED OFFICIAL USE STATE 294637

REC-126

89-4286-48

FOR ADMIN. OFFICER FRANK ENGLISH FROM CALDERHEAD

NOV 24 1978

E.O. 11652: N/S

TAGS: AFSP, GY

AS

SUBJECT: PEOPLES' TEMPLE/DISPOSITION OF REMAINS

56 NOV 28 1978 GEORGETOWN 3826

1. ALL COSTS FOR U.S. PERSONNEL, INCLUDING SPECIAL
TEAMS AND MILITARY, BEING FUNDED AT THE WASHINGTON
LEVEL.

2. LOCAL LABOR COSTS AND RELATED EXPENSES CONCERNED
WITH LOCAL DISPOSITION OF REMAINS SHOULD IN FIRST
INSTANCE BE CHARGED TO POST'S PROGRAMS AND THE ALLOTMENT.

3. FUNDS FOR THIS MAY BE INCLUDED ON NEXT ALLOTMENT
ADJUSTMENT REQUEST. VANCE

LIMITED OFFICIAL USE

2

Assoc. Dir.	
Dep. AD Adm.	
Dep. AD Inv.	
Asst. Dir.:	
Adm. Serv.	<i>with</i>
Crim. Inv.	<i>with</i>
Ident.	
Intell.	
Laboratory	
Legal Coun.	
Plan. & Insp.	
Rec. Mgmt.	
Tech. Servs.	
Training	
Public Affs. Off.	
Telephone Rm.	
Director's Sec'y	

NNNNVV FBA423

OO RUEHFB

DE RUEHC #4529 3250634

ZNY CCCCC ZZH

O 210620Z NOV 78

FM SECSTATE WASHDDC

FEDERAL GOVERNMENT

TO RUEKJCS/ SECDEF WASHDC IMMEDIATE 2051

INFO RUEKJCS/ JCS WASHDC IMMEDIATE 1659

RUEHFB/FBI WASHDC IMMEDIATE

RULPALJ/USCINCSO QUARRY HTS CA IMMEDIATE

RUCINAA/CINCMAC SCOTT AFB IL IMMEDIATE

BT

~~CONFIDENTIAL~~ STATE 294529

21 NOV 78 07 42z
 RECEIVED
 FEDERAL BUREAU
 OF INVESTIGATION
 COMMUNICATIONS SECTION

b6 per FBI
 b7C

ALL INFORMATION CONTAINED
 HEREIN IS UNCLASSIFIED
 DATE 11/17/92 BY 1048 DKM/mdm

ORymur

E.O. 11652:GDS

TAGS:

SUBJECT: AIRLIFT SUPPORT REQUIREMENT

REF: JCS 210221 Z NOV. 78 (EXECUTE ORDER)

1. REQUIREMENT EXISTS FOR THE AIRLIFT OF U.S. PERSONNEL FROM ANDREWS AFB AND HOMESTEAD AFB IN SUPPORT OF GUYANA OPERATION.

2. PERSONNEL TO BE PICKED UP AT ANNDREWS AFB ARE AS FOLLOWS:

DECLASSIFIED ON 10/15/80
 BY Sp1 GJ/CIPB
 put phop call on 10/9/80
 by mgy on Pauly ToIPA
 Branch to Blair P. Hall
 State Dept.

REC-126

89-4286-49

22 NOV 24 1978

50 NOV 28 1978

A. FRED SHAVER, SSAN [REDACTED] INTERNATIONAL
COMMUNICATION AGENCY.

b6 Per Dept. of State

B. JIM WARD, SSA [REDACTED]

C.. ROBERT SEIBERT, SSAN [REDACTED] FBI, (WEAPON
S&W, MODEL 60, SN-R161636)

3. PERSONNEL TO BE PICKED UP AT HOMESTEAD AFB ARE AS
FOLLOWS:

A. BILL D. WILLIAMS, SSAN [REDACTED] FBI (WEAPON S&W,
MODEL 10-6, SN D989344)

B. JOHNNIE M.M.GIBSON, SSAN [REDACTED] FBI (WEAPON
S&W, MODEL 10-6, SN D929165

C. HERBERT L. COLLINS, JR., SSAN [REDACTED] FBI (WEAPON
S&W, MODEL 66, 357 CALIBER, FOUR INCH BARREL,
SN. 7K74110

D. RICHARD WITKOWSKY, SSAN [REDACTED] FBI (WEAPON
S&W, MODEL 15, .38 CALIBER. FOUR INCH BARREL. SN X 970
376)

E. BRENDA J. COCHRAN, SSAN [REDACTED], SECRETARY.

4. PERSONNEL WILL BE ADVISED OF PICK-UP TIME AND
FLIGHT INFORMATION BY SEPARATE MESSAGE. VANCE

BT

#4529

2

~~CONFIDENTIAL~~

FBB152

Assoc. Dir.	
Dep. AD Adm.	
Dep. AD Inv.	
Asst. Dir.:	
Adm. Serv.	<input checked="" type="checkbox"/>
Crim. Inv.	
Ident.	
Intell.	
Laboratory	
Legal Coun.	
Plan. & Insp.	
Rec. Mgmt.	
Tech. Servs.	
Training	
Public Affs. Off.	
Telephone Rm.	
Director's Sec'y	

PAGE 01 STATE 294495
ORIGIN ARA-15

21 Nov 78 4200z

INFO OCT-01 EUR-12 EA-10 NEA-11 ISO-00 SIG-03 H-01
 DODE-00 FBIE-00 PA-01 ICAE-00 SCS-05U CIAE-00
 TRSE-00 MCT-02 CA-01 IIR-10 IIR-00 SY-05 SY-00
 USSS-00 AID-05 SS-15 SSO-00 NSCE-00 CCO-00 OC-06
 JUSE-00 NSAE-00 L-03 SVC-00 /107 R

COMMUNICATIONS SECTION

ALL INFORMATION CONTAINED
HEREIN IS UNCLASSIFIED
DATE 9/17/22 BY 1048 DKM/mia

b6 per FBI
b7c

DRAFTED BY ARA [redacted]
APPROVED BY ARA [redacted]
S/S-O:T [redacted]

FEDERAL GOVERNMENT

Rymur

red

b6 per FBI
b7c

0210203Z NOV 78

FM SECSTATE WASHDC

- TO AMEMBASSY GEORGETOWN IMMEDIATE
- AMEMBASSY PANAMA IMMEDIATE
- AMEMBASSY CARACAS IMMEDIATE
- AMEMBASSY PORT OF SPAIN IMMEDIATE
- AMEMBASSY LONDON IMMEDIATE
- AMEMBASSY PARAMARIBO IMMEDIATE
- AMEMBASSY KUWAIT IMMEDIATE
- AMEMBASSY ABU DHABI IMMEDIATE
- AMEMBASSY TEHRAN IMMEDIATE
- AMEMBASSY TOKYO IMMEDIATE

REC-126

89-4286-50

22 NOV 21

Declass per State let 2/16/2005
UC 65179/DMH/ST/bpg

~~CONFIDENTIAL~~ STATE 294495

LONDON FOR MICHAEL FINLEY, TOKYO FOR SENATOR HAYAKAWA

E.O. 11652: N/A

TAGS: CASC, OREP (RYAN, LEO), GY

58 NOV 28 1978

SUBJECT: SITUATION REPORT NO. VIII

6

~~CONFIDENTIAL~~

~~CONFIDENTIAL~~

PAGE 02

STATE 294495

1. REPORTS BY GUYANESE POLICE TO U. S. EMBASSY GEORGETOWN STATE 363 BODIES OF PEOPLES TEMPLE ADHERENTS HAVE BEEN

COUNTED SO FAR AT JONESTOWN, INCLUDING BODY OF REV. JAMES JONES. EMBASSY BELIEVES SOME JONESTOWN RESIDENTS FLED INTO BUSH. THERE MAY ALSO BE ADDITIONAL DEAD NOT YET FOUND.

2. DOD COMMUNICATIONS TEAM HAS GONE TO JONESTOWN BUT COMMUNICATIONS SYSTEM NOT YET FUNCTIONING. ADVICE FROM

PATHOLOGISTS IN U. S. MAKES IT QUESTIONABLE THAT AFTER 50 HOURS BODIES AT JONESTOWN CAN BE EVACUATED AND LOCAL BURIAL MAY BE REQUIRED.

3. U. S. MILITARY NOW PLANS FLY IN THREE LARGE HELICOPTERS (HH-53), TO BE REFUELED IN AIR, PLUS FOUR SMALLER HELICOPTERS ABOARD 2 C-141S. USAF HAS NOT YET DETERMINED SUITABILITY OF MATTHEW'S RIDGE FOR C-130 USE. BY WEDNESDAY MORNING WE ANTICIPATE HAVING ABOUT 200 AMERICAN MILITARY IN GUYANA TO ASSIST IN OPERATION.

4. FBI HAS ORDERED SIX AGENTS TO STAND BY TO ASSIST IN INVESTIGATIONS IF REQUESTED BY GOG.

2

~~5~~ BODIES OF CONGRESSMAN RYAN AND THREE NEWSMEN WILL BE
FLOWN OUT TO U. S. LA. NOVEMBER 20.

6. PEOPLES TEMPLE LAWYER MARK LANE AND COLLEAGUE
CHARLES GARRY ARE IN GEORGETOWN AND GAVE PRESS CONFERENCE
NOVEMBER 20.

7. U.S. MILITARY DOES NOT POSSESS OTTER OR SIMILAR
AIRCRAFT AS REQUESTED BY GOG BUT OTHER SOLUTION BEING
EXAMINED. VANCE

~~CONFIDENTIAL~~

~~CONFIDENTIAL~~

PAGE 03

STATE 294495

PAGE 01

STATE 294822

ORIGIN CA-01

21 Nov 78 21 08z

INFO OCT-01 ARA-15 ISO-00 SSO-00 SCS-06 FBIE-00 CIAE-00
 DODE-00 PA-02 TRSE-00 MCT-02 HMUINR-10 SLANR-00 SY-05
 SYE-00 USSS-00 H-02 AID-05 SS-15 NSCE-00 CCO-00
 OC-06 JUSE-00 NSAE-00 ICAC-00 L-03 A-02 MED-05
 OPR-02 PER-05 PPT-00 /087 R

Assoc. Dir.	
Dep. AD Adm.	
Dep. AD Inv.	
Asst. Dir.:	
Adm. Serv.	
Crim. Inv.	1/25
Ident.	
Int'l.	
Laboratory	
Legal Coun.	
Plan. & Insp.	
Rec. Mgnt.	
Tech. Servs.	
Training	
Publ. Affs. Off.	
Telephone Rm.	
Director's Sec'y	

ALL INFORMATION CONTAINED
 HEREIN IS UNCLASSIFIED
 DATE 9/17/92 BY 1048 DCU

DRAFTED BY CA/OCS/EKIRINCICH/GHP
 APPROVED BY ARA/JBUSNELL
 S/S-O THOMAS G. MARTIN

Py mur

b6 per FBI
 b7C

-----127779 212058Z /75

O 212016Z NOV 78

FEDERAL GOVERNMENT

FM SECSTATE WASHDC

TO AMEMBASSY GEORGETOWN IMMEDIATE

UNCLAS STATE 294822

E.O. 11652: N/A

REC-126 89-4286-51

TAGS: CASC CDES (PEOPLES TEMPLE)

22 NOV 24 1978

SUBJECT: DEPT ASSUMPTION OF DEATH AND W/W NOTIFICATION
 RESPONSIBILITIES

REF: GEORGETOWN 3820

DEPARTMENT CONCURS WITH INFO REFTEL RE: NOTIFYING NOK OF
 BOTH DECEASED AND SURVIVING PEOPLES TEMPLE MEMBERS. ALSO
 CONCURS THE FUTURE OF

ASX

PAGE 01

STATE 294822

ORIGIN CA-01

21 Nov 78 21 06z

INFO OCT-01 ARA-15 ISO-00 SSO-00 SCS-00 FBIE-00 CIAE-00
 DODE-00 PA-02 TRSE-00 ^{FEDERAL BUREAU OF INVESTIGATION} INRE-00 SY-05
 SYE-00 USSS-00 H-02 AID-05 SS-15 NSCE-00 CCO-00
 OC-06 JUSE-00 NSAE-00 ICAE-00 L-03 A-02 MED-05
 OPR-02 PER-05 PPT-00 /087 R

FBI
 ALL INFORMATION CONTAINED
 HEREIN IS UNCLASSIFIED
 DATE 9/17/92 BY 1048 DKM/mrk

DRAFTED BY CA/OCS/EKIR INCICH/GHP
 APPROVED BY ARA/JBUSNELL
 S/S-O THOMAS G. MARTIN

-----127779 212058Z /75

O 212016Z NOV 78

FM SECSTATE WASHDC
 TO AMEMBASSY GEORGETOWN IMMEDIATE

UNCLAS STATE 294822

E.O. 11652: N/A

TAGS: CASC CDES (PEOPLES TEMPLE)

SUBJECT: DEPT ASSUMPTION OF DEATH AND W/W NOTIFICATION
 RESPONSIBILITIES

~~CARBON COPY DO NOT FILE~~

REF: GEORGETOWN 3820

DEPARTMENT CONCURS WITH INFO REFTEL RE: NOTIFYING NOK OF
 BOTH DECEASED AND SURVIVING PEOPLES TEMPLE MEMBERS. ALSO
 CONCURS THAT FUTURE CALLERS FROM U.S. SHOULD BE TOLD TO

Assoc. Dir.	
Dep. AD Adm.	
Dep. AD Inv.	
Ass. Dir.:	
Adm. Serv.	
Crim. Inv.	<i>MS</i>
Ident.	
Intell.	
Laboratory	
Legal Coun.	
Plan. & Insp.	
Rec. Mgmt.	
Tech. Serv.	
Training	
Public Affs.	
Telephone Rm.	
Director's Sec'y	

21 Nov 78 21 42 2

LIMITED OFFICIAL USE INVESTIGATION FBB226
COMMUNICATIONS SECTION

ALL INFORMATION CONTAINED
HEREIN IS UNCLASSIFIED
DATE 9/7/92 BY 1048 DEK/mk

PORT 0 03343 212119Z

PAGE 01
ACTION SCS-06
Sw

RYMUR

b6 per FBI
b7C

ms

INFO OCT-01 ARA-11 ISO-00 CA-01 H-01 SSO-00 CIAE-00

INR-10 NSAE-00 FBIE-00 JUSE-00 SYE-00 INRE-00

SY-05 /035 W

-----128431 212126Z /64

0 212018Z NOV 78

FM AMEMBASSY PORT OF SPAIN

TO SECSTATE WASHDC IMMEDIATE 3260

INFO AMEMBASSY GEORGETOWN IMMEDIATE

AMEMBASSY BRIDGETOWN

FEDERAL GOVERNMENT

REC-126 DE-15

89-4286-52

22 NOV 24 1978

DE-15

b6 per FBI
b7C

LIMITED OFFICIAL USE PORT OF SPAIN 03343

E. O. 11652: N/A

TAGS: CASC! OREP, GY

SUBJECT: PRESENCE IN PORT OF SPAIN OF MEMBERS OF PEOPLES'

TEMP 58 NOV 28 1978
11/21/78

NOV 51 2 55 PM '78

RECEIVED

NOV 51

1. ~~TWO MEMBERS OF THE GUYANA-BASED PEOPLES' TEMPLE MOVE-~~
~~MENT, CHARLES TOUCHETTE AND RICHARD JANARO (BOTH AMERICAN)~~
CAME INTO THE EMBASSY NOVEMBER 21 AFTER LEARNING EMBASSY
WAS AWARE OF THEIR PRESENCE IN PORT OF SPAIN AND WAS MAKING
QUIET INQUIRIES REGARDING THEIR WHEREABOUTS. OTHER MEMBERS
IN THE GROUP ARE MRS. HELEN SWINNEY (AMERICAN) AND PHILIP
BLAKEY (BRITISH). FOUR MEMBERS ARRIVED IN PORT OF SPAIN
NOVEMBER 5 ABOARD THE SHIP "ALBATROSS III" WHICH HAS A
CARGO FOR TRINIDAD AND BARBADOS. DECLARED PURPOSE OF VISIT
TO PORT OF SPAIN WAS TO OBTAIN SUPPLIES NEEDED FOR THE
COMMUNE. SHIP IS EXPECTED TO LEAVE HERE AT THE END OF THIS
WEEK. THE VISITORS INDICATED THAT IT IS LIKELY THAT TWO
MEMBERS WILL PROCEED WITH THE CARGO AND TWO WILL REMAIN IN
PORT OF SPAIN FOR AN AS YET UNDETERMINED PERIOD. THEY
STATED THAT THERE ARE NO OTHER MEMBERS OF THE MOVEMENT IN
TRINIDAD.

TRIN.

GUYANA

LIMITED OFFICIAL USE

2

PAGE 02

PORT O 03343 212119Z

2. WE INTEND TO INFORM THE MINISTRY OF EXTERNAL AFFAIRS AT A SENIOR LEVEL OF THE PRESENCE OF THESE FOUR IN PORT OF SPAIN, INDICATING THEY APPEAR WORRIED BUT CALM AND PEACEFUL.

3. THE MOST URGENT CONCERN OF THESE INDIVIDUALS IS THE WELFARE/WHEREABOUTS OF THEIR FAMILY MEMBERS IN GUYANA.

FAMILY MEMBERS ARE:

- JOYCE TOUCHETTE-WIFE; MICHELE TOUCHETTE, DAUGHTER, AGED 20; ALBERT TOUCHETTE, SON, AGED 22; ALL LAST KNOWN TO BE IN JONESTOWN; [REDACTED] PRESENTLY IN GEORGETOWN.

- CLAIRE JANARO, WIFE, PRESENTLY AT TOWER HOTEL IN GEORGETOWN; DAREN JANARO, SON, AGED 14, AND MAURI JANARO, DAUGHTER, AGED 15, BOTH BELIEVED TO HAVE BEEN IN JONESTOWN.

b6 Per Dept. of Stat

- [REDACTED] LAST KNOWN TO BE IN JONESTOWN.

- CLEAVE SWINNEY, HUSBAND, APPROXIMATE AGE 60; TIMOTHY SWINNEY, SON, APPROXIMATE AGE 40; BOTH BELIEVED TO HAVE BEEN IN JONESTOWN.

4. MR. JANARO AND MR. TOUCHETTE HAVE NOT REQUESTED ANY ASSISTANCE FROM THE EMBASSY OTHER THAN CURRENT INFORMATION OF THE SITUATION IN GUYANA AND INFORMATION REGARDING THEIR FAMILIES.

5. PLEASE ADVISE US ASAP IF THERE IS ANY INFORMATION WE CAN PASS ON TO THEM. POSSIBLY JOHN ADAMS, RETURNING FROM TDY IN GEORGETOWN, CAN BRING SOME DETAILS, EVEN IF PRELIMINARY. MR. JANARO AND MR. TOUCHETTE PLAN TO RETURN TO THE EMBASSY SHORTLY BEFORE NOON TOMORROW (WEDNESDAY).

LIMITED OFFICIAL USE

4

LIMITED OFFICIAL USE

PAGE 03

PORT O 03343 212119Z

FOX (DECLASSIFY UPON RECEIPT)

5

~~CONFIDENTIAL~~

22 Nov 78 13 46z

FEDERAL BUREAU OF INVESTIGATION COMMUNICATIONS SECTION

Assoc. Dir.	_____
Dep. AD Adm.	_____
Dep. AD Inv.	_____
Asst. Dir.:	_____
Adm. Serv.	_____
Crim. Inv.	_____
Ident.	_____
Intell.	_____
Laboratory	_____
Legal Coun.	_____
Plan. & Insp.	_____
Rec. Mgmt.	_____
Tech. Serv.	_____
Training	_____
Public Affs. Off.	_____
Telephone Rm.	_____
Director's Sec'y	_____

PAGE 01
ACTION ARA-15

CARACA 11013 221332Z

INFO OCT-01 ISO-00 SY-05 SYE-00 USSS-00 MCT-02 FBIE-00
 SCS-06 CA-01 JUSE-00 TRSE-00 SSO-00 NSCE-00
 INRE-00 ICAE-00 CIAE-00 DODE-00 PM-05 H-01 INR-10
 L-03 NSAE-00 NSC-05 PA-01 SP-02 SS-15 /072 W

b6 per FBI
b7c

-----011488 221337Z /53

O 221200Z NOV 78

FM AMEMBASSY CARACAS

TO SECSTATE WASHDC IMMEDIATE 4723

INFO AMEMBASSY GEORGETOWN IMMEDIATE

FEDERAL GOVERNMENT

ALL INFORMATION CONTAINED
HEREIN IS UNCLASSIFIED
DATE 9/17/92 BY 1048DKM/MDM

REC-126

~~CONFIDENTIAL~~ CARACAS 11013

89-4286-53

E.O. 11652: GDS
TAGS: CASC, OREP, GY

22 NOV 24 1978

SUBJECT: GUYANA SITUATION
Declass per State let 2/16/2005
UC65179DMH/ST/bpg

REF: STATE 294162

1. POLCOUNS BRIEFED FOR MINISTRY DIRECTOR OF
 INTERNATIONAL POLICY, AMBASSADOR PONCE, (ASSISTANT
 SECRETARY LEVEL) ABOUT THE SITUATION IN JONESTOWN
 AND ABOUT THE ACTIONS WHICH USG HAS TAKEN AND INTENDS

TO TAKE!!
58 NOV 28 1978

2. POLCOUNS GAVE MAP TO AMBASSADOR PONCE SHOWING THE
LOCATION OF JONESVILLE, POINTING OUT THAT THIS WAS
VERY CLOSE TO THE VENEZUELAN BORDER AND THAT MANY RIVERS
AND STREAMS FLOW FROM THIS AREA INTO VENEZUELA, ULTIMATELY
INTO THE ORINOCO DELTA. POLCOUNS STATED THAT SEVERAL
HUNDRED OF THE AMCIT POPULATION OF JONESVILLE HAD
FLED INTO THE JUNGLE AND WERE STILL UNACCOUNTED FOR.
HE SAID THAT IT WAS POSSIBLE THAT SOME OF THESE
PEOPLE MIGHT ENTER VENEZUELAN
TERRITORY, MOST PROBABLY

~~CONFIDENTIAL~~

~~CONFIDENTIAL~~

PAGE 02

CARACA 11013 221332Z

BY BOAT. HE ASKED AMBASSADOR PONCE TO ALERT THE APPROPRIATE VENEZUELAN AUTHORITIES TO THIS POSSIBILITY AND ASK THAT THEY INFORM THE EMBASSY IF ANY SUCH AMERICANS APPEAR.

3. PONCE SAID HE WAS GRATEFUL FOR THE BRIEFING AND SAID THAT HE WOULD IMMEDIATELY INFORM THE MINISTRIES OF INTERIOR AND DEFENSE SO THAT THEY COULD ALERT THEIR REPRESENTATIVES ALONG THE GUYANESE BORDER.

4. WE DID NOT RPT NOT ASK VENEZUELAN TO DETAIN OR ARREST ANY AMERICANS WHO WANDER ACROSS THE BORDER FROM GUYANA.

5. ACTION REQUESTED; PLEASE FURNISH FURTHER GUIDANCE CONCERNING WHAT THE EMBASSY SHOULD REQUEST THE VENEZUELAN GOVERNMENT TO DO IF ANY AMERICANS FROM JONESVILLE TURN UP IN VENEZUELAN TERRITORY.

LUERS

3

~~CONFIDENTIAL~~

F8B263

Assoc. Dir.	
Dep. AD Adm.	
Dep. AD Inv.	
Asst. Dir.:	
Adm. Serv.	<input checked="" type="checkbox"/>
Crim. Inv.	<input checked="" type="checkbox"/>
Ident.	
Intell.	
Laboratory	
Legal Coun.	
Plan. & Insp.	
Rec. Mgnt.	
Tech. Servs.	
Training	
Public Affs. Off.	
Telephone Rm.	
Director's Sec'y	

PAGE 01

GEORGE 03850 220212Z

ACTION ARA-15

FEDERAL GOVERNMENT

22 Nov 78 0318z

INFO OCT-01 ISO-00 FBIE-00 JUSE-00 CIAE-00 INR-10

FEDERAL BUREAU OF INVESTIGATION
COMMUNICATIONS SECTION

NSAE-00 CA-01 H-01 L-03 SS-15 NSCE-00 INRE-00

SSO-00 CCO-00 /046 W

[Handwritten signature]

-----001819 220220Z 173 *[Handwritten initials]*

O 220100Z NOV 78

FM AMEMBASSY GEORGETOWN

[Handwritten signature: Rymur]

ALL INFORMATION CONTAINED
HEREIN IS UNCLASSIFIED
DATE 9/12/92 BY 1048 OKM

TO SECSTATE WASHDC NIACT IMMEDIATE 8131

REC-126

89-4286-54

~~CONFIDENTIAL~~ GEORGETOWN 3850

Declass per State let 2/16/2005
UC65179DMH/ST/bpg

22 NOV 24 1978

E.O. 11652: GDS

TAGS: OASIS OREP (RYAN, LEO) GY

58 NOV 28 1978

SUBJECT: FBI PRESENCE IN GUYANA

b6 per FBI
b7C

1. MINISTER GREEN DURING HIS AFTERNOON MEETING WITH THE
AMBASSADOR, RAISED WITH HIM THE REPORT THE GUYANA GOVERNMENT HAD
RECEIVED THAT A SOUTHERN NEWSPAPER IN THE US WAS
CARRYING AN ITEM THAT THE GOG HAD REQUESTED ASSISTANCE FROM
THE FBI IN ITS EXAMINATION OF THE INCIDENT AT JONESTOWN.
MINISTER GREEN THEN PROCEEDED TO ASK AMBASSADOR IF INDEED
THERE WERE AGENTS OF THE FBI IN COUNTRY. AMBASSADOR
REPLIED THAT LEGAL ATTACHE FROM CARACAS HAD ARRIVED MORNING OF
NOVEMBER 21 AND THAT HE (AMBASSADOR) HAD CALLED COMMISSIONER OF
POLICE TO INFORM HIM OF THE LEGAL ATTACHE'S PRESENCE AND TO REQUEST
AN APPOINTMENT FOR THE LEGAL ATTACHE WITH THE POLICE
COMMISSIONER. MINISTER GREEN THEN WENT ON TO SAY THAT THE PRES-
ENCE OF FBI AGENTS IN GUYANA PRESENTS
A POLITICAL PROBLEM FOR THE GOVERNMENT. HE IMPLIED THAT
THE GOVERNMENT WAS PREPARED TO ACCEPT THE PRESENCE
OF THE LEGAL ATTACHE AS LONG AS HE WAS ALREADY IN
COUNTRY; HOWEVER, THE GOVERNMENT WOULD WANT NO MORE
AGENTS AT THIS TIME.

2. AMBASSADOR EXPECTS TO BE ABLE TO ARRANGE APPOINTMENT
WITH LEGAL ATTACHE WITH POLICE COMMISSIONER MORNING

~~CONFIDENTIAL~~

~~CONFIDENTIAL~~

PAGE 02

GEORGE 03850 220212Z

OF WEDNESDAY NOVEMBER 22. IF THIS APPOINTMENT GOES
WELL AND LIAISON ARRANGEMENT CAN BE MADE BETWEEN LEGAL
ATTACHE AND GUYANA POLICE, THERE IS ALWAYS THE POSSI-
BILITY REPEAT POSSIBILITY THAT OTHER AGENTS MAY BE
ADMITTED IF IT CAN BE PROVEN TO THE GOG THAT THEY HAD
CLEARLY SOMETHING TO GAIN FROM THE ARRANGEMENT.

BURKE

3

~~CONFIDENTIAL~~

FBB2 62

PAGE 01 GEORGE 03848 220209Z

ACTION ARA-15

22 Nov 78 03 23z

RECEIVED
FEDERAL BUREAU
OF INVESTIGATION
COMMUNICATIONS SECTION

Assoc. Dir.	
Dep. AD Adm.	
Dep. AD Inv.	
Asst. Dir.:	
Adm. Serv.	<i>[initials]</i>
Crim. Inv.	
Ident.	<i>[initials]</i>
Intel.	
Laboratory	
Legal Coun.	
Plan. & Insp.	
Rec. Mgmt.	
Tech. Servs.	
Training	
Public Affs. Off.	
Telephone Rm.	
Director's Sec'y	

INFO OCT-01 ISO-00 SSO-00 FBIE-00 CIAE-00 ON PA-01 SCS-06

MCT-02 CA-01 INR-10 INRE-00 SY-05 SYE-00 USSS-00

H-01 AID-05 SS-15 NSCE-00 CCO-00 OC-06 JUSE-00

NSAE-00 ICAE-00 CG-00 L-03 DOTE-00 AS-02 PM-05

[Handwritten signature]

/078 W

FBI
ALL INFORMATION CONTAINED
HEREIN IS UNCLASSIFIED
DATE *[initials]* BY *[initials]* 201779 220218Z 175

[Redacted box]

b6 per FBI
b7C

O 220045Z NOV 78 ZFF-6

FEDERAL GOVERNMENT

[Handwritten initials]

FM AMEMBASSY GEORGETOWN
TO USCINCSO QUARRY HEIGHTS CZ IMMEDIATE

USCINCRD MAC DILL AFB FLA IMMEDIATE

CINCMAC SCOTT AFB ILL IMMEDIATE

JSC WASHDC IMMEDIATE

CSAF WASHDC IMMEDIATE

REC-126

INFO SECDEF WASHDC IMMEDIATE

SECSTATE WASHDC IMMEDIATE 3848

WHITE HOUSE WASHDC/SITROOM IMMEDIATE

DIRNSA FT GEORGE G MEADE MD IMMEDIATE

21 AF OC MCGUIRE AFB NJ IMMEDIATE

AF MPC RANDOLPH AFB TX/MPCCM IMMEDIATE

USCINCARRED FT MCPHERSON GA IMMEDIATE

436 MAW DOVER AFB DE/SVM/ IMMEDIATE

436 ABQ DOVER AFB DE/SVM/ IMMEDIATE

[Large handwritten signature]

89-4286-55

22 NOV 24 1978

58 NOV 28 1978

~~CONFIDENTIAL~~ GEORGETOWN 3848

COMUSJTF SOUTH (GUYANA OPERATION) SENDS

REF: A. JCS 210221Z NOV 78

1. (U) SITUATION, INITIAL ELEMENTS OF USJTF SOUTH ARRIVED TIMEHRI AIRPORT, GUYANA AT 211130Z NOV 78, AND WERE MET BY REPRESENTATIVES OF THE GUYANA DEFENSE FORCE (GDF) AND AMEMB GEORGETOWN, GUYANA. REMAINDER OF USSOUTHCOM ELEMENTS HAVE ARRIVED AND THE SUPPORT BASE AT TIMEHRI AIRPORT HAS BEEN ESTABLISHED, FACILITATED BY REPRESENTATIVES OF AMEMBASSY

~~CONFIDENTIAL~~

~~CONFIDENTIAL~~

PAGE 02

GEORGE 03848 220209Z

GEORGETOWN.

2. ~~(C)~~ INTELLIGENCE. CURRENT SITUATION IN JONESTOWN

IS STABLE. GDF TOOK CONTROL OF JONESTOWN EVENING OF 19 NOV WITH NO OPPOSITION. GDF HAS CONFIRMED 405 DEAD, INCLUDING JAMES JONES, OF VOLUNTARILY INGESTED POTASSIUM CYANIDE LACED KOOL-AID.

JONES HAD ALSO BEEN SHOT AS HAD A VERY FEW OF THE 405 DEAD.

IT IS PROBABLY THAT ALL OR MOST OF JONES' HARD CORE FOLLOWERS ARE DEAD, THUS REDUCING THE POTENTIAL THREAT TO

USJTF RECOVERY OPERATIONS. RETURNING

SURVIVORS THUS FAR HAVE NOT BEEN HOSTILE. SOME WEAPONS,

HOWEVER, ARE BELIEVED UNACCOUNTED FOR; AS A RESULT, THE THREAT OF RANDOM SNIPER ATTACKS CANNOT BE DISCOUNTED. UTM COORDINATES

OF JONESTOWN ARE ESTIMATED AS 21NSJ762492. THESE COORDINATES

WILL BE UPDATED WHEN LOCATION VERIFIED. WEATHER IN JONESTOWN

ARE IS HOT AND HUMID, WITH A HIGH INCIDENCE OF TROPICAL RAIN

SHOWERS; THUS HAMPERING RECOVERY OPERATIONS.

5954

b6 per FBI
b7c

3

3. ~~CONFIDENTIAL~~ EVALUATION OF SIGNIFICANT FACTORS.

A. GDF REPRESENTATIVES HAVE BEEN MOST CORDIAL AND HELPFUL.

THEIR COOPERATION AND ASSISTANCE HAVE ALREADY PROVEN INVALUABLE AND SHOULD FACILITATE RECOVERY OPERATIONS.

B. HF VOICE NET HAS BEEN ESTABLISHED BY USAF CCT PERSONNEL.

USA COMMUNICATIONS ARE BEING ESTABLISHED AT THIS TIME.

C. NO SIGNIFICANT LOGISTICS PROBLEMS ARE FORESEEN UNLESS

DELAYS ARE ENCOUNTERED IN THE ARRIVAL OF CONOS AUGMENTATION

PERSONNEL AND EQUIPMENT SCHEDULED IN TONIGHT AND EARLY TOMORROW.

D. PERSONNEL OF USJTF SOUTH PRESENTLY TOTALS 17 OFFICERS

AND 58 ENLISTED.

4. (U) OPERATIONS SUMMARY. THE COMMANDER USJTF MET WITH

THE AMERICAN AMBASSADOR TODAY TO DISCUSS THE RECOVERY OPERATION.

ONE USJTF MEMBER OVERFLEW THE OPERATIONAL AREA ABOARD A LOCAL

~~CONFIDENTIAL~~

4

~~CONFIDENTIAL~~

PAGE 03

GEORGE 03848 220209Z

CESSNA AND ASSESSED THE AIRFIELDS AT MATTHEWS RIDGE AND PORT KAITUMA. HE ALSO OVERFLEW JONESTOWN. REMAINDER OF DAY HAS BEEN UTILIZED IN CONDUCTING THE ORGANIZATION PLANNING AND COORDINATION REQUIRED TO COMMENCE RECOVERY OPERATIONS IN THE MORNING.

5. ~~COX~~ COMMANDERS PLANS. AT 220430Z NOV 78 MOVEMENT TO THE FORWARD AREA WILL BEGIN. UTILIZING ORGANIC FIXED WING AND GDF FIXED AND ROTARY WING ASSETS, A REFUE POINT WILL BE ESTABLISHED AT MATTHEWS RIDGE AIRFIELD AND A FORWARD BASE WILL BE ESTABLISHED AT JONESTOWN. PRIORITY OF TASKS WILL BE ESTABLISHMENT OF REFUE POINT, MOVEMENT OF GRAVES REGISTRATION/ BODY RECOVERY ELEMENT TO JONESTOWN, INITIATION OF BODY I.D./ PREPARATION FOR MOVEMENT, ESTABLISHMENT OF FORWARD CP AT JONESTOWN. CH53 ASSETS WILL BE EMPLOYED AS SOON AS AVAILABLE FOR TRANSHIPMENT OF BODIES FROM JONESTOWN TO GEORGETOWN.

BURKE

5

22 Nov 78 12 52z

FEDERAL BUREAU OF INVESTIGATION COMMUNICATIONS SECTION

Assoc. Dir.	
Dep. AD Adm.	
Dep. AD Inv.	
Asst. Dir.:	
Adm. Serv.	
Crim. Inv.	
Ident.	
Intell.	
Laboratory	
Legal Coun.	
Plan. & Insp.	
Rec. Mgnt.	
Tech. Servs.	
Training	
Public Affs. Off.	
Telephone Rm.	
Director's Sec'y	

Sub

UNCLASSIFIED FBB302

PAGE 01 GEORGE 03818 221113Z

ACTION SCS-06

b6 per FBI
b7C

FEDERAL GOVERNMENT

ORymur

rls

INFO OCT-01S ARA-15 ISO-00 H-02 SS-15 NSC-05 CIAE-00

INR-10 NSAE-00 DODE-00 PA-02 FBIE-00 CA-01 MCT-02

SY-05 PPTC-00 /064 W

-----008743 221243Z /23/23

R 202300Z NOV 78

FM AMEMBASSY GEORGETOWN

TO SECSTATE WASHDC 8107

ALL INFORMATION CONTAINED
HEREIN IS UNCLASSIFIED
DATE 2/17/92 BY 1048 DKM/udm

89-4286-56

REC-126

22 NOV 24 1978

UNCLAS GEORGETOWN 3818

CORRECTED COPY (EO, TAGS, SUBJECT)

E.O. 11652: N/A

TAGS: CDES GY (AMOS, LINDA SHARON (HARRIS, LIANE)

MURDER/SUICIDE AT PEOPLES TEMPLE GEORGETOWN RESIDENCE

58 NOV 28 1978

A. UNCLAS STATE 293789 B. GEORGETOWN 3789

[Handwritten signature]

A. EMBASSY HAS FURTHER INFORMATION ON SUBJECTS.

"SHARON AMOS" WAS BORN LINDA SHARON SILVERSTEIN. SHE WAS AT ONE TIME MARRIED TO SHERWIN HARRIS FROM WHO SHE IS NOW DIVORCED AND SUBSEQUENTLY BEGAN USING THE SURNAME AMOS. IT IS POSSIBLE THAT SHE WAS NOT LEGALLY MARRIED TO MR AMOS. SHE WAS APPROXIMATELY 40 YEARS OLD AND ABOUT 4'10" TALL. BEFORE COMING TO THE JONESTOWN PROJECT SHE RESIDED IN CALIFORNIA.

B. LIANE HARRIS WAS REPORTEDLY BORN NOVEMBER 26, 1956 IN SAN FRANCISCO. NO OTHER NAMES ARE KNOWN TO HAVE BEEN USED.

C. MR HARRIS INFORMS US THAT THE TWO YOUNGER CHILDREN WERE NAMED CHRISTA AND MARTIN AMOS. HE BELIEVES THAT CHRISTA WAS 11 YEARS OLD AND MARTIN WAS 10. HE ATTRIBUTED OUR UNDERESTIMATION IN REF B TO THEIR SLIGHT STATURE.

BURKE

UNCLASSIFIED

UNCLASSIFIED

Assoc. Dir.	_____
Dep. AD Adm.	_____
Dep. AD Inv.	_____
Asst. Dir.:	_____
Adm. Serv.	_____
Crim. Inv.	_____
Ident.	_____
Intell.	_____
Laboratory	_____
Legal Coun.	_____
Plan. & Insp.	_____
Rec. Mgnt.	_____
Tech. Servs.	_____
Training	_____
Public Affs. Off.	_____
Telephone Rm.	_____
Director's Sec'y	_____

PAGE 01 GEORGE 03818 210322Z

ACTION SCS-06

22 Nov 78 07 09 *nd*

INFO OCT-01 ARA-15 ISO-00 H-02 OF ISS-15 ACTION SC-05 CIAE-00

INR-10 NSAE-00 DODE-00 PA-02 FBIE-00 CA-01 MCI-02

SY-05 SVC-00 PPTE-00 /064 W

See

RECEIVED
FEDERAL BUREAU
OF INVESTIGATION
COMMUNICATIONS SECTION

b6 per FBI
b7C

ALL INFORMATION CONTAINED
HEREIN IS UNCLASSIFIED
DATE 9/17/92 BY 1048 DKN/nd

R 202300Z NOV 78

FM AMEMBASSY GEORGETOWN

FEDERAL GOVERNMENT

TO SECSTATE WASHDC 8107

Rymur

UNCLAS GEORGETOWN 3818

REF: A) STATE 293789 B) GEORGETOWN 3789

REC-126

89-4286-57

A. EMBASSY HAS FURTHER INFORMATION ON SUBJECTS.

"SHARON AMOS" WAS BORN LINDA SHARON SILVERSTEIN. SHE WAS
 AT ONE TIME MARRIED TO SHERWIN HARRIS FROM WHOM SHE IS NOW
 DIVORCED AND SUBSEQUENTLY BEGAN USING THE SURNAME AMOS. IT
 IS POSSIBLE THAT SHE WAS NOT LEGALLY MARRIED TO MR AMOS.
 SHE WAS APPROXIMATELY 40 YEARS OLD AND ABOUT 4'10" TALL.
 BEFORE COMING TO THE JONESTOWN PROJECT SHE RESIDED IN
 CALIFORNIA.

22 NOV 24 1978

AS

B. LIANE HARRIS WAS REPORTEDLY BORN NOVEMBER 26, 1956 IN SAN FRANCISCO

0, 58 NOV 29 1978

NO OTHER NAMES ARE KNOWN TO HAVE BEEN USED.

C. McHARRIS INFORMS US THAT THE TWO YOUNGER CHILDREN WERE NAMED
CHRISTA AND MARTIN AGOS. HE BELIEVES THAT CHRISTA WAS 11 YEARS
OLD AND MARTIN WAS 10. HE ATTRIBUTED OUR UNDER ESTIMATION
IN REF B TO THEIR SLIGHT STATURE.

BURKE

NOTE BY OC/T: OMISSION - E.O., TAGS, SUBJ & REF(S) - CORRECTION
TO FOLLOW

UNCLASSIFIED

2

~~CONFIDENTIAL~~

FBB266

Assoc. Dir.	
Dep. AD Adm.	
Dep. AD Inv.	
Asst. Dir.:	
Adm. Serv.	<input checked="" type="checkbox"/>
Crim. Inv.	<input checked="" type="checkbox"/>
Ident.	<input checked="" type="checkbox"/>
Intell.	
Laboratory	
Legal Coun.	
Plan. & Insp.	
Rec. Mgnt.	
Tech. Servs.	
Training	
Public Affs. Off.	
Telephone Rm.	
Director's Sec'y	

PAGE 01

GEORGE 03847 ^{22 NOV 78} 220234Z 03 24Z

ACTION ARA-15

RECEIVED
FEDERAL BUREAU
OF INVESTIGATION
COMMUNICATIONS SECTION

INFO OCT-01 ISO-00 FBIE-00 CIAE-00 DODE-00 PA-01

TRSE-00 SCS-06 MCT-02 CA-01 INR-10 INRE-00 SY-05

SYE-00 USSS-00 H-01 AID-05 SS-15 SSO-00 NSCE-00

CCO-00 OC-06 JUSE-00 NSAE-00 ICAE-00 AS-02 CG-00

L-03 DOTE-00 /073 W

[Handwritten signature]

222078 220244Z 175

ALL INFORMATION CONTAINED

HEREIN IS UNCLASSIFIED

DATE 9/17/92 BY 1048 DCM/ndb

FEDERAL GOVERNMENT

b6 per FBI
b7C

0 212200Z NOV 78

FM AMEMBASSY GEORGETOWN

TO SECSTATE WASHDC NIACT IMMEDIATE 8128

[Handwritten signature: Pymur]

89-4286-58

~~CONFIDENTIAL~~ GEORGETOWN 3847

REC-126

E.O. 11652: GDS

22 NOV 24 1978

TAGS: CASC (PEOPLE'S TEMPLE)

SUBJECT: SURVIVORS OF PEOPLE'S TEMPLE GROUP

58 NOV 29 1978

REF: GEORGETOWN 3821

Declass per State let 2/16/2005
UC65179DMH/ST/bpg

[Handwritten signature]
[Handwritten signature]

1. DISCUSSION WITH POLICE REVEALS THAT THEY PREFER TO KEEP ALL PERSONS CONNECTED WITH THE PEOPLE'S TEMPLE ORGANIZATION AVAILABLE IN THE COUNTRY FOR "TWO OR THREE DAYS". THE INDIVIDUALS LISTED IN REF MSG ARE STAYING AT EVE LEARY, THE POLICE HEADQUARTERS, IN WHAT MAY BE TERMED PROTECTIVE CUSTODY. THEY ARE FREE TO GO TO A HOTEL IF THEY WISH. THE POLICE, HOWEVER, CANNOT GUARANTEE THEIR SECURITY AT A HOTEL BECAUSE RESOURCES ARE ALREADY STRETCHED THIN, AND IT IS UNLIKELY THAT THEY WILL CONSIDER MOVING WITHOUT ASSURANCE OF SECURITY. THEY ARE STILL FEARFUL OF RETALIATORY MEASURES FROM UNKNOWN MEMBERS OF THE PEOPLE'S TEMPLE, EITHER HERE OR FROM THE UNITED STATES. THEY STILL SEEM CONTENT TO REMAIN WHERE THEY ARE AND ARE NOT RPT NOT PRESSING FOR REPATRIATION.

2. A GROUP OF PEOPLE'S TEMPLE INDIVIDUALS ARE STAYING IN THE GEORGETOWN HQS BUILDING, LAMAHA GARDENS, AND ARE NOT RPT NOT FREE TO MOVE ELSEWHERE IF THEY WISH. THEY DID DO SOME

~~CONFIDENTIAL~~

2

~~CONFIDENTIAL~~

PAGE 02

GEORGE 03847 220234Z

SHOPPING FOR ESSENTIALS THIS MORNING BUT WERE ESCORTED AT ALL TIMES. THE NAMES OF THOSE AT LAMAHA GARDENS ARE LISTED BELOW. THE EVE LEARY GROUP HAS EXPRESSED A STRONG DESIRE TO BE KEPT ISOLATED FROM THE LAMAHA GARDENS GROUP.

3. THERE ARE THREE PEOPLE IN THE PUBLIC HOSPITAL, ONE IS MONICA BAGLEY, WHO WAS INJURED AT PORT KAITUMA INCIDENT WHEN CONGRESSMAN RYAN WAS KILLED. SHE WAS OPERATED ON A SECOND TIME YESTERDAY (MONDAY) BECAUSE OF HEMOTHORAX (BLOOD SEEPING INTO THE PLEURAL CAVITY) ON THE LEFT SIDE. HER LUNG COLLAPSED, BUT THE CAVITY IS BEING PUMPED FREE OF BLOOD. THE DOCTOR SAYS HER CONDITION IS STABLE, AND DAILY X-RAYS WILL BE TAKEN TO ENSURE THE LUNG IS CLEARING. IN THE DOCTOR'S ESTIMATION, SHE SHOULD NOT BE EVACUATED UNTIL THE WEEKEND, BUT SAID THAT ESTIMATE COULD BE REVISED IN 48 HOURS. SHE HAS SPECIFICALLY REQUESTED THAT SHE NOT RPT NOT BE MOVED, APPARENTLY BECAUSE OF THE THE SAME FEAR CURRENTLY MOTIVATING GROUP AT EVE LEARY. DEPARTMENT MAY, HOWEVER, WISH TO CONSIDER THE ADVISABILITY OF A MED-EVAC FOR HER SINCE CONDITIONS AT PUBLIC HOSPITAL ARE NOT RPT NOT THE BEST.

3

4. MISS BAGLEY SAYS THAT HER MOTHER, [REDACTED]
HAS BEEN INFORMED OF HER WHEREABOUTS AND CONDITION, BUT
DID NOT SAY HOW THE INFORMATION WAS PASSED. HER MOTHER'S

ADDRESS IS [REDACTED]

[REDACTED] SHE GAVE VERBAL PERMISSION ONLY

FOR RELEASE OF INFORMATION TO [REDACTED]

[REDACTED] b6 Per Dept. of State.

5. [REDACTED] WHO

IS AT EVE LEARY, HAVE MINOR WOUNDS AND APPEAR WELL. THEY

WERE INJURED IN [REDACTED] AND WERE DISCOVERED

YESTERDAY. THEY HAD REMAINED HIDDEN WHILE OTHER INJURED WERE

~~CONFIDENTIAL~~

4

~~CONFIDENTIAL~~

PAGE 03

GEORGE 03847 220234Z

EVACUATED.

b6 Per Dept. of State

6. THERE ARE POLICE OFFICERS STATIONED AT THE ENTRANCE TO THE HOSPITAL AND INFRONT OF ROOMS OCCUPIED BY [REDACTED] AND MS BAGLEY. AS OF THIS TIME, ACCESS TO THEM WILL BE PERMITTED ONLY IF THE CONSULAR OFFICER IS ACCOMPANIED BY A MEMBER OF POLICE HEADQUARTERS.

7. LARRY LAYTON, THE PERSON NAMED AS THE INDIVIDUAL WHO STARTED THE SHOOTING AT PORT KAITUMA, WAS BROUGHT TO GEORGETOWN TODAY FROM PORT KAITUMA AND WAS IN THE CUSTODY OF POLICE, IN HANDCUFFS. TO BEST OF OUR KNOWLEDGE HE HAS NOT RPT NOT BEEN CHARGED, BUT IS OBVIOUSLY BEING TREATED AS A SUSPECT. TWO OTHER PEOPLE, IDENTIFIED ONLY AS TWO BROTHERS NAMED CARTER, ARE ALSO REPORTEDLY BEING HELD CLOSELY BY POLICE.

8. THE POLICE HAVE BEEN ASKED TO NOTIFY LAYTON AND THE CARTERS AND PEOPLE DETAINED AT LAMAHA GARDENS THAT THEY HAVE THE RIGHT TO SPEAK TO A CONSULAR OFFICER AND HAVE PROMISED TO NOTIFY US IF THEY REQUEST OUR PRESENCE.

9. FURTHER INFORMATION ON THE SURVIVING MEMBERS OF THE PEOPLE'S TEMPLE WILL BE FORWARDED AS AVAILABLE.

5

1.



2.

3.

b6 Per Dept. of State

4. PAULA ADAMS

5.



6.

7. JOAN PURSLAY

8. CHARLES EDWARD BEIKMAN CALLED CHUCK BEIKMAN

9. VEDRA YATES

10. BEATRICE ORSAT

11. MICHAEL TOUCHETTE

12.



CONFIDENTIAL

6

~~CONFIDENTIAL~~

PAGE 04

GEORGE 03847 220234Z

13. JAMES JONES

14.

15. DIANNE E. SCHEID AKA CASANOVA

16.

17.

18.

19.

b6 Per Dept. of State

20. LAURA JOHNSTON

21. THOMAS BEIXMAN

22. TIMOTHY JONES

23.

24. CAROL YOUNG

25.

26.

27.

28.

29.

30. PAUL MCCANN

31. EUGENE SMITH

7

32. [REDACTED]

33. BOBBY STROUD

34. [REDACTED]

35. [REDACTED]

36. [REDACTED]

b6 Per Dept. of State

37. AURORA RODRIGUEZ

38. DAUN MITCHELLE

49. RUBY JOHNSON

40. GUY MITCHELL

41. LAVARY LAFFERWHITE

42. MADELANE BROOKS

43. STEPHAN JONES

44. RAYMOND GODSHALF

BURKE

~~CONFIDENTIAL~~

~~CONFIDENTIAL~~

8

~~CONFIDENTIAL~~

FBB267

Assoc. Dir.	
Dep. AD Adm.	
Dep. AD Inv.	
Asst. Dir.:	
Adm. Serv.	
Crim. Inv.	
Ident.	
Intell.	
Laboratory	
Legal Coun.	
Plan. & Insp.	
Rec. Mgnt.	
Tech. Servs.	
Training	
Public Affs. Off.	
Telephone Rm.	
Director's Sec'y	

PAGE 01 STATE 294872

ORIGIN ARA-15

22 Nov 78 0338z

INFO OCT-01 ISO-00 FBIE-00 SCSE-00 SC-00-00-00 INR-10
 NSAE-00 PA-01 TRSE-00 MCI-02 CA-01 SY-05 SYE-00
 USSS-00 H-01 AID-05 SS-15 L-03 JUSE-00 CG-00
 DOTE-00 OC-06 CCO-00 DODE-00 NSCE-00 SSO-00
 ICAE-00 INRE-00 AS-02 /073 R

RECEIVED
 OF INVESTIGATION
 COMMUNICATIONS SECTION

[Handwritten signature]

FEDERAL GOVERNMENT

ALL INFORMATION CONTAINED
 HEREIN IS UNCLASSIFIED
 DATE 9/12/92 BY 1048 DKA/ida

DRAFTED BY ARA/GWG [Redacted]

APPROVED BY ARA:GWG [Redacted]

FBI: MR. NICHOLAS (DRAFT)

[Handwritten signature: Kymur]

[Handwritten initials]

b6 per FBI
b7C

S/S-0 [Redacted]

-----002071 220245Z /73

O 212105Z NOV 78

FM SECSTATE WASHDC

TO AMEMBASSY CARACAS IMMEDIATE

REC-126

AMEMBASSY PARAMARIBO IMMEDIATE

AMEMBASSY PORT OF SPAIN IMMEDIATE

AMEMBASSY BRIDGETOWN IMMEDIATE

INFO CINCSOUTHCOM QUARRY HTS CZ IMMEDIATE

CINCMAC SCOTT AFB ILL IMMEDIATE

USREDCOM/RCJ2 MACDILL AFB FLA IMMEDIATE

USCINCARRED FT MCPHERSON GA IMMEDIATE

Declass per State let 2/16/2005

✓ CDR 18TH AIRBORNE CORPS FT BRAGG NC IMMEDIATE

UC65179DMH/ST/bpg

USCINCEUR VAIHINGEN GE/J-2 IMMEDIATE

AMEMBASSY GEORGETOWN IMMEDIATE

58 NOV 28 1978

[Handwritten: 89-4286-59]
 22 NOV 24 1978

[Handwritten signature]

~~CONFIDENTIAL~~ STATE 294872

E.O. 11652:GDS

TAGS: CASC, OREP, GY

SUBJECT: GUYANA SITUATION

REF: STATE 294162

1. AS POSTS NOW AWARE, REV. JIM JONES DIED WITH MANY OF HIS FOLLOWERS AT JONESTOWN. HOWEVER, POSSIBILITY STILL

~~CONFIDENTIAL~~

2

~~CONFIDENTIAL~~

PAGE 02

STATE 294872

EXISTS THAT OTHER PT MEMBERS WHO FLED FROM JONESTOWN
MAY ATTEMPT TO LEAVE GUYANA BY SEA FOR NEIGHBORING COUNTRIES.
PLEASE KEEP IN TOUCH WITH LOCAL AUTHORITIES, AND REPORT
ANY INSTANCES OF THIS WHICH MAY COME TO THEIR ATTENTION.

2. INVESTIGATION AS TO POSSIBLE VIOLATIONS OF US LAW IN
THIS CASE CONTINUES. TO DATE WE HAVE NO FURTHER INFORMATION
CONCERNING POSSIBLE ISSUANCE OF ARREST WARRANTS BY GOG.

CHRISTOPHER

3

~~CONFIDENTIAL~~

FBB291

Assoc. Dir.	
Dep. AD Adm.	
Dep. AD Inv.	
Asst. Dir.:	
Adm. Serv.	<i>W</i>
Crim. Inv.	<i>W</i>
Ident.	
Intell.	
Laboratory	
Legal Coun.	
Plan. & Insp.	
Rec. Mgnt.	
Tech. Servs.	
Training	
Public Affs. Off.	
Telephone Rm.	
Director's Sec'y	

PAGE 01 STATE 295 682 TOSEC 130007

ORIGIN ARA-15

22 Nov 78 10 44z *nd*

FEDERAL BUREAU OF INVESTIGATION COMMUNICATIONS SECTION

INFO OCT-01 EUR-12 NEA-11 ISO-00 H-01 SS-15 SY-05

INR-10 CA-01 AS-02 MCT-02 SCS-06 PA-01 AID-05

OC-06 L-03 SYE-00 CCO-00 SSO-00 NSCE-00 USSS-00

INRE-00 TRSE-00 DODE-00 CIAE-00 FBIE-00 JUSE-00

NSAE-00 CG-00 DOTE-00 SIG-03 /099 R

FBI
ALL INFORMATION CONTAINED
HEREIN IS UNCLASSIFIED
DATE *9/17/92* BY *108 DCM/nd*

DRAFTED BY ARA/GWG: [redacted]

FEDERAL GOVERNMENT

APPROVED BY ARA [redacted]

Rymur *nd*

S/S-0: [redacted] b6 per FBI b7C

-----007516 221015Z /21

B 220837Z NOV 78/ZFF4

Declass per State let 2/16/2005 UC65179DMH/ST/bpg

FM SECSTATE WASHDC

TO AMEMBASSY GEORGETOWN IMMEDIATE

USDEL SECRETARY IMMEDIATE DE-15

AMEMBASSY PANAMA IMMEDIATE REC-126

AMEMBASSY CARACAS IMMEDIATE

AMEMBASSY PORT OF SPAIN IMMEDIATE

AMEMBASSY LONDON IMMEDIATE

AMEMBASSY PARAMARIBO IMMEDIATE

AMEMBASSY KUWAIT IMMEDIATE

CINCSOUTHCOM QUARRY HTS CA IMMEDIATE

CINCMAC SCOTT AFB ILL IMMEDIATE

✓ US REDCOM/RCJ2 MACDILL AFS FLA IMMEDIATE

USCINCARRED FT MCPHERSON GA IMMEDIATE

CDR 18TH AIRBORNE CORPS FT BRAGG NC IMMEDIATE

USCINCEUR VAIHINGEN GE ATTEN: J-2 IMMEDIATE

3 NOV 78 1978

89-4286-60

[redacted] 22 NOV 24 1978

b6 per FBI b7C

(Classified)
Revised

~~CONFIDENTIAL~~ STATE 295682 TOSEC 130007

LONDON FOR MICHAEL FINLEY, TOKYO FOR SENATOR HAYAKAWA

E.O. 11652: GDS

TAGS: CASC, OREP, (RYAN, LEO), GY

~~CONFIDENTIAL~~

~~CONFIDENTIAL~~

PAGE 02

STATE 295682 TOSEC 130007

SUBJECT: SITUATION REPORT NO. 12

REF: STATE 295259 AND PREVIOUS

2

ON INFORMATION RECEIVED FROM THE GUYANESE AUTHORITY,
THE EMBASSY GEORGETOWN HAS TRANSMITTED THE NAMES OF 174
WHO WERE DECEASED. THE SCA TEAM HAS BEGUN NOTIFYING THE NEXT
OF KIN. APPARENTLY, SOME ELEMENTS OF THE PRESS HAVE RE-
CEIVED THE SAME LIST. HOWEVER, THE DEPARTMENT WILL NOT BE
RELEASING THE NAMES TO THE MEDIA.

2. VERY FEW SURVIVORS HAVE BEEN LOCATED IN THE JONESTOWN
AREA THUS FAR, PERHAPS NO MORE THAN 20. COUNTING THESE,
CLOSE TO 70 PEOPLE'S TEMPLE MEMBERS ARE NOW IN GEORGETOWN.
SOME OF THESE WERE NOT IN JONESTOWN ON SATURDAY. U.S. MILI-
TARY AUTHORITIES BELIEVE THEY HAVE SUFFICIENT FACILITIES
AND PERSONNEL IN GEORGETOWN IN THE EVENT OF ANY INFLUX OF
SURVIVORS.

3. ~~LARRY LAYTON~~, THE PERSON NAMED AS THE ONE WHO STARTED
THE SHOOTING, IS IN GEORGETOWN IN CUSTODY OF THE POLICE.
TO THE EMBASSY'S KNOWLEDGE, HE HAS NOT BEEN CHARGED, BUT IS
OBVIOUSLY BEING TREATED AS A SUSPECT. THE PEOPLE'S TEMPLE

US
Guyana

MEMBERS IN GEORGETOWN APPEAR TO BE DIVIDED INTO TWO GROUPS,
ONE GROUP STAYING AT THE GEORGETOWN POLICE HEADQUARTERS
AND THE OTHER ELSEWHERE IN TOWN. THREE ARE STILL IN THE
HOSPITAL. POLICE OFFICIALS HAVE INFORMED THE EMBASSY THAT
THEY PREFER TO KEEP ALL PERSONS CONNECTED WITH THE PEOPLE'S
TEMPLE ORGANIZATION AVAILABLE IN THE COUNTRY FOR "TWO OR
THREE DAYS".

4. USAF PLANES CONTINUE TO ARRIVE IN GEORGETOWN BEARING

CONFIDENTIAL

3

EQUIPMENT, SUPPLIES AND SUPPORT PERSONNEL. THE U.S. MILITARY COMMANDER THERE REPORTS THAT THE GUYANESE DEFENSE FORCE REPRESENTATIVES HAVE BEEN MOST CORDIAL AND HELPFUL. BECAUSE OF SPACE LIMITATIONS AT THE GEORGETOWN AIRPORT, TURNAROUND TIME IS BEING HELD TO THE MINIMUM. THE AIRCRAFT CARRYING THE GRAVES IDENTIFICATION UNIT AND EQUIPMENT HAS BEEN DELAYED BECAUSE OF MECHANICAL PROBLEMS AND NOW WILL NOT BE ARRIVING IN GEORGETOWN UNTIL 0430 GEORGETOWN TIME. WE HAVE FORMALLY REQUESTED DOD TO PROVIDE TRANSPORTATION TO THE UNITED STATES FOR PEOPLE'S TEMPLE SURVIVORS WHO DESIRE TO LEAVE GUYANA.

5. AID IS CONTINUING TO INVESTIGATE THE POSSIBILITY OF ASSISTING THE GUYANESE GOVERNMENT TO REPLACE, ON A TEMPORARY LEASE BASIS, THE TWIN OTTER DAMAGED DURING THE ATTACK ON CONGRESSMAN RYAN'S PARTY. THE GOG HAS ALSO REQUESTED SOME SPARE PARTS FOR AIRCRAFT IN ITS MILITARY INVENTORY. WE HAVE ASKED THE EMBASSY TO PROVIDE ADDITIONAL IDENTIFYING INFORMATION ON THE PARTS/ DOD MAY HAVE THE ITEMS; HOWEVER, THE QUESTION OF HOW THEY WILL BE PAID FOR REMAINS TO BE RESOLVED. THE LATEST WORD FROM AID IS THAT REGULATIONS PROHIBIT AID FROM FUNDING MILITARY TRANSPORTATION EQUIPMENT.

4

THE AMBASSADOR MANN IS SCHEDULED TO CALL ON ACTING
S. TIES, EMB CHRISTOPHER ON NOVEMBER 22 AT 2:30 P.M. WE
OF THE EXPECT THAT THE PURPOSE OF THE CALL WILL BE FOR THE AM-
BASSADOR TO EXPRESS CONDOLENCES AND OFFER THE CONTINUING
COOPERATION OF HIS GOVERNMENT. MR. CHRISTOPHER MAY HAVE
AN OPPORTUNITY TO PRESS FOR A GUYANESE INVITATION FOR A
VISIT BY AN FBI TEAM. THE FBI IS VERY ANXIOUS TO ASSIST
THE GUYANESE GOVERNMENT IN ITS INVESTIGATION OF THE PEOPLE'S
TEMPLE INCIDENT. AN FBI TEAM WAS EN ROUTE YESTERDAY, BUT
WAS PULLED OFF THE PLANE AT THE LAST MOMENT, AT THE REQUEST
OF GUYANESE MINISTER GREEN, WHO INFORMED THE AMBASSADOR
THAT THE PRESENCE OF THE FBI TEAM WOULD PRESENT A POLITICAL
PROBLEM FOR THE GOVERNMENT.

~~CONFIDENTIAL~~

~~CONFIDENTIAL~~

PAGE 04

STATE 295682 TOSEC 130007

7. THE STAFF DIRECTOR OF THE HOUSE INTERNATIONAL RELATIONS
COMMITTEE HAS INFORMED H THAT CHAIRMAN ZABLOCKI WILL BE

5

SENDING A LETTER TO THE DEPARTMENT CONTAINING MANY QUESTIONS ABOUT THE DEPARTMENT'S ROLE PRIOR TO THE EVENTS IN GUYANA. STAFFERS ARE NOW WORKING ON THE QUESTIONS, WHICH LIKELY WILL COVER ALL ISSUES RAISED IN THE PRESS AND MORE. A DECISION ON POSSIBLE HEARINGS WILL BE MADE AFTER RECEIPT OF THE DEPARTMENT'S RESPONSE.

8. IN RESPONSE TO A REQUEST FROM THE VICE PRESIDENT'S OFFICE, WE HAVE DETERMINED THAT THE VICE PRESIDENT DID NOT SEND A LETTER OF SUPPORT TO PEOPLE'S TEMPLE LEADER JONES. ACCORDING TO CHRISTOPHER NASCIMIENTO, A GUYANESE OFFICIAL NOW IN NEW YORK, THE QUOTES IN A PEOPLE'S TEMPLE BOOKLET ATTRIBUTED TO VICE PRESIDENT MONDALE WERE TAKEN FROM STATEMENTS THE VICE PRESIDENT SUPPOSEDLY MADE, POSSIBLY DURING THE 1976 CAMPAIGN IN CALIFORNIA. CHRISTOPHER

6

PAGE 01

GEORGE 03861 221417Z

ACTION ARA-15

27 Nov 78 14 54z

(1)

Assoc. Dir.	_____
Dep. AD Adm.	_____
Dep. AD Inv.	_____
Asst. Dir.:	_____
Adm. Serv.	_____
Crim. Inv.	14/8
Ident.	_____
Int'l.	_____
Laboratory	_____
Legal Coun.	_____
Plan. & Insp.	_____
Rec. Mgnt.	_____
Tech. Servs.	_____
Training	_____
Public Affs. Off.	_____
Telephone Rm.	_____
Director's Sec'y	_____

INFO OCT-01 ISO-00 SS-15 SP-02 NSCE-00 FBI-00 JUSE-00

L-03 H-01 CA-01 INR-10 SSO-00 INRE-00 /048 W

-----012209 221439Z /44 S

O 221415Z NOV 78

FM AMEMBASSY GEORGETOWN

TO SECSTATE WASHDC NIACT IMMEDIATE 8135

ALL INFORMATION CONTAINED
HEREIN IS UNCLASSIFIED
DATE 9/12/92 BY 1048 DFM/...

Declass per State let 2/16/2005

UC65179DMH/ST/bpg

~~CONFIDENTIAL~~ GEORGETOWN 0001

FEDERAL GOVERNMENT

b6 per FBI
b7C

E.O. 11652: GDS

TAGS: CASC, OREP (RYAN, LEO) GY

SUBJECT: FBI PRESENCE IN GUYANA.

Rymur

9
OR
WR

REF: A. GEORGETOWN 3850SB. STATE 295263

REC-126

DE-15

89-4286-61

1. AT 0830 A.M. NOVEMBER 22 AMBASSADOR TOOK LEGAL ATTACHE

OGLESBY TO CALL ON POLICE COMMISSIONER BARKER. BARKER

WELCOMED OGLESBY'S OFFER OF ASSISTANCE IN THE INVESTIGATION

22 NOV 24 1978

IN THE JONESTOWN INCIDENT AS WELL AS THE ASSASSINATION OF

CONGRESSMAN RYAN AND OTHERS AT PORT KAITUMA ON NOV 18.

HE DID NOTE, HOWEVER, THAT IT WOULD BE POLITICALLY SENSITIVE FOR

THE GOG WERE THE FBI TO LAUNCH A DIRECT INVESTIGATION IN-

COUNTRY. AFTER A BRIEF DISCUSSION BETWEEN COMMISSIONER

BARKER, THE AMBASSADOR AND LEGATT, THE COMMISSIONER CALLED

IN THREE OF HIS SENIOR AIDES TO JOIN WITH THE LEGATT IN A

MORE DETAILED DISCUSSION OF THE PROBLEM.

58 NOV 28 1978

2. AMBASSADOR THEREON LEFT MR. OGLESBY WITH POLICE
OFFICIALS AND RETURNED TO THE EMBASSY.

BURKE

NOTE BY OC/T: DISTRIBUTION CO-ORDINATED WITH S/S-O MR. RAPOPORT.

~~CONFIDENTIAL~~

cc. Ci-3

2

PAGE 01 STATE 295259 TOSEC 130004

ORIGIN ARA-15

22 Nov 78 05 07Z *nd*

INFO OCT-01 EUR-12 NEA-11 ~~CC ISO-00~~ H-01 SS-15 SY-05
 INR-10 CA-01 MCT-02 SCS-06 PA-01 AID-05 OC-06
 L-03 CG-00 CCO-00 SYE-00 SSO-00 NSCE-00 USSS-00
 INRE-00 TRSE-00 DODE-00 CIAE-00 FBIE-00 JUSE-00
 NSAE-00 DOTE-00 /094 R

Assoc. Dir.	
Dep. AD Adm.	
Dep. AD Inv.	
Asst. Dir.:	
Adm. Serv.	<i>WVA</i>
Crim. Inv.	<input checked="" type="checkbox"/>
Ident.	
Intell.	
Laboratory	
Legal Coun.	
Plan. & Insp.	
Rec. Mgnt.	
Tech. Servs.	
Training	
Public Affs. Off.	
Telephone Rm.	
Director's Sec'y	

FEDERAL GOVERNMENT

ALL INFORMATION CONTAINED
HEREIN IS UNCLASSIFIED
DATE 9/17/92 BY 1048 JEM/ndh

DRAFTED BY ARA:GWG [redacted] CFC

APPROVED BY ARA [redacted]

S/S-C [redacted]

Rymur

b6 per FBI
b7C

b6 per FBI
b7C

-----002631 220452Z /21

O 220301Z NOV 78 ZFF4

FM SECSTATE WASHDC

TO AMEMBASSY GEORGETOWN IMMEDIATE

USDEL SECRETARY IMMEDIATE

AMEMBASSY PANAMA IMMEDIATE

AMEMBASSY CARACAS IMMEDIATE

AMEMBASSY PORT OF SPAIN IMMEDIATE

AMEMBASSY LONDON IMMEDIATE

AMEMBASSY PARAMARIBO IMMEDIATE

AMEMBASSY KUWAIT IMMEDIATE

CINCSOUTHCOM QUARRY HTS CANAL ZONE IMMEDIATE

CINCMAC SCOTT AFB ILL IMMEDIATE

US REDCOM/RCJ2 MACDILL AFB FLA IMMEDIATE

USCINCARRED FT MCPHERSON GA IMMEDIATE

✓ COR 1st AIRBORNE CORPS FT BRAGG NC IMMEDIATE

USCINCEUR VAHINGEN GE ATTN: J-2 IMMEDIATE

REC-126

89-4286-62

22 NOV 24 1978

Handwritten signature

Declass per State let 2/16/2005
UC65179DMH/ST/bpg

58 NOV 28 1978

~~CONFIDENTIAL~~ STATE 295259 TOSEC 1300

LONDON FOR MICHAEL FINLEY, TOKYO FOR SENATOR HAYAKAWA

E.O. 11652: GDS

TAGS: CASC, OREP (RYAN, LEO), GY

~~CONFIDENTIAL~~

2

~~CONFIDENTIAL~~

PAGE 02

STATE 295259 TOSEC 130004

SUBJECT: SITUATION REPORT NO. 11

REF: STATE AND PREVIOUS

1. THE GUYANESE CABINET HAS OFFICIALLY REQUESTED THE USG TO REMOVE ALL REMAINS FROM GUYANESE TERRITORY ASAP. THIS DECISION WAS CONVEYED TO OUR AMBASSADOR AND DCM BY PM BURNHAM. THERE IS ALSO A RUMOR THAT THE GOG IS PLANNING TO RELEASE A LIST OF 150 VICTIMS SHORTLY, AND WE ARE EXPECTING DELIVERY OF THE 800 AMERICAN PASSPORTS RECOVERED BY THE GOG TO THE EMBASSY SHORTLY.

2. US ASSETS ON THE GROUND AT THIS TIME INCLUDE TWO HELICOPTERS (ONE HUEY, ONE OH-58), ONE U-21, TWO C-130S (SCHEDULED TO LEAVE SOON), AND ONE C-141 DUE TO DEPART TODAY AT 1600 EST. EN ROUTE ARE TWO C-141S, ONE CONTAINING CONSULAR PERSONNEL AND EQUIPMENT (DUE TONIGHT) AND ONE WITH ADDITIONAL EQUIPMENT AND THE GRAVES REGISTRATION TEAM (DUE 2120 EST). DUE TOMORROW FROM PUERTO RICO ARE THREE HH-53 "JOLLY GREEN GIANT" HELICOPTERS.

3

3. THE DOD COMMUNICATIONS TEAM HAS ARRIVED IN-COUNTRY BUT IS NOT YET ESTABLISHED IN JONESTOWN AND ON THE . TWO

CONSULAR OFFICERS WILL ALSO GO TO JONESTOWN SOON, EITHER TONIGHT OR TOMORROW MORNING.

4. THE GOG HAS REQUESTED TWO REPLACEMENT AIRCRAFT FOR THE GUYANA AIRWAYS CORPORATION; THIS REQUEST IS UNDER STUDY BY AID. THE GOG ALSO WANTS HELICOPTER SPARE PARTS AND OTHER RELATED EQUIPMENT. SINCE THE GOG IS NOT ELIGIBLE FOR FMS WE ARE REVIEWING THIS REQUEST TO DETERMINE HOW TO PROVIDE ITEMS NEEDED AS A RESULT OF THIS EMERGENCY.

~~CONFIDENTIAL~~

4

~~CONFIDENTIAL~~

PAGE 03

STATE 295259 TOSEC 130004

5. AID IS DOING CONTINGENCY PLANNING ON REQUIREMENTS FOR TEMPORARY LODGING (TENTS), FEEDING AND MEDICAL SUPPLIES FOR JONESTOWN SURVIVORS.
6. WE HAVE ASKED THE EMBASSY TO ADVISE US AS TO ADDITIONAL STAFFING REQUIREMENTS. THE EMBASSY IS REVIEWING ITS NEEDS.
7. GUYANESE AMBASSADOR LAURENCE E. MANN IS RETURNING TO WASHINGTON TONIGHT. HE HAS REQUESTED APPOINTMENT WITH THE ACTING SECRETARY TOMORROW.
8. COST ESTIMATES FOR OUR EFFORTS IN GUYANA TO DATE ARE VERY PRELIMINARY, BUT FOR AIRLIFT ALONE PROBABLY IN THE NEIGHBORHOOD OF DOLS 1.5 MILLION. CHRISTOPHER

5

PAGE 01 STATE 295410

ORIGIN ARA-15

22 Nov 78 06 45 *nd*

INFO OCT-01 ISO-00 H-01 SS-15 ^{RECEIVED} ^{FEDERAL BUREAU} ^{OF INVESTIGATION} INR-10 CA-01
COMMUNICATIONS SECTION

MCT-02 SCS-06 PA-01 AID-05 SYE-00 CCO-00 OC-06

SSO-00 NSCE-00 USSS-00 INRE-00 TRSE-00 DOTE-00

CIAE-00 ~~FBIE-00~~ JUSE-00 NSAE-00 CG-00 L-03 /071 R

FEDERAL GOVERNMENT

Assoc. Dir.	
Dep. AD Adm.	
Dep. AD Inv.	
Asst. Dir.:	
Adm. Serv.	<input checked="" type="checkbox"/>
Crim. Inv.	<input checked="" type="checkbox"/>
Ident.	
Intell.	
Laboratory	
Legal Coun.	
Plan. & Insp.	
Rec. Mgmt.	
Tech. Servs.	
Training	
Public Affs. Off.	
Telephone Rm.	
Director's Sec'y	

ALL INFORMATION CONTAINED
 HEREIN IS UNCLASSIFIED
 DATE 9/12/92 BY 1048 DKA/edm

DRAFTED BY ARA/ECP:ODONNEL:MG
 APPROVED BY ARA:JABUSHNELL
 S/S-O:JTHYDEN

Rymur

nd

-----004126 220555Z /21

O 220524Z NOV 78
 FM SECSTATE WASHDC
 TO JCS WASHDC IMMEDIATE 1675
 INFO AMEMBASSY GEORGETOWN IMMEDIATE
 SECDEF WASHDC IMMEDIATE
 CINCMAC SCOTT AFB IMMEDIATE
 CINCOS QUARRY HIGHTS CZ IMMEDIATE

REC-126

89-4286-63

22 NOV 24 1978

b6 per FB
 b7c

LIMITED OFFICIAL USE STATE 295410

E.O. 11652: N/A

58 NOV 28 1978
 TAGS: GY, CASC, OREP

SUBJECT: TRANSPORTATION OF JONESTOWN SURVIVORS

REF: (A) TELCON VAKY/AARON, 11/19/78; (B) TELCON AARON
DEPSEC DEF DUNCAN, 11/19/78

1. TELCONS (REF A AND B) AUTHORIZED DOD TO PROVIDE
SUPPORT AS REQUESTED BY SECSTATE TO SUPPORT OPERATIONS
ASSOCIATED WITH JONESTOWN DISASTER.

2. THIS IS TO ALERT YOU OF THE POSSIBILITY THAT US
MILITARY AIRCRAFT WILL BE NEEDED TO EVACUATE JONESTOWN

LIMITED OFFICIAL USE

LIMITED OFFICIAL USE

PAGE 02

STATE 295410

SURVIVORS FROM GEORGETOWN TO THE UNITED STATES.

3. FURTHER DETAILS WILL FOLLOW BY MOST EXPEDIENT
MEANS. CHRISTOPHER

LIMITED OFFICIAL USE

38276

Assoc. Dir.	_____
Dep. AD Adm.	_____
Dep. AD Inv.	_____
Asst. Dir.:	
Adm. Serv.	_____
Crim. Inv.	_____
Ident.	_____
Intell.	_____
Laboratory	_____
Legal Coun.	_____
Plan. & Insp.	_____
Rec. Mgnt.	_____
Tech. Servs.	_____
Training	_____
Public Affs. Off.	_____
Telephone Rm.	_____
Director's Sec'y	_____

PAGE 01 STATE 295260

ORIGIN SCS-06

22 Nov 78 04 18 Z

RECEIVED
FEDERAL BUREAU
OF INVESTIGATION
COMMUNICATIONS SECTION

INFO OCT-01 ARA-11 ISO-00 CA-01 FBI-00 CIAE-00 DODE-00

PA-01 TRSE-00 MCT-02 INR-10 INRE-00 SY-05 SYE-00

USSS-00 H-01 AID-05 SS-15 SSO-00 NSCE-00 CCO-00

OC-06 JUSE-00 NSAE-00 ICAE-00 CG-00 DOTE-00 L-03

1067 R

FEDERAL GOVERNMENT

ALL INFORMATION CONTAINED
HEREIN IS UNCLASSIFIED
DATE 9/12/92 BY [signature]

DRAFTED BY CA/OCS/ MWHITE:DG

APPROVED BY ARA/ JBUSHNELL

S/S-O/JTHYDEN

Rymur

res
[signature]
[signature]

b6 per FBI
b7c

-----002773 220409Z / 64

O 220333Z NOV 78

FM SECSTATE WASHDC

TO AMEMBASSY GEORGETOWN IMMEDIATE

REC-129

89-4286-64

22 NOV 24 1978

LIMITED OFFICIAL USE STATE 295260

E.O. 11652; N/A

TAGS: CASC, CDES (PEOPLE'S TEMPLE)

SUBJECT: DEPT. ASSUMPTION OF DEATH AND W/W NOTIFICATION

RESPONSIBILITIES
58 NOV 28 1978

[signature]

1. DEPARTMENT HAS BEEN INFORMED BY SUZANNE JONES, ADOPTED
ELDEST CHILD OF JIM JONES, LEADER OF THE PEOPLE'S TEMPLE,
THAT HER BROTHER, STEPHAN JONES, HAS RELEASED TO GUAYANA
AUTHORITIES THE NAMES OF APPROXIMATELY FORTY MEMBERS OF
THE TEMPLE WHO HAVE SURVIVED AND WERE WITH HIM AT THE
PEOPLE'S TEMPLE HEADQUARTERS HOUSE IN GEORGETOWN. PLEASE
ATTEMPT TO OBTAIN A LIST OF SUCH MEMBERS AND REPORT THEIR
WHEREABOUTS AND NAMES TO THE DEPARTMENT . CHRISTOPHER

LIMITED OFFICIAL USE

2

22 Nov 78 21 45z

RECEIVED
FEDERAL BUREAU
OF INVESTIGATION
COMMUNICATIONS SECTION

UNCLASSIFIED

FBB334

Assoc. Dir.	
Dep. AD Adm.	
Dep. AD Inv.	
Asst. Dir.:	
Adm. Serv.	
Crim. Inv.	<i>M/S</i>
Ident.	
Intell.	
Laboratory	
Legal Coun.	
Plan. & Insp.	
Rec. Mgmt.	
Tech. Serv.	
Training	
Public Affs. Off.	
Telephone Rm.	
Director's Sec'y	

PAGE 01

STATE 295999

FBI
ALL INFORMATION CONTAINED
HEREIN IS UNCLASSIFIED
DATE 9/17/92 BY 1048 DCM/uds

ORIGIN ARA-15

FEDERAL GOVERNMENT

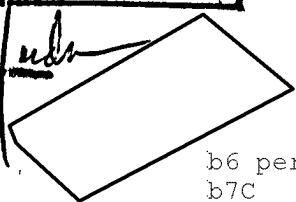

b6 per FBI
b7C

INFO OCT-01 ISO-00 SCS-06 CA-01 FBIE-00 CIAE-00 INR-10
 SAE-00 DODE-00 PA-02 TRSE-00 MCT-02 INRE-00 SY-05
 SSS-00 SYE-00 H-02 AID-05 SS-15 SSO-00 NSCE-00
 CC0-00 OC-06 JUSE-00 ICAE-00 CG-00 DOTE-00 L-03
 AS-02 /075 R

ORy mur

DRAFTED BY ARA:GBROWN:JE

APPROVED BY ARA:JABUSHNELL

S/S-0:SVALERGA

89-4286-65

REC-129

-----021726 222132Z /64-----

O 222106Z NOV 78

22 NOV 24 1978

FM SECSTATE WASHDC

TO AMEMBASSY GEORGETOWN IMMEDIATE

AMEMBASSY CARACAS IMMEDIATE

AMEMBASSY BOGOTA IMMEDIATE

AMEMBASSY PORT OF SPAIN IMMEDIATE

AMEMBASSY PANAMA IMMEDIATE

AS

580103/11
STATE 295999
28 1978

E.O. 11652: N/A

TAGS: CASC, OREP (RYAN, LEO), GY

SUBJECT: FBI INVESTIGATION

1. NEW YORK TIMES STORY NOV 22 ON FBI INVESTIGATION OF MURDER OF CONGRESSMAN RYAN CONTAINED FOLLOWING WITH RESPECT TO GUYANA:

BEGIN QUOTE: THE INVESTIGATION WAS STARTED UNDER A 1971 LAW THAT GIVES THE DEPARTMENT JURISDICTION TO INVESTIGATE CONGRESSIONAL ASSASSINATIONS, ACCORDING TO ROBERT HAVEL, THE SPOKESMAN. HE SAID THE FEDERAL BUREAU OF INVESTIGATION HAS ALREADY PLACED ONE AGENT "ON THE GROUND" IN

UNCLASSIFIED

UNCLASSIFIED

PAGE 02

STATE 295999

22 NOV 78 21 45z

GUYANA, WHERE MR. RYAN WAS MURDERED AND WHERE MORE THAN
400 AMERICANS IN THE PEOPLE'S TEMPLE SECT COMMITTED
SUICIDE.

RECEIVED
FEDERAL BUREAU OF INVESTIGATION
COMMUNICATIONS SECTION

THE AGENT, WHO WILL PROBABLY BE JOINED BY OTHERS, WILL
BE WORKING WITH GUYANESE AUTHORITIES, MR. HAVEL SAID. BUT
UNDER THE AUTHORITY OF THE CONGRESSIONAL ASSASSINATION
ACT, HE SAID, THE DEPARTMENT CAN PURSUE INVESTIGATIONS
OUTSIDE UNITED STATES TERRITORY. END QUOTE.

2. AT NOON BRIEFING BUSHNELL RESPONDED TO QUESTIONS ON
THIS SUBJECT AS FOLLOWS:

BEGIN QUOTE: Q. MR. BUSHNELL, THE JUSTICE DEPARTMENT IS
IN PROGRESS ON AN INVESTIGATION OF VIOLATIONS OF FEDERAL
LAW INVOLVING THE ASSASSINATION OF A CONGRESSMAN. YESTER-
DAY GUYANESE AUTHORITIES DECLINED TO ADMIT TO 10 FBI
AGENTS WHO WERE PREPARED TO GO DOWN THERE. ARE THE
GUYANESE AUTHORITIES COOPERATING WITH THE ONE FBI AGENT
ON THE SPOT IN THEIR CURRENT INVESTIGATION OR ARE THEY
PASSING ON TO HIM THE RESULTS OF THEIR INVESTIGATION OR
ALLOWING HIM TO PARTICIPATE IN THAT INVESTIGATION?

A., THIS MORNING THE LEGAL ATTACHE FROM CARACAS MET WITH
THE GUYANESE OFFICIALS, MET WITH THE GUYANESE POLICE
CHIEF, INVESTIGATING CHIEF, IN GEORGETOWN. THE LAST
REPORT I HAD WAS THAT HE WAS STILL MEETING WITH THEM,
THAT HE WAS COOPERATING IN THIS INVESTIGATION. WE HAVE
MADE CLEAR TO THE GUYANESE THAT AS IN OTHER AREAS, WE
ARE PREPARED TO PROVIDE ADDITIONAL ASSISTANCE, TECHNICAL,
INVESTIGATIVE ASSISTANCE TO HELP THEM IN GUYANA. WE
ARE PREPARED TO FOLLOW UP WITH NECESSARY INTERVIEWS AND
INVESTIGATIONS IN THE UNITED STATES, BUT THE FULL COOPERA-
TION OF THE FBI WILL BE AVAILABLE IN THIS CASE. UNTIL

UNCLASSIFIED

UNCLASSIFIED

PAGE 03

STATE 295999

THE LEGAL ATTACHE WHO IS WORKING WITH THEM AND THE GUYANESE OFFICIALS THEMSELVES ASSESS PRECISELY WHAT SORT OF HELP IS NEEDED, WHAT SORT OF EXPERTISE, THE GUYANESE HAVE FELT THAT IT WAS PREMATURE TO SEND DOWN A GENERAL INVESTIGATIVE TEAM. IT'S THEIR INVESTIGATION, THE INVESTIGATION IN GUYANA. THEY ARE A SOVEREIGN COUNTRY AND WE ARE NOT TRYING IN ANY WAY TO TAKE IT OVER.

I THINK, FROM THE CONVERSATIONS THAT I HAVE HAD AND THAT OUR AMBASSADOR HAS HAD, THAT THERE WILL BE ADDITIONAL SPECIFIC REQUESTS FOR ASSISTANCE FROM THE FBI IN ASPECTS OF THIS INVESTIGATION. THE INVESTIGATION IS, OF COURSE, MAKING PROGRESS, AS INDICATED BY THE FACT THAT THERE HAS ALREADY BEEN THE FIRST ARREST AND CHARGE, AND THAT WE ARE EXPECTING OTHERS TO PROCEED FAIRLY PROMPTLY.

Q. IF I COULD FOLLOW UP MY OWN QUESTION, THE THRUST OF YOUR REPLY IS THAT THE FBI IS PREPARED TO COOPERATE WITH GUYANESE AUTHORITIES. WHAT I ASKED WAS: ARE GUYANESE AUTHORITIES PREPARED TO COOPERATE WITH THE FBI IN THEIR INVESTIGATION?

A. I THINK THE ANSWER IS CLEARLY YES IN THE FACT THAT THEY ARE WORKING RIGHT NOW WITH THE FBI MAN. SO THAT, NOT ONLY ARE THEY PREPARED TO COOPERATE, THEY ARE COOPERATING. END QUOTE. CHRISTOPHER

UNCLASSIFIED

Assoc. Dir.	
Dep. AD Adm.	
Dep. AD Inv.	
Asst. Dir.:	
Adm. Serv.	
Crim. Inv.	<i>MPS</i>
Ident.	
Intell.	
Laboratory	
Legal Coun.	
Plan. & Insp.	
Rec. Mgnt.	
Tech. Servs.	
Training	
Public Affs. Off.	
Telephone Rm.	
Director's Sec'y	

PAGE 01

STATE 295988

ORIGIN SCS-06

22 Nov 78 21 48z

INFO OCT-01 ARA-15 ISO-00 CA-01 FBI-00 CIAE-00 INR-10
 NSAE-00 PA-02 TRSE-00 MCT-02 ^{FEDERAL BUREAU OF INVESTIGATION} COMMUSY-05 IS SSTE-00 USSS-00
 H-02 AID-05 SS-15 OC-06 CCO-00 JUSE-00 CG-00
 DOTE-00 L-03 SSO-00 NSCE-00 INRE-00 ICAE-00 /073

FBI
 ALL INFORMATION CONTAINED
 HEREIN IS UNCLASSIFIED
 DATE 9/17/92 BY 1088 DCM/Adm

DRAFTED BY CA/SCS:RDAVIS:JE

APPROVED BY ARA:JABUSHNELL

FEDERAL GOVERNMENT

S/SO:SVALERGA

-----021696 222125Z /73

b6 per FBI
b7C

O 222054Z NOV 78 ZFF4

FM SECSTATE WASHDC

Rymar

re

TO AMEMBASSY GEORGETOWN NIACT IMMEDIATE

INFO JCS WASHDC IMMEDIATE IMMEDIATE 1677

SECDEF WASHDC IMMEDIATE 2068

CINCMAC IMMEDIATE

CINCSOUTH IMMEDIATE

REC-129

89-4286-66

22 NOV 24 1978

UNCLAS STATE 295988

E.O. 11652: N/A

TAGS: CASC, OREP (RYAN, LEO), GY

SUBJECT: DESTINATION OF AIRCRAFT

THIS WILL CONFIRM INFO RELAYED BY PHONE THAT DESTINATION
OF AIRCRAFT CARRYING REMAINS WILL BE U.S. AIR FORCE

58 NOV 28 1978 NORTH WYOMING AIR FORCE BASE, DOVER, DELAWARE.. CHRISTOPHER

PAGE 01 STATE 295993

ORIGIN ARA-15

22 Nov 78 21 47z

INFO OCT-01 ISO-00 SCS-06 CA-01 ~~FBIE-00~~ JUSE-00 L-03
CIAE-00 INR-10 NSAE-00 ~~SY-125~~ ~~CA-01~~ ~~SECTION~~ H-01 SSO-00
INRE-00 /044 R

Assoc. Dir.	
Dep. AD Adm.	
Dep. AD Inv.	
Asst. Dir.:	
Adm. Serv.	
Crim. Inv.	<i>MS</i>
Ident.	
Intell.	
Laboratory	
Legal Coun.	
Plan. & Insp.	
Rec. Mgmt.	
Tech. Servs.	
Training	
Publ. Affs. Off.	
Talent Rm.	
Director's Sec'y	

(S)
ALL INFORMATION CONTAINED
HEREIN IS UNCLASSIFIED
DATE *9/17/92* BY *1048 DKM/m*

DRAFTED BY ARA/GWG: [redacted]

APPROVED BY ARA: [redacted] b6 per FBI b7C

S/S-O: SVALERGA
CA/SCS-R DAVIS

FEDERAL GOVERNMENT b6 per FBI b7C

-----021755 222130Z /73

O 222104Z NOV 78
FM SECSTATE WASHDC
TO AMEMBASSY CARACAS IMMEDIATE

(S)
Py mur

~~CONFIDENTIAL~~ STATE 295993

E.O. 11652: GDS

89-4286-67

TAGS: CASC, OREP, GY

REC-129

22 NOV 24 1978

SUBJECT: GUYANA SITUATION

Declass per State let 2/16/2005
UC65179DMH/ST/bpg

REF: CARACAS 11013

AG

REGARDING ANY MEMBERS OF JONESTOWN COMMUNITY WHO MAY FIND
THEIR WAY TO VENEZUELA WE URGENTLY NEED IDENTIFYING DATA
AND INDICATION OF INTENDED ONWARD MOVEMENT. COORDINATE

WITH OFFICE OF LEGAL ATTACHE. CHRISTOPHER

58 NOV 28 1978

Assoc. Dir.	_____
Dep. AD Adm.	_____
Dep. AD Inv.	_____
Asst. Dir.:	_____
Adm. Serv.	_____
Crim. Inv.	_____
Ident.	_____
Intell.	_____
Laboratory	_____
Legal Coun.	_____
Plan. & Insp.	_____
Rec. Mgmt.	_____
Tech. Servs.	_____
Training	_____
Public Affs. Off.	_____
Telephone Rm.	_____
Director's Sec'y	_____

UNCLASSIFIED 22 Nov 78 EBB326 122 JK

RECEIVED
FEDERAL BUREAU
OF INVESTIGATION
COMMUNICATIONS SECTION

PAGE 01 STATE 295932

ORIGIN ARA-15

INFO OCT-01 ISO-00 SSO-00 NSCE-00 INRE-00 ICAE-00

CIAE-00 DODE-00 PM-05 H-02 INR-10 L-03 NSAE-00

PA-02 SP-02 SS-15 SY-05 SYE-00 FBIE-00 MCT-02

SCS-06 CA-01 JUSE-00 TRSE-00 /069 R

b6 per FBI
b7C

ALL INFORMATION CONTAINED
HEREIN IS UNCLASSIFIED
DATE 9/17/92 BY 1048 DKN/udm
(res)

FEDERAL GOVERNMENT

(Orymur)

DRAFTED BY ARA:GBROWN:JE

APPROVED BY ARA:JABUSHNELL

S/S-O:SVALERGA

-----018617 221942Z /53

O 221827Z NOV 78

FM SECSTATE WASHDC

REC-129

89-4286-68

TO AMEMBASSY GEORGETOWN IMMEDIATE

22 NOV 24 1978

INFO AMEMBASSY CARACAS IMMEDIATE

AMEMBASSY BOGOTA IMMEDIATE

AMEMBASSY PORT OF SPAIN IMMEDIATE

(RST)

UNCLAS STATE 295932

E.O. 11652: N/A

58 NOV 21 1978
CASE, ORLP (RYAN, LEO), GY

Assoc. Dir. _____
 Dep. AD Adm. _____
 Dep. AD Inv. _____
 Asst. Dir.:
 Adm. Serv. _____
 Crim. Inv. M/S
 Ident. _____
 Intel. _____
 Laboratory _____
 Legal Coun. _____
 Plan. & Insp. _____
 Rec. Mgnt. _____
 Tech. Servs. _____
 Training _____
 Public Affs. Off. 3
 Telephone Rm. _____
 Director's Sec'y _____

22 Nov 78 21 09z

UNCLASSIFIED

FBB328X

RECEIVED
 FEDERAL BUREAU
 OF INVESTIGATION
 COMMUNICATIONS SECTION

PAGE 01

GEORGE 03875 222011Z

ACTION SCS-06

FEDERAL GOVERNMENT INFORMATION CONTAINED
 HEREIN IS UNCLASSIFIED
 DATE 9/17/92 BY 1048 DGM/mk

INFO OCT-01 ARA-15 ISO-00 CA-01 H-02 SS-15 NSCE-00

CIAE-00 INR-10 NSAE-00 DODE-00 PA-02 FBIE-00

MCT-02 SY-05 PPTE-00 SYE-00 INRE-00 SSO-00 /059 W

b6 per FBI
 b7C

-----019816 222050Z /44

0 221915Z NOV 78

Orymur

89-4286-69

FM AMEMBASSY GEORGETOWN

22 NOV 24 1978

TO SECSTATE WASHDC NIACT IMMEDIATE 8144

REC-129

UNCLAS GEORGETOWN 3875

E.O. 11652: N/A

TSGS: CDES, GY (AMOS, LINDA SHARON, (HARRIS, LIANE)

38 NOV 28 1978 ✓ SUBJECT: DISCOVERY OF REMAINS (SHARON AMOS & 3 CHILDREN)

REF: A) GEORGETOWN 3818

B) STATE 293789

C) GEORGETOWN 3789

1. POST MORTEM EXAMINATIONS OF THE FOUR CORPSES HAS JUST BEEN
COMPETED. HOSPITAL REQUESTS IMMEDIATE INSTRUCTIONS CONCERNING
DISPOSITION OF REMAINS.

2. LIANE'S FATHER, SHERWIN HARRIS IS KNOWN NOX OF LIANE. AMOS'
NOX STILL UNKNOWN.

3. MAY THESE FOUR BODIES BE EVACUATED VIA USAF AIRCRAFT? PLEASE
REPLY ASAP.

BURKE

2

UNCLASSIFIED

~~SECRET~~

FBB301

PAGE 01 STATE 295263

ORIGIN SS-25

22 Nov 78 17.43z *sl*

INFO OCT-01 ISO-00 SSO-00 CCO-00 (AS-01, NSCE-00, FBIE-00, JUSE-00,) R
COMMUNICATIONS SECTION

- Assoc. Dir. _____
- Dep. AD Adm. _____
- Dep. AD Inv. _____
- Asst. Dir.:
- Adm. Serv. _____
- Ident. _____
- Intell. _____
- Laboratory _____
- Legal Coun. _____
- Plan. & Insp. _____
- Rec. Mgmt. _____
- Tech. Servs. _____
- Training _____
- Public Affs. Off. _____
- Telephone Rm. _____
- Director's Sec'y _____

FBI
ALL INFORMATION CONTAINED
HEREIN IS UNCLASSIFIED
DATE 9/7/92 BY 10480KA/mjh

DRAFTED BY ARA: [redacted] MG

APPROVED BY ARA: [redacted]

S/S-C [redacted]

Rymur

b6 per FBI
b7C

-----010259 221219Z /73

0 220416Z NOV 78

FEDERAL GOVERNMENT

FM SECSTATE WASHDC

TO AMEMBASSY GEORGETOWN IMMEDIATE

~~SECRET~~ STATE 295263

REC-129

89-4286-70

EXDIS

22 NOV 24 1978

Declass per State let 2/16/2005
UC65179DMH/ST/bpg

E.O. 11652: GDS

TAGS: GY, CASC, OREP

SUBJECT: FBI IN GUYANA

REF: GEORGETOWN 3850

58NOV 28 1978

[Handwritten signature]

...Y CONCERNED THAT IT HAS NOT BEEN PERMITTED
ND SMALL TEAM OF AGENTS TO GUYANA TO ASSIST WITH
INVESTIGATION OF DEATH LARGE NUMBER OF AMERICANS. SENIOR
DOJ AND FBI OFFICIALS REGRET THAT PROMPT DECISION TO OFFER
MORE ASSISTANCE WAS NOT MADE SUNDAY. THEY HAVE NOW
DETERMINED THAT ATTACK ON CONGRESSMAN AND US DIPLOMAT NOT
ONLY JUSTIFIES BUT VIRTUALLY REQUIRES FBI EFFORTS.

MOREOVER, THEY FEEL THAT CLOSE RELATIONSHIP BETWEEN MANY
OF AMERICANS IN GUYANA AND IN THE US MEANS THAT INFORMATION
FOR CASES THEY ARE PURSUING IN THIS COUNTRY MAY BE AVAIL-
ABLE IN GUYANA, E.G. ILLEGAL US ARMS EXPORTS TO GUYANA.
STRONG FEELINGS ON THIS SUBJECT IS INDICATED BY FACT THAT
DEPUTY ATTORNEY GENERAL CIVILETTI TELEPHONED ME THIS

~~SECRET~~

~~SECRET~~

PAGE 02

STATE 295263

EVENING TO STRESS HIS STRONG CONCERN.

2. JUSTICE AND FBI SUGGEST THAT STRONGEST ARGUMENTS WITH
GOG WOULD BE FOLLOWING:

2

FBI IS CAPABLE OF PROVIDING TECHNICAL ASSISTANCE
IN MANY FIELDS INCLUDING EXPERIENCE WITH PEOPLE
OF DIVERSE CULTS.

(B) GIVEN LARGE NUMBER OF AMERICAN DEAD AND INHERENT
COMPLEXITY OF CASE, THERE WILL BE INEVITABLE ACCUSATIONS
THAT GOG INVESTIGATION DEFICIENT IN SOME RESPECTS.
ACTUAL ON-SITE PARTICIPATION OF SMALL NUMBER FBI WOULD
ENHANCE AMERICAN PUBLIC CONFIDENCE IN OUTCOME INVESTIGA-
TION.

(C) GIVEN LIKELY LINKS INVESTIGATION TO ACTIVITIES IN
US, ON-SITE PRESENCE WOULD FACILITATE COORDINATION AND
EXCHANGE WHICH MIGHT BE AT LEAST AS VALUABLE IN
GUYANESE PART OF INVESTIGATION AS IN AMERICAN
INVESTIGATION.

3. I TOLD MR. CIVILETTI THAT KEY ROLE IN DEVELOPING
GOG AGREEMENT TO ADDITIONAL FBI WILL BE PLAYED BY LEGAL
ATTACHE NOW IN COUNTRY. TO EXTENT HE CAN DEVELOP
TECHNICAL LEVEL REQUESTS FOR FBI ASSISTANCE, IT WOULD
BE MUCH EASIER FOR YOU TO OBTAIN SENIOR LEVEL APPROVAL.
I ASSURED HIM I WOULD COMMUNICATE DOJ AND FBI INTEREST
TO YOU AND ASSURED HIM YOU WOULD MAKE APPROPRIATE EFFORTS
TO OBTAIN NECESSARY INVITATION/CLEARANCES. HE SAID
FBI WOULD BE COMMUNICATING WITH LEGAL ATTACHE ALONG
LINES INDICATED ABOVE.

~~SECRET~~

3

PAGE 03

STATE 295263

4. I BELIEVE MODEST ADDITIONAL FBI PRESENCE WOULD
BE IN THE INTEREST OF BOTH GOG AND USG. THUS, I WOULD
HOPE ABOVE ARGUMENTS AND OTHERS YOU MAY DEVELOP
WILL ENABLE YOU TO ARRANGE CLEARANCES OVER NEXT COUPLE
OF DAYS. CHRISTOPHER

4

UNCLASSIFIED

FBB330

Assoc. Dir.	1
Dep. AD Adm.	1
Dep. AD Inv.	1
Asst. Dir.:	
Adm. Serv.	
Crim. Inv.	<i>WES</i>
Ident.	
Intell.	
Laboratory	
Legal Coun.	
Plan. & Insp.	
Rec. Mgnt.	
Tech. Servs.	
Training	
Public Affs. Off.	
Telephone Rm.	
Director's Sec'y	

PAGE 01

GEORGE 03879 22212Z NOV 78 21z

ACTION SCS-06

FEDERAL BUREAU OF INVESTIGATION COMMUNICATIONS SECTION

INFO OCT-01 ARA-15 ISO-00 CA-01 H-02 SS-15 NSCE-00

CIAE-00 INR-10 NSAE-00 DODE-00 PA-02 FBIE-00

MCT-02 SY-05 PPT-00 SSO-00 INRE-00 /059 W

-----021565 222112Z /64

0 222050Z NOV 78

FEDERAL GOVERNMENT

b6 per FBI
b7C

MEMBASSY GEORGETOWN

TO SECSTATE WASHDC NIACT IMMEDIATE 8159

WES

UNCLAS GEORGETOWN 3879

Rymur

ALL INFORMATION CONTAINED
HEREIN IS UNCLASSIFIED
DATE 9/10/92 BY 1088 DKY/mk

E.O. 11652: NA

TAGS: CDES, GY, (AMOS, LINDA SHARON)

REC-129

89-4286 - 71

SUBJ: FURTHER DATA ON " AMOS, SHARON"

NOV 24 1978

REF: GEORGETOWN 3818

FURTHER DATA JUST RECEIVED FROM GUYANESE IMMIGRATION; PPT

NUMBER F016301 ISSUED SAN FRANCISCO FEB. 1. 75.

MOTHER'S NAME; RHEVENIA BEAN

FATHER'S NAME: JACK BEAN

HIS ADDRESS GIVEN AS P.O. BOX 15156 SAN FRANCISCO, CALIFORNIA

BURKE

58 NOV 28 1978

SUBJECT: FBI INVESTIGATION OF RYAN DEATH

THE FBI MADE THE FOLLOWING PRESS RELEASE NOVEMBER 21:

BEGIN QUOTE: FBI DIRECTOR WILLIAM H. WEBSTER CONFIRMED TODAY THAT THE FBI IS INVESTIGATING THE MURDER OF CONGRESSMAN LEO J. RYAN OF CALIFORNIA AND THE EVENTS SURROUNDING HIS DEATH AT JONESTOWN, GUYANA.

DIRECTOR WEBSTER ADDED THE MURDER OF CONGRESSMAN RYAN IS BEING INVESTIGATED BY THE FBI UNDER THE PROVISIONS OF THE CONGRESSIONAL ASSASSINATIONS STATUTE INCLUDING CONSPIRACY PROVISIONS OF THE ACT; SINCE THOSE RESPONSIBLE FOR THE

UNCLASSIFIED

2

UNCLASSIFIED

PAGE 02

STATE 295932

DEATH OF CONGRESSMAN RYAN CAN BE PROSECUTED FOR THIS
FEDERAL OFFENSE IF THEY ARE FOUND IN OR RETURNED TO THE
JURISDICTION OF THE UNITED STATES.

SURVIVORS OF THE SHOOTING INCIDENT AT JONESTOWN ARE BEING
INTERVIEWED BY SPECIAL AGENTS OF THE FBI UPON THEIR RETURN
TO THE UNITED STATES. OTHER PERSONS WHO MIGHT HAVE
INFORMATION RELATING TO THIS INCIDENT ARE BEING INTER-
VIEWED THROUGHOUT THE UNITED STATES. FBI REPRESENTATION
IN GUYANA IS BEING COORDINATED WITH THE STATE DEPARTMENT
AND THE GOVERNMENT OF GUYANA. CHRISTOPHER

3

VV FBAS08

OO RUEHFB

DE RUESON #3895 3271930

ZNR UUUUU ZZH

O R 231900Z NOV 78

FM AMEMBASSY GEORGETOWN

TO RUEHC/SECSTATE WASHDC IMMEDIATE 8174

INFO RUEHFB/FBI WASHDC

BT

UNCLAS GEORGETOWN 3895

E.O. 11652: N/A

TAGS: CASC (PEOPLES TEMPLE)

SUBJECT: RELEASE OF SOME SURVIVORS OF PEOPLE'S TEMPLE

REF: A. GEORGETOWN 3821 B. GEORGETOWN 3853

1. POLICE OFFICIALS INDICATED TODAY THAT MOST OF THE 25 INDIVIDUALS WHO WERE STAYING AT EVE LEARY POLICE HQS WILL BE PERMITTED TO LEAVE THE COUNTRY TOMORROW (NOV24). FOR TONIGHT THEY ARE BEING MOVED TO A HOTEL WITH POLICE PROTECTION.

2. INDECISION ON THE EXACT NUMBER THAT WILL BE ALLOWED TO LEAVE THE COUNTRY SHOULD BE RESOLVED LATER THIS AFTERNOON AFTER THE POLICE DETERMINE IF MORE INFORMATION CAN BE GLEANED FROM THEM.

58 NOV 29 1978

3. THE NAMES OF THOSE WHO MAY RPT MAY BE RELEASED ARE:

J 23 NOV 78 19 51z
RECEIVED
FEDERAL BUREAU
OF INVESTIGATION
COMMUNICATIONS SECTION

FEDERAL GOVERNMENT

FBI
ALL INFORMATION CONTAINED
HEREIN IS UNCLASSIFIED
DATE 9/17/92 BY 6048 DCA/rlb

Rymur

Assoc. Dir.	_____
Dep. AD Adm.	_____
Dep. AD Inv.	_____
Asst. Dir.:	
Adm. Serv.	_____
Crim. Inv.	_____
Ident.	_____
Intell.	_____
Laboratory	_____
Legal Coun.	_____
Plan. & Insp.	_____
Rec. Mgmt.	_____
Tech. Servs.	_____
Training	_____
Publ. Affs. Off.	_____
Telephone Rm.	_____
Director's Sec'y	_____

b6 per FBI
b7C

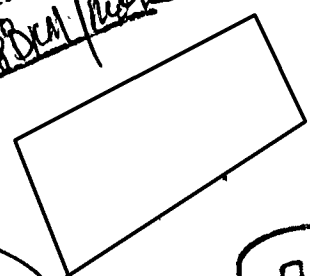

res

REC-29 89-4286-72

22 NOV 24 1978

AS

(G...)

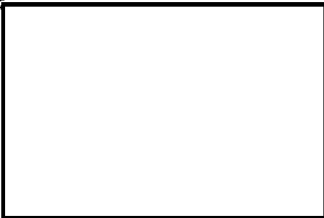

CLARKE, RICHARD



DAVIS, GROVER (POSSIBLY WILL BE ASKED TO STAY)

EVANS, JULIUS

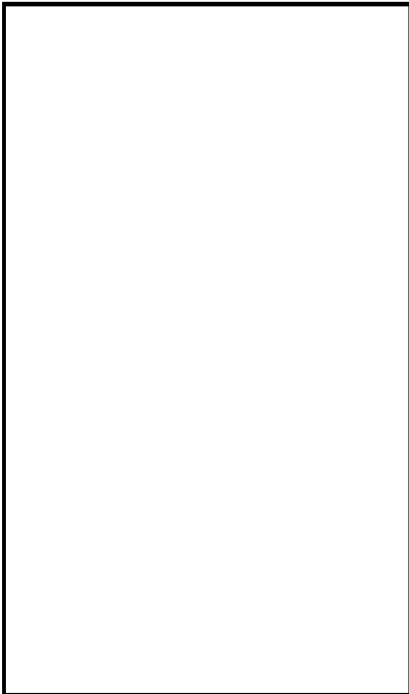

b6 Per Dept. of State

PARKS, EDITH



PAUL, ROBERT



THRASH, HYACINTH



WILSON, LESLIE

4. THOSE CURRENTLY DETAINED AT THE PEOPLE'S TEMPLE

GEORGETOWN HQS, LAMAHA GARDENS, WILL BE HELD FOR A WHILE LONGER,

PENDING INVESTIGATION INTO THE DEATHS OF SHARON AMOS AND HER

THREE CHILDREN.

5. MORE DEFINITE INFORMATION WILL BE AVAILABLE THIS AFTERNOON

AND WILL BE FORWARDED, ALONG WITH THE ADDRESSES THE MEMBERS

OF THE GROUP PLAN TO GO TO AFTER THEIR ARRIVAL IN THE STATES.

BURKE

BT

#3895

3

PAGE 01 GEORGE 03898 232155Z

ACTION SCS-06

INFO OCT-01 ARA-11 ISO-00 CA-01 PPT-01 SSO-00 SS-15

FBI-00 PA-01 H-0 COMINSCEN-00 SEV 1837 W

23 Nov 78 22 36z

-----044007 232202Z 166

O 232100Z NOV 78

FM AMEMBASSY GEORGETOWN

TO SECSTATE WASHDC NIACT, IMMEDIATE 8177

FEDERAL GOVERNMENT

FBI
ALL INFORMATION CONTAINED
HEREIN IS UNCLASSIFIED
DATE 9/17/82 BY 1046 DKJ/edn

LIMITED OFFICIAL USE GEORGETOWN 3898

Rymur

E.O. 11652: N/A

TAGS: CASC (PEOPLES TEMPLE), GY

SUBJECT: W/W: LIST OF ALL KNOWN PT MEMBERS IN GUYANA

REF: GEORGETOWN 3821, 3853, STATE 296523

89-4286-73

22 NOV 24 1978

1. THE FOLLOWING LIST OF MEMBERS OF THE PEOPLE'S TEMPLE GROUP KNOWN TO BE ALIVE AND PRESENTLY IN GUYANA COLLATES, ADDS TO AND SUPERSEDES ALL PREVIOUSLY CABLED:

ADAMS, PAULA

BAGBY, MONICA

b6 Per Dept. of State

(Handwritten signature)

BEIKMAN, CHUCK
58 NOV 29 1978
BEIKMAN, TOM

cc - Henry

Assoc. Dir.	_____
Dep. AD Adm.	_____
Dep. AD Inv.	_____
Asst. Dir.:	
Adm. Serv.	_____
Crim. Inv.	<i>NRS</i>
Ident.	_____
Intell.	_____
Laboratory	_____
Legal Coun.	_____
Plan. & Insp.	_____
Rec. Mgmt.	_____
Tech. Servs.	_____
Training	_____
Public Affs. Off.	_____
Telephone Rm.	_____
Director's Sec'y	_____

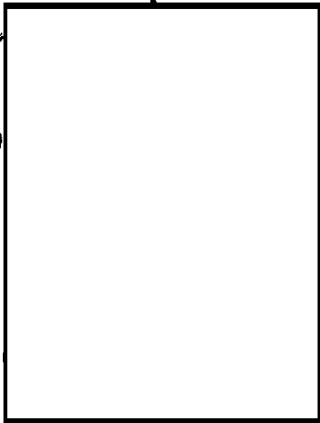

b6 Per Dept. of State

BOGUE, THOMAS

BROOKS, MADELINE

CAMPBELL, MARION



LIMITED OFFICIAL USE

2

PAGE 02

GEORGE 03898 232155Z

[REDACTED]

CLARKE, RICHARD

[REDACTED]

b6 Per Dept. of State

DAVIS, GROVER

DEPINA, MIGUEL

[REDACTED]

EVANS, JULIUS

[REDACTED]

GODSHALK, RAY

[REDACTED]

JOHNSON, RUBY

JOHNSTON, LAURA

JONES, JAMES WARREN JR.

[REDACTED]

JONES, STEPHEN

[REDACTED]

3

KENDALL, CHUCK



MITCHELL, DAWN (AKA GARDFREY)

b6 Per Dept. of State



MCCANN, PAUL



LIMITED OFFICIAL USE

4

PAGE 03

GEORGE 03898 232155Z

ORSOT, BEA (AKA GRUBBS)



PARKS, EDITH



b6 Per Dept. of State

PROKES, MICHAEL JR.

PURSELEY, JOAN



RODRIGUEZ, AURORA

SATTERWHITE, ALVARAY

SCHEID, DIANE (AKA CASANOVA)

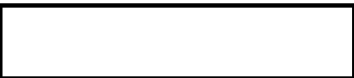

SMITH, EUGENE

STROUD, BOBBY

THRASH, HYACINTH



TOUCHETTE, MIKE



5

b6 Per Dept. of State

WILSON, LESLIE

YATES, NEDRA

YOUNG, CAROL

2. UPDATE ON NOK TO FOLLOW.

BURKE

LIMITED OFFICIAL USE

6

need copy

LIMITED OFFICIAL USE

FBB448

Assoc. Dir.	
Dep. AD Adm.	
Dep. AD Inv.	
Asst. Dir.:	
Adm. Serv.	
Crim. Inv.	<i>MPS</i>
Ident.	
Int'l.	
Laboratory	
Legal Coun.	
Plan. & Insp.	
Rec. Mgmt.	
Tech. Servs.	
Training	
Public Affs. Off.	
Telephone Rm.	
Director's Sec'y	

PAGE 01 GEORGE 03897 232031Z

ACTION SCS-06

23 Nov 78 21 30z

ALL INFORMATION CONTAINED
HEREIN IS UNCLASSIFIED
DATE 9/11/92 BY 1048 D/AM

RECEIVED
FEDERAL BUREAU
OF INVESTIGATION
COMMUNICATIONS SECTION

INFO OCT-01 ARA-11 ISO-00 CA-01 L-03 H-01 FBIE-00

CIAE-00 INR-10 NSAE-00 DODE-00 PA-01 SY-05 SS-15

SSO-00 INRE-00 JUSE-00 /054 W

Adt

(WRS)

-----043205 232052Z /64

O 232015Z NOV 78

FEDERAL GOVERNMENT

FM AMEMBASSY GEORGETOWN

TO SECSTATE WASHDC NIACT IMMEDIATE 8176

Orymur

REC-129

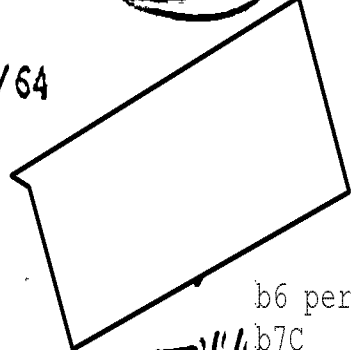

b6 per FB
b7C

89-4286-74

22 NOV 24 1978

LIMITED OFFICIAL USE GEORGETOWN 3897

E.O. 11652: N/A

TAGS: CASC, OREP, GY

SUBJECT: FINDINGS IN PARTIAL AUTOPSY ON BODY OF BISHOP JIM JONES

cc - 58 NOV 28 1978

ASE

THE OFFICIAL PATHOLOGIST OF THE GOG, DR. LESLIE C. MOOTOO,
HAS FURNISHED THE FOLLOWING INFORMATION: QUOTE: DR. MOOTOO
REPORTED THAT HE PERFORMED A PARTIAL AUTOPSY ON A BODY
IDENTIFIED TO HIM AS BEING THAT OF BISHOP JIM JONES AT
JONESTOWN ON TUESDAY, NOVEMBER 21, 1978. HE SAID THERE WAS
A SMALL BULLET ENTRY WOUND ABOVE THE RIGHT EAR, WITH A LARGE,
4 CENTIMETER EXIT WOUND BEHIND THE LEFT EAR. THE WOUNDS
APPEARED TO BE SELF-INFLICTED, USING A SMALL PISTOL WHICH
WAS FOUND LYING ON THE VICTIM'S CHEST. DR. MOOTOO SAID HE
ALSO TESTED FOR POISON AND THERE WAS NOT EVIDENCE THAT HE
HAD TAKEN ANY. A COMPLETE AUTOPSY WAS NOT DONE AS THE
CAUSE OF DEATH WAS OBVIOUS. UNQUOTE.

BURKE

LIMITED OFFICIAL USE

UNCLASSIFIED

FBB456

Assoc. Dir.	
Dep. AD Adm.	
Dep. AD Inv.	
Asst. Dir.:	
Adm. Serv.	
Crim. Inv.	<i>NPS</i>
Ident.	
Intell.	
Laboratory	
Legal Coun.	
Plan. & Insp.	
Rec. Mgmt.	
Tech. Servs.	
Training	
Public Affs. Off.	
Telephone Rm.	
Director's Sec'y	

PAGE 01

STATE 296862

23 NOV 78 22 14z

ORIGIN SCS-06

RECEIVED *TR*
FEDERAL BUREAU
OF INVESTIGATION
COMMUNICATIONS SECTION

INFO OCT-01. ARA-15 ISO-00 CA-01 FBIE-00 CIAE-00 INR-10
 NSAE-00 DODE-00 PA-02 IRSE-00 INRE-00 MCT-02 SY-05
 SYE-00 USSS-00 H-02 AID-05 SS-15 SSO-00 NSCE-00
 JUSE-00 ICAE-00 CG-00 L-03 DOTE-00 PPT-01 /068 R

b6 per FBI
b7C

DRAFTED BY CA/SCS/LCHERNANDEZ:JCC

FBI
ALL INFORMATION CONTAINED
HEREIN IS UNCLASSIFIED
DATE *9/17/92* BY *1048 DCM/ndm*

APPROVED BY ARA/JBUSHNELL

FEDERAL GOVERNMENT

S/S-O; RCASTRODALE

SCS - RGDAVIS

Rymur

WBS

-----043840 232132Z /64

O 232113Z NOV 78

FM SECSTATE WASHDC

TO AMEMBASSY GEORGETOWN IMMEDIATE

REC-129

89-4286-75

NOV 24 1978

UNCLAS STATE 296862

E.O. 11652: N/A

TAGS: CASC

ALIX
(Signature)

SUBJECT: PEOPLE'S TEMPLE MEMBERS REPORTED IN GUYANA

58 NOV 29 1978

FOLLOWING LIST OF NEW NAMES:

Pl. Ident



2. BELLE, ETHEL AGE 87

b6 Per Dept. of St



3. BLAKEY, PHILIP: DPOB: 24 U.K. CITIZEN



UNCLASSIFIED

UNCLASSIFIED

PAGE 02

STATE 296862

[Redacted]

5. COOK, BERTHA, AGE 65

[Redacted]

6. CRENSHAW, EDDIE

NOTIFY:

[Redacted]

b6 Per Dept. of St

7. CRENSHAW, LUCH

NOTIFY:

[Redacted]

(SEE HALLMAN)

8. EDWARDS, ISAAC, JR., CA., 6-8-72, EDWARDS, SHIRLEY

(CHILD).

[Redacted]

[Redacted]

3

10. FORD, FANNIE



b6 Per Dept.



12. HALLMAN, EDDIE (SEE CRENSHAW)

UNCLASSIFIED

UNCLASSIFIED

PAGE 03

STATE 296862

NOTIFY:

[Redacted]

[Redacted]

b6 Per Dept. of State

14. JOHNSON, DERRICK AGE 8

15. JOHNSON, GARY (PONCHO) 18 OR 19 YRS OLD

NOTIFY:

[Redacted]

[Redacted]

16. KUTULAS, EDITH, 45 YRS OLD. CA.,

[Redacted]

[Redacted]

[Redacted]

5

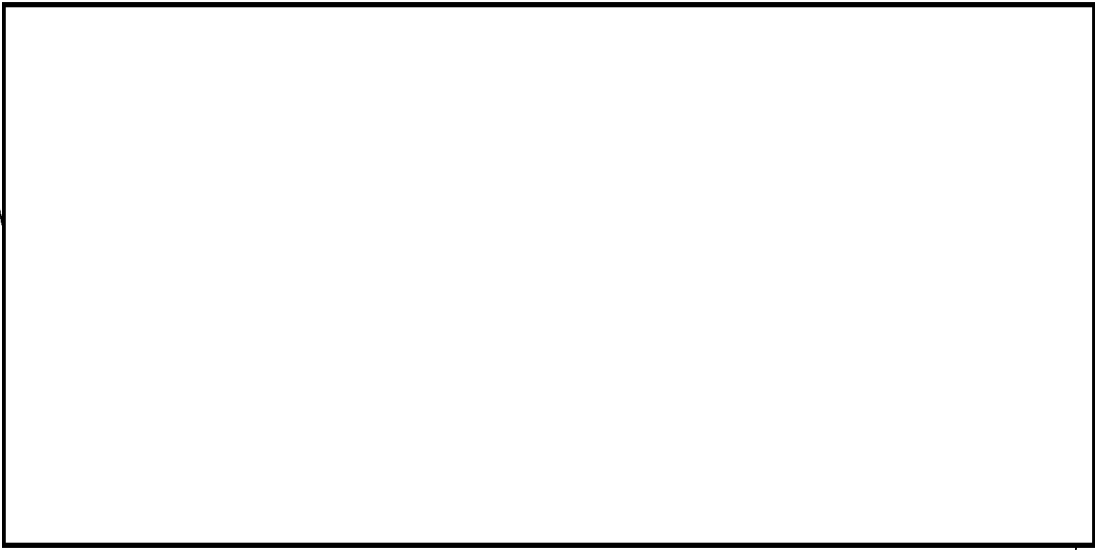

19. MCCLAIN, ALLIE, DPOB: 6/25/91 ARK.

b6 Per Dept. of St

NOTIFY: 



UNCLASSIFIED

6

UNCLASSIFIED

PAGE 04 STATE 296862

> JOHNSON, GARY AGE 18

[Redacted]

b6 Per Dept.

23. WADE, ROBERTA NEE: HUSKIN AGE 67

NOTIFY:

[Redacted]

[Redacted]

7

~~CONFIDENTIAL~~

FBB437

23 Nov 78 17 28z

PAGE 01 STATE 296714
ORIGIN ARA-15

FEDERAL BUREAU
OF INVESTIGATION
COMMUNICATIONS SECTION

Assoc. Dir.	_____
Dep. AD Adm.	_____
Dep. AD Inv.	_____
Asst. Dir.:	_____
Adm. Serv.	_____
Crim. Inv.	MRS
Ident.	_____
Insp.	_____
Laboratory	_____
Legal Coun.	_____
Plan. & Insp.	_____
Rec. Mgnt.	_____
Tech. Servs.	_____
Training	_____
Public Affs. Off.	_____
Telephone Rm.	_____
Director's Sec'y	_____

INFO OCT-01 EUR-12 ISO-00 NEA-11 SSO-00 FBIE-00 CIAE-00
 DODE-00 PA-01 TRSE-00 SCS-06 MCT-02 CA-01 INR-10
 INRE-00 SY-05 SYE-00 USSS-00 H-01 AID-05 SS-15
 L-03 NSCE-00 CCO-00 OC-06 JUSE-00 NSAE-00 ICAE-00
 CG-00 DOTE-00 SVC-00 /094 R

b6 per F
b7C

FEDERAL GOVERNMENT

DRAFTED BY ARA [redacted]

APPROVED BY ARA [redacted]

S/S-O [redacted]

b6 per FBI
b7C

Rymer

MRS

-----040560 231707Z /41

O 231641Z NOV 78

FM SECSTATE WASHDC

TO AMEMBASSY GEORGETOWN IMMEDIATE

AMEMBASSY PANAMA IMMEDIATE

AMEMBASSY CARACAS IMMEDIATE

AMEMBASSY PORT OF SPAIN IMMEDIATE

AMEMBASSY LONDON IMMEDIATE

AMEMBASSY PARAMARIBO IMMEDIATE

CINCSOUTHCOM QUARRY HTS CZ IMMEDIATE

CINCMAC SCOTT AFB IL IMMEDIATE

USREDCOM/RCJ2 MACDILL AFB FL IMMEDIATE

USCINCARRED FT MCPHERSON GA IMMEDIATE

CDR 18TH AIRBORNE CORPS FT BRAGG NC IMMEDIATE

USCINCEUR VIRGEN GE/2 IMMEDIATE

FBI
ALL INFORMATION CONTAINED
HEREIN IS UNCLASSIFIED
DATE 9/17/90 BY 1048 DCM/ubm

89-4286-78

NOV 24 1978

Declass per State let 2/16/2005
UC65179DMH/ST/bpg

58 NOV 28 1978

~~CONFIDENTIAL~~ STATE 296714

LONDON FOR MICHAEL FINLEY

E.O. 11652: GDS

TAGS: CASC, CREP (RYAN, LEO), GY

SUBJECT: SITUATION REPORT NO. 16

~~CONFIDENTIAL~~

2

~~CONFIDENTIAL~~

PAGE 02

STATE 296714

REFERENCE: STATE 296525 AND PREVIOUS

1. THE FIRST C-141 CARRYING THE REMAINS OF FORTY VICTIMS OF THE JONESTOWN TRAGEDY ARRIVED AT DOVER AIR FORCE BASE AT 0600 EST. THIRTY-SEVEN BODIES ARE UNIDENTIFIED; OF THE THREE OTHERS, ONE IS THAT OF THE REV. JONES' ADOPTED SON, JIMMY.

2. REMOVAL OF DEAD FROM JONESTOWN TO GEORGETOWN BEGAN AGAIN THIS MORNING AT 0600 EST. THE NINE HELICOPTER SORTIES SCHEDULED FOR TODAY ARE EXPECTED TO BRING 162 BODIES TO GEORGETOWN. THE NEXT FLIGHT TO DOVER CARRYING EIGHTY BODIES IS SCHEDULED TO DEPART GEORGETOWN AT 1500 EST. THE COMMANDER OF THE US TASK FORCE IN GUYANA HAS INDICATED THE OPERATION WILL BE COMPLETED TOMORROW, NOVEMBER 24.

3. ONE HUNDRED AND SIXTY SEVEN TRANSFER CASES ARE IN GEORGETOWN; 138 MORE WILL ARRIVE TODAY. THE REMAINDER NEEDED WILL BE RETURNED FROM DOVER AND REUSED.

3

4. NO FURTHER ATTEMPTS TO IDENTIFY BODIES ARE BEING MADE IN GUYANA. AN SCS REPRESENTATIVE AND AN FBI DISASTER SQUAD ARE IN DOVER TO AID MILITARY PERSONNEL IN THE IDENTIFICATION PROCESS. IN INSPECTING THE JONESTOWN SETTLEMENT, AN EMBASSY CONSULAR OFFICER COUNTED ONLY 600 SINGLE BEDS, AN INDICATION THAT EARLIER ESTIMATES OF A THOUSAND OR MORE RESIDENTS OF JONESTOWN WERE PROBABLY EXAGGERATED.

5. THE EMBASSY REPORTS THAT SOME OF THE SURVIVORS IN GEORGETOWN ARE BEGINNING TO AGITATE FOR RETURN TO THE U.S. HOWEVER, GUYANESE AUTHORITIES APPARENTLY WILL NOT BE PREPARED TO PERMIT ANY DEPARTURES UNTIL TOMORROW, NOVEMBER 24 AT THE EARLIEST.

~~CONFIDENTIAL~~

~~CONFIDENTIAL~~

PAGE 03

STATE 296714

6. IT IS EXPECTED THE SURVIVORS WILL PROBABLY BE RELEASED
IN TWO GROUPS. THE FIRST WILL BE COMPOSED OF 24 BEGIN
QUOTE NON-PROBLEM END QUOTE REFUGEES PLUS SOME VERY ELDER-
LY MEMBERS OF THE SECOND GROUP. THIS SECOND GROUP IS MADE
UP OF PEOPLES' TEMPLE MEMBERS STILL UNDER INVESTIGATION BY
THE GOG. VANCE

5

UNCLASSIFIED

FBB474

Assoc. Dir.	_____
Dep. AD Adm.	_____
Dep. AD Inv.	_____
Asst. Dir.:	
Adm. Serv.	_____
Crim. Inv.	_____
Ident.	_____
Intell.	_____
Laboratory	_____
Legal Coun.	_____
Plan. & Insp.	_____
Rec. Mgmt.	_____
Tech. Servs.	_____
Training	_____
Public Affs. Off.	_____
Telephone Rm.	_____
Director's Sec'y	_____

PAGE 01

STATE 23 Nov 78 22 47z
296909

ORIGIN L-03

RECEIVED
FEDERAL BUREAU
OF INVESTIGATION
COMMUNICATIONS SECTION

INFO OCT-01 ARA-15 ISO-00 CA-01 JUSE-00 SCS-06 SSO-00
 NSCE-00 INRE-00 SS-15 DODE-00 FBIE-00 H-02 SY-05
 CIAE-00 INR-10 NSAE-00 /058 R

ALL INFORMATION CONTAINED
HEREIN IS UNCLASSIFIED
DATE 9/17/97 BY 1048 D/S/ML

DRAFTED BY L/ARA: MKOZAK/SD

FEDERAL GOVERNMENT

APPROVED BY ARA: JBUCKNELL

L:MR. FEDLMAN (DRAFT)

CA:AAGISE (DRAFT)

L/CA:MR. DALTON (PHONE)
S/S-O:TGMARTIN

Rymur

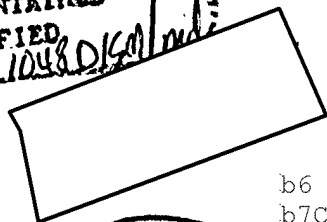

b6 per FB
b7C

WDS

-----044331 232237Z /61

O 232212Z NOV 78 ZFF4

FM SECSTATE WASHDC

TO AMEMBASSY GEORGETOWN NIACT IMMEDIATE

REC-1241

89-4286-79

NOV 24 1978

UNCLAS STATE 296909

E.O. 11652: N/A

TAGS: CASC, CDES

SUBJECT: PROPERTY OF DECEASED AMCITS

58 NOV 28 1978

REF: A) STATE 296852 B) DALTON/DIKEOS TELCON 11/22/78

SLA

1. REF A AUTHORIZED YOU TO RETAIN LOCAL LEGAL COUNSEL FOR PURPOSE OF OBTAINING PRELIMINARY ADVICE AS TO POTENTIAL ISSUES CONCERNING PROPERTY OF DECEASED AMCITS ASSOCIATED WITH PEOPLES TEMPLE. THIS MESSAGE SETS FORTH MORE DETAILED GUIDANCE IN THIS CONNECTION.

2. AS YOU KNOW, DEPT HAS STATUTORY OBLIGATION TO MAKE ALL EFFORTS TO OBTAIN CUSTODY OF PERSONAL ESTATES OF AMCITS WHO DIE OVERSEAS. WE DO NOT HAVE SUCH RESPONSIBILITY WITH RESPECT TO PROPERTY OF ORGANIZATION SUCH AS PEOPLES TEMPLE.

UNCLASSIFIED

2

UNCLASSIFIED

PAGE 02

STATE 296909

WE ASSUME THAT ULTIMATE ISSUE ON WHICH YOU REQUIRE ADVICE IS QUESTION OF DETERMINING STATUS UNDER LOCAL LAW OF VARIOUS ITEMS OF PROPERTY FOUND IN GUYANA I.E. WHICH IS PROPERTY OF INDIVIDUAL AMCITS AND WHICH IS PROPERTY OF ORGANIZATION. FROM THIS STANDPOINT, RETENTION OF LOCAL COUNSEL WOULD APPEAR USEFUL ALTHOUGH U.S. LAW WILL ALSO UNDOUBTEDLY BE RELEVANT TO QUESTION OF STATUS OF PROPERTY, AND WE WILL WISH TO MAINTAIN CLOSE COORDINATION BETWEEN YOUR EFFORTS AND OUR OWN IN THIS REGARD. PLEASE ADVISE US SOONEST RE NATURE ISSUES UNDER LOCAL LAW WHICH SEEM RELEVANT TO QUESTION OF STATUS OF PROPERTY (E.G. WHAT IS STATUS OF PT IN GUYANA, A U.S/ OR GUYANA CORPORATION?), AS WELL AS ANY OTHER AREAS IN WHICH YOU BELIEVE LOCAL COUNSEL COULD BE USEFUL.

3. PER REF B, WE UNDERSTAND THAT AMOUNT OF PROPERTY AT JONESTOWN AS REPORTED BY MEDIA MAY BE GROSSLY EXAGGERATED. ONE IMMEDIATE CONCERN SHOULD BE TO ASSURE THAT US CONSULAR OFFICERS PREPARE A FULL ACCOUNTING OF ALL MOVEABLE PROPERTY FOUND IN THE AREA TO AVOID ANY POTENTIAL CLAIMS BY RELATIVES, ETC. THAT PROPERTY WAS DIVERTED BY COG OR INDIVIDUALS.

3

YOU SHOULD ALSO PROMPTLY ADVISE GOG OF DEPT'S
STATUTORY RESPONSIBILITY TO TAKE CUSTODY OF ALL
SUBSTANTIAL ASSETS OF DECEASED AMERICANS, AND REQUEST
THAT THEY TURN OVER TO YOU IMMEDIATELY ALL PROPERTY
IDENTIFIABLE AS SUCH (OBVIOUSLY ITEMS WHICH GOG MAY
REQUIRE AS EVIDENCE IN LEGAL PROCEEDINGS AGAINST PEOPLES
TEMPLE MEMBERS SHOULD BE LEFT IN GOG CUSTODY PENDING
COMPLETION OF PROCEEDINGS). THIS SHOULD ASSIST IN
DETERMINING EXTENT OF LOCAL LEGAL ISSUES INVOLVED ; (IF
GOG PREPARED TO TURN OVER BULK OF PROPERTY FOUND

UNCLASSIFIED

4

UNCLASSIFIED

PAGE 03

STATE 296909

PROBLEM WOULD BECOME ONE OF DETERMINING DISTRIBUTION UNDER US LAW. IF GOG SHOULD ASSERT CUSTODY ON GROUNDS THAT PROPERTY IS NOT THAT OF INDIVIDUALS, GUYANA LAW AS WELL AS US WILL BECOME RELEVANT).

5. WITH RESPECT TO RETAINING LEGAL COUNSEL, YOU SHOULD BE AWARE THAT ATTORNEYS' S COMMONLY BILL FOR ADVICE ON ESTIMATE MATTERS ON BASIS OF A PERCENTAGE OF THE ESTATE VALUE. WE WOULD NOT WISH ANY MISUNDERSTANDING TO DEVELOP IN THIS RESPECT, AND YOU SHOULD THEREFORE ADVISE LOCAL COUNSEL THAT HE WOULD BE RETAINED ON FIXED FEE BASIS. WE WOULD BE PREPARED INITIALLY TO SEEK UP TO DOLS 1000 FOR THIS PURPOSE, AND WOULD CONSIDER SEEKING ADDITIONAL FUNDING IF MORE EXTENSIVE SERVICES SUBSEQUENTLY APPEAR TO BE REQUIRED. CHRISTOPHER

5

LIMITED OFFICIAL USE

FBB452

Asst. Dir.:	
Dep. AD Adm.	
Dep. AD Inv.	
Asst. Dir.:	
Adm. Serv.	
Crim. Inv.	
Ident.	
Intell.	
Lab.	
Legal Coun.	
Plan. & Insp.	
Rec. Mgmt.	
Tech. Servs.	
Training	
Public Affs. Off.	
Telephone Rm.	
Director's Sec'y	

PAGE 01 STATE 296852 NOV 78 22 11z

ORIGIN ARA-15

RECEIVED *TR*
 FEDERAL BUREAU
 OF INVESTIGATION
 COMMUNICATIONS SECTION

INFO OCT-01 ISO-00 L-03 SSO-00 SCS-06 CA-01 SS-15
 DODE-00 FBIE-00 JUSE-00 SY-05 H-01 CIAE-00 INR-10
 NSAE-00 NSCE-00 INRE-00 /057 R

DRAFTED BY ARA:WDCALDERHEAD

APPROVED BY ARA:JBUSHNELL

ARA:RZIMMERMANN

S/S-O:RCASTRODALE

L/HANSELL

FBI
 ALL INFORMATION CONTAINED
 HEREIN IS UNCLASSIFIED
 DATE *9/17/92* BY *1048 pka/uda*

FEDERAL GOVERNMENT

Rymur

b6 per F
b7C

-----043502 232108Z /64

O 231941Z NOV 78

FM SECSTATE WASHDC

TO AMEMBASSY GEORGETOWN IMMEDIATE

REC-124

89-4286-80

22 NOV 24 1978

LIMITED OFFICIAL USE STATE 296852

E.O. 11652: N/A

211
 58 NOV 28 1978
 TAGS: AFSP, GY

SUBJECT: EMBASSY LEGAL SERVICES - PEOPLES' TEMPLE

REFERENCE: BURKE/BUSHNELL TELECON OF NOV. 22

EMBASSY AUTHORIZED TO ENGAGE IMMEDIATELY LEGAL COUNSEL
ESSENTIAL TO PROVIDE STATUTORY PROTECTIVE SERVICES TO
AMERICAN CITIZENS INVOLVED IN PEOPLES' TEMPLE CRISIS. BE-
FORE SIGNING FORMAL CONTRACT, REQUEST TEXT DESCRIBING SCOPE
OF SERVICES AND ESTABLISHING FEES BE PASSED TO DEPARTMENT
FOR CLEARANCE. CHARGE EVENTUAL COSTS TO REGULAR PROGRAM
FUNDS. KEEP TRACK OF EXPENDITURES FOR INCLUSION NEXT
ALLOTMENT ADJUSTMENT REQUEST FOR FUNDS.

YOU SHOULD PURSUE LEGAL PROCEDURES TO ASSURE PROPERTY,

LIMITED OFFICIAL USE

2

LIMITED OFFICIAL USE

PAGE 02

STATE 296852

BOTH MOVEABLES AND IMMOVEABLES IS HANDLED IN ACCORDANCE WITH LAWS OF GUYANA AND, AS APPROPRIATE, US LAWS AND REGULATIONS. WE ARE AWARE THAT ELEMENTS OF PROPERTY MAY BE INVOLVED IN INVESTIGATIONS NOW GOING ON. WHILE WE WOULD, OF COURSE, BE PREPARED TO TRANSPORT VALUABLES TO US BY AF LIFTS NOW AVAILABLE, SUCH TRANSPORT SHOULD BE DONE ONLY WITH FULL AGREEMENT OF GOG OFFICIAL. LEGAL/COUNSEL TO BE RETAINED AS INDICATED ABOVE CAN ADVISE YOU.

DEPUTY SECRETARY AND LEGAL ADVISER HAVE REVIEWED SUBSTANCE OF THIS MESSAGE AND IT SUPERSEDES ANY PRIOR INSTRUCTIONS. ADDITIONAL TECHNICAL GUIDANCE FROM L ON GENERAL ISSUES INVOLVED WILL BE SENT AS SOON AS POSSIBLE.

FROM BUSHNELL: -- GIVEN URGENCY SITUATION PROCEED TO ACQUIRE LEGAL SERVICES SOONEST WITH FORMAL ARRANGEMENTS TO FOLLOW AS INDICATED ABOVE. CHRISTOPHER

3

UNCLASSIFIED

FBB365

Assoc. Dir.	_____
Dep. AD Adm.	_____
Dep. AD Inv.	_____
Asst. Dir.:	_____
Adm. Serv.	_____
Crim. Inv.	175
Ident.	_____
Intell.	_____
Laboratory	_____
Legal Coun.	_____
Plan. & Insp.	_____
Rec. Mgnt.	_____
Tech. Servs.	_____
Training	_____
Pub. Affs. Off.	_____
Talent Dev. Rm.	_____
Director's Sec'y	_____

PAGE 01

STATE 296181

23 Nov 78 03 41z

ORIGIN SCS-06

RECEIVED
FEDERAL BUREAU
OF INVESTIGATION
COMMUNICATIONS SECTION

INFO OCT-01 ARA-15 ISO-00 ABF-01 FSE-00 L-03 CA-01

FBIE-00 SSO-00 /027 R

ALL INFORMATION CONTAINED
HEREIN IS UNCLASSIFIED
DATE 9/17/92 BY 1048 DKM

b6 per FBI
b7C

DRAFTED BY CA/SCS/ RAMCKENZIE:DG

APPROVED BY ARA/JBUSHNELL

BF/OF/JMARABLE (INFO)

L/CA/DALTON(SUBSTANCE)

FEDERAL GOVERNMENT

CA/SCS/AAGISE

S/S-O:TMARTIN

Rymur

REC-12079 -4286-81

DESIRED DISTRIBUTION

CA/SCS

NOV 24 1978

-----028024 230207Z /75-----

O 230057Z NOV 78

FM SECSTATE WASHDC

TO AMEMBASSY GEORGETOWN IMMEDIATE

UNCLAS STATE 296181

SMA

58 NOV 28 1978

E.O. 11652:N/A

TAGS:CARR

SUBJECT: JONESTOWN SURVIVORS

1. JONESTOWN SURVIVORS WHO ARRIVE GEORGETOWN WILL BE CONSIDERED UNDER TEMPORARY DETENTION BY GUYANA AUTHORITIES AND WOULD QUALIFY FOR FINANCIAL ASSISTANCE UNDER EMDAP PER A-0272 OF JANUARY 27, 1978.

2. THEREFORE SUBSISTENCE PREVIOUSLY AUTHORIZED BY PHONE (MCKENZIE - WARD) UNDER REPATRIATION PROGRAM WILL NOT REPEAT NOT BE APPLICABLE AND SUBSISTENCE EXPENDITURES SHOULD NOT REPEAT NOT BE CHANGED TO ALLOTMENT 9K4024-1 APPROPRIATION 1990522.

UNCLASSIFIED

2

UNCLASSIFIED

PAGE 02

STATE 296181

3. EMBASSY AUTHORIZED HERewith TO EXPEND NECESSARY FUNDS
UNDER SHORT-TERM FULL DIET ELEMENT OF EMDAP. CHANGE
EXPENDITURES TO APPROPRIATION 1990113; ALLOTMENT 2023;
OBLIGATION 99999001; OBJECT 3320; AMOUNT 5,000 DOLLARS
IF ADDITIONAL FUNDS REQUIRED ADVISE. VANCE

3

UNCLASSIFIED

FBB455

Assoc. Dir.	_____
Dep. AD Adm.	_____
Dep. AD Inv.	_____
Asst. Dir.:	
Adm. Serv.	_____
Crim. Inv.	_____
Ident.	_____
Insp.	_____
Laboratory	_____
Legal Coun.	_____
Plan. & Insp.	_____
Rec. Mgmt.	_____
Tech. Servs.	_____
Training	_____
Public Affs. Off.	_____
Telephone Rm.	_____
Director's Sec'y	_____

PAGE 01 STATE 296856 78 22 10z

ORIGIN SCS-06

FEDERAL BUREAU OF INVESTIGATION COMMUNICATIONS SECTION

INFO OCT-01 ARA-15 ISO-00 CA-01 SIG-03 DODE-00 PM-05

FBIE-00 CIAE-00 INR-10 NSAE-00 PA-02 TRSE-00

MCT-02 INRE-00 SY-05 USSS-00 H-02 AID-05 SS-15

SSO-00 NSCE-00 CCO-00 OC-06 JUSE-00 ICAE-00 CG-00

L-03 DOTE-00 /081 R

FEDERAL GOVERNMENT ALL INFORMATION CONTAINED HEREIN IS UNCLASSIFIED DATE 9/17/92 BY 1047 OKM

b6 per F b7C

DRAFTED BY CA/SCS(JDIETERICH:ACM)

APPROVED BY ARA:JBUSHNELL

S/S-0: RCASTRODALE

Rymur

-----043709 232121Z /64

O 232043Z NOV 78

FM SECSTATE WASHDC

TO AMEMBASSY GEORGETOWN IMMEDIATE

UNCLAS 89-4286-82

NOV 24 1978

UNCLAS STATE 296856

E.O. 11652: N/A

58 NOV 28 1978

TAGS: CASC

ADG

SUBJECT: PRESS GUIDANCE

Q. TO WHAT EXTENT ARE US MILITARY FORCES INVOLVED IN SEARCH EFFORTS IN GUYANA?

A. ALTHOUGH ACTUAL GROUND SEARCH EFFORTS IN THE JONES-TOWN AREA ARE THE RESPONSIBILITY OF THE GUYANESE POLICE AND MILITARY. THE US MILITARY IS PROVIDING ANY SUPPORT THEY REQUIRE. IN PARTICULAR, WE HAVE MADE AVAILABLE HELICOPTERS INCLUDING ONE WITH LOUDSPEAKERS. WE HAVE ALSO FURNISHED WALKIE TALKIES AND OTHER SUPPLIES.

Q. WHY AREN'T U.S. FORCES BEING USED FOR GROUND SEARCH?

UNCLASSIFIED

2

UNCLASSIFIED

PAGE 02

STATE 296856

A. BOTH THE US GOVERNMENT AND THE GUYANESE GOVERNMENT AGREE THAT SEARCHING IN THE JUNGLE AROUND JONESTOWN CAN BEST BE HANDLED BY THOSE LOCAL FORCES FAMILIAR WITH THE AREA AND THE PREVAILING JUNGLE CONDITIONS. BOTH ALSO AGREE THAT US MILITARY FORCES CAN BE USED MOST EFFICIENTLY IN AIR SEARCH AND SUPPLY ACTIVITIES AS WELL AS IN THE TRANSPORTATION OF THE DECEASED FROM GUYANA TO THE U.S.

Q. WHAT IS THE COST TO THE US GOVERNMENT OF ALL THESE OPERATIONS RELATED TO THE JONESTOWN TRAGEDY?

A. THESE ARE OBVIOUSLY VERY COMPLEX OPERATIONS INVOLVING VARIOUS DEPARTMENTS OF THE US GOVERNMENT AND MANY SUBDIVISIONS WITHIN THOSE DEPARTMENTS. AT ANY RATE IT IS VERY DIFFICULT TO COME UP WITH A DEFINITIVE COST SINCE MANY ELEMENTS INVOLVED ARE IN FACT ONGOING ACTIVITIES WHICH ARE ALREADY FUNDED. IT WILL TAKE TIME TO DEFINE AND IDENTIFY WHICH PARTS OF THOSE ACTIVITIES ARE SPECIFICALLY ATTRIBUTABLE TO THE GUYANA SITUATION.

3

Q. DO YOU HAVE ANY INFORMATION ABOUT THE RETURN OF
SURVIVORS TO THE US?

A. IT IS OUR UNDERSTANDING THAT MOST, IF NOT ALL, OF
THE SURVIVORS, EXCEPT THOSE AGAINST WHOM THERE ARE
GUYANESE LEGAL CHARGES PENDING, WILL BE RETURNING TO THE
US. HOWEVER, I HAVE NO SPECIFICS FOR YOU AT THIS TIME.

CHRISTOPHER

UNCLASSIFIED

4

~~CONFIDENTIAL~~

FBB371

Assoc. Dir.	_____
Dep. AD Adm.	_____
Dep. AD Inv.	_____
Asst. Dir.:	
Adm. Serv.	_____
Crim. Inv.	_____
Ident.	_____
Int'l.	_____
Laboratory	_____
Legal Coun.	_____
Plan. & Insp.	_____
Rec. Mgnt.	_____
Tech. Servs.	_____
Training	_____
Public Affs. Off.	_____
Telephone Rm.	_____
Director's Sec'y	_____

PAGE 01

STATE 296179

23 Nov 78 03 03z

ORIGIN ARA-15

FEDERAL BUREAU OF INVESTIGATION COMMUNICATIONS SECTION

INFO OCT-01 SCS-06 ISO-00 SSO-00 CA-01 FBIE-00 CIAE-00

PA-01 TRSE-00 INR-10 INRE-00 SY-05 SYE-00 USSS-00

H-01 AID-05 SS-15 NSCE-00 CCO-00 OC-06 JUSE-00

NSAE-00 ICAE-00 AS-02 CG-00 L-03 DOTE-00 /071 R

FEDERAL GOVERNMENT

DRAFTED BY ARA [redacted] JE

APPROVED BY ARA [redacted]

CA/SCS:AGISE

S/S-0:T [redacted]

CA/SCS [redacted]

b6 per FBI
b7C

ALL INFORMATION CONTAINED
HEREIN IS UNCLASSIFIED
DATE 9/17/92 BY 1098 DEM/wdh

Rymur

[redacted box]
Wes

b6 per F
b7C

-----029165 230249Z 175

O 230055Z NOV 78

FM SECSTATE WASHDC

TO SECDEF WASHDC IMMEDIATE 2070

JCS WASHDC IMMEDIATE 1678

INFO AMEMBASSY GEORGETOWN IMMEDIATE

FBI WASHDC IMMEDIATE 0040

CINCMAC IMMEDIATE

USCINCSOUTH QUARRY HTS CZ IMMEDIATE

HEW WASHDC IMMEDIATE

REC-807-4286-84

NOV 24 1978

Declass per State let 2/16/2005
UC65179DMH/ST/bpg

58 NOV 28 1978

~~CONFIDENTIAL~~ STATE 296179

E.O. 11652: N/A

TAGS: CASC, OREP (RYAN, LEO), GY

SUBJECT: TRANSPORTATION OF JONESTOWN SURVIVORS

REF: (A) STATE 295410, (DTG 220524Z NOV)

1. REF A ALERTED JCS OF THE POSSIBLE NEED FOR THE USE OF MILITARY AIRCRAFT TO TRANSPORT JONESTOWN SURVIVORS FROM GEORGETOWN, GUYANA, TO THE UNITED STATES.

2. AT THE PRESENT TIME 68 SURVIVORS ARE IN GEORGETOWN AND MAY DESIRE TO BE TRANSPORTED TO THE UNITED STATES. REQUEST

~~CONFIDENTIAL~~

2

~~CONFIDENTIAL~~

PAGE 02

STATE 296179

DOD PROVIDE AIR TRANSPORTATION FOR THESE SURVIVORS FROM GEORGETOWN TO CHARLESTON AFB, SOUTH CAROLINA.

3. DUE TO PERSONAL SECURITY CONCERNS EXPRESSED BY SOME SURVIVORS AS IDENTIFIED BY EMB GEORGETOWN, IT MAY BE NECESSARY TO SEGREGATE THESE SURVIVORS INTO TWO CATEGORIES FOR TRAVEL PURPOSES. CATEGORIES ARE AS FOLLOWS:

(A) "LAMAR", APPROXIMATELY 44 PERSONS

(B) "EVE/LEARY", APPROXIMATELY 24 PERSONS

GROUP B HAS EXPRESSED PERSONAL SECURITY CONCERNS.

4. EMBASSY GEORGETOWN WILL ASSUME RESPONSIBILITY FOR IDENTIFYING AND CATEGORIZING INTO APPROPRIATE GROUPS THE SURVIVORS FOR EMBARKATION ON US MILITARY AIRCRAFT, AND WILL ADVISE WHEN ALL SURVIVORS ARE READY FOR MOVEMENT FROM GEORGETOWN. IT IS ANTICIPATED THAT PAX WILL NOT BE READY FOR MOVEMENT EARLIER THAN 25 NOV.

3

5. DOD WILL BE RESPONSIBLE FOR TRANSPORTATION OF SUR-
VIVORS ONLY. SURVIVORS WILL BE MET AT DESTINATION BY
REPRESENTATIVES FROM HEW AND FBI, WHO WILL ASSUME
RESPONSIBILITY FOR FURTHER PROCESSING AND ONWARD MOVEMENT
OF SURVIVORS.

6. AUTHORIZATION IS GRANTED FOR US MILITARY TO CONDUCT
SEARCH OF SURVIVORS AND THEIR PERSONAL POSSESSIONS FOR
WEAPONS/CONTRABAND PRIOR TO EMBARKATION ON US MILITARY
AIRCRAFT.

7. IN VIEW OF SEARCH OPERATIONS IN PROGRESS, IT IS
POSSIBLE THAT ADDITIONAL SURVIVORS WILL BE FOUND AND

~~CONFIDENTIAL~~

~~CONFIDENTIAL~~

PAGE 03

STATE 296179

REQUIRE CHANGES IN NUMBERS ABOVE. POTENTIALLY, FURTHER
FLIGHTS MAY BE REQUIRED. VANCE

5

LIMITED OFFICIAL USE

384 73

Assoc. Dir.	
Dep. AD Adm.	
Dep. AD Inv.	
Asst. Dir.:	
Adm. Serv.	
Crim. Inv.	<i>MRS</i>
Ident.	
Intell.	
Laboratory	
Legal Coun.	
Plan. & Insp.	
Rec. Mgmt.	
Tech. Servs.	
Training	
Public Affs. Off.	
Telephone Rm.	
Director's Sec'y	

PAGE 01

STATE 296908 48z
23 NOV 78

ORIGIN ARA-15

RECEIVED
FEDERAL BUREAU
OF INVESTIGATION
COMMUNICATIONS SECTION

INFO OCT-01 ISO-00 FBIE-00 SS-15 SCS-06 CA-01 H-01

CIAE-00 INR-10 NSAE-00 JUSE-00 SY-05 SSO-00

INRE-00 SYE-00 DODE-00 /054 R *FBY*

ALL INFORMATION CONTAINED
HEREIN IS UNCLASSIFIED
DATE 9/17/92 BY 1046 DCU/MLH

DRAFTED BY ARA/RPP:RZIMMERMANN

FEDERAL GOVERNMENT

APPROVED BY ARA:JBUSHNELL

FBI:ANICHOLAS

S/S-O: TGMARTIN

SCS:RDAVIS

RYMUR

res

b6
b7c

-----044304 232225Z /64

O 232212Z NOV 78 ZFF4

FM SECSTATE WASHDC

TO AMEMBASSY PORT OF SPAIN NIREG-130 IMMEDIATE

AMEMBASSY BRIDGETOWN NIACT IMMEDIATE

INFO AMEMBASSY GEORGETOWN IMMEDIATE

89-4286-81mk/kune

NOV 24 1978

LIMITED OFFICIAL USE STATE 296908

BRIDGETOWN FOR AMB. FOX

58 NOV 28 1978
E.O. 11652: N/A

This was read to Kune - State Dept. as he was not aware of same.
11/27/78 7pm JCC

ADS

TAGS: FY, TD, ASEC, 30

SUBJECT: MEMBERS OF PEOPLES TEMPLE IN PORT OF SPAIN

REFERENCE: PORT OF SPAIN 3373

1. FBI NOT PREPARED TO FINANCE TRIP BY ANY OF THE PEOPLES TEMPLE MEMBERS CURRENTLY IN PORT OF SPAIN, BUT WE ARE STILL VERY INTERESTED IN RECEIVING GOTT AGREEMENT FOR FBI TO GO TO TRINIDAD AND TOBAGO TO INTERVIEW THEM.

2. IF THE THREE AMERICANS ARE DESTITUTE EMBASSY MAY WISH

LIMITED OFFICIAL USE

2

LIMITED OFFICIAL USE

PAGE 02

STATE 296908

TO CONSIDER REPATRIATION. CHRISTOPHER

3

~~CONFIDENTIAL~~

FBB497

24 Nov 78 09 27z

PAGE 01 STATE 297279
ORIGIN ARA-15

RECEIVED
FEDERAL BUREAU
OF INVESTIGATION
COMMUNICATIONS SECTION

Assoc. Dir.	_____
Dep. AD Adm.	_____
Dep. AD Inv.	_____
Asst. Dir.:	_____
Adm. Serv.	_____
Crim. Inv.	_____
Ident.	_____
Intell.	_____
Laboratory	_____
Legal Coun.	_____
Plan. & Insp.	_____
Rec. Mgmt.	_____
Tech. Servs.	_____
Training	_____
Public Affs. Off.	_____
Telephone Rm.	_____
Director's Sec'y	_____

INFO OCT-01 ISO-00 H-01 SS-15 SY-05 INR-10 CA-01

MCT-02 SCS-06 PA-01 AID-05 OC-06 CCO-00 SSO-00

SYE-00 NSCE-00 USSS-00 INRE-00 TRSE-00 CIAE-00

NSAE-00 FBIE-00 JUSE-00 /068 R

ALL INFORMATION CONTAINED
HEREIN IS UNCLASSIFIED
DATE 7/17/92 BY 1049 OKM/ukm

DRAFTED BY ARA/RPP: [redacted] FEDERAL GOVERNMENT

APPROVED BY ARA [redacted]

DOD:CDR [redacted]

S/S-O: [redacted]

b6 per FBI
b7C

RYMUR

REC-130

89-4286-88

-----049990 240912Z /21

O 240835Z NOV 78

FM SECSTATE WASHDC

TO AMEMBASSY GEORGETOWN IMMEDIATE

INFO SECDEF WASHDC IMMEDIATE 2096

JCS WASHDC IMMEDIATE 1693

CINCMAC SCOTT AFB ILL IMMEDIATE

USCINCSOUTH QUARRY HTS CA IMMEDIATE

FBI WASHDC IMMEDIATE 0041

HEW WASHDC IMMEDIATE

22 NOV 24 1978

Declass per State let 2/16/2005
UC65179DMH/ST/bpg

58 NOV 28 1978

~~CONFIDENTIAL~~ STATE 297279

E.O. 1.1652:GDS

TAGS: CASC, GY

SUBJECT: TRANSPORT OF SURVIVORS

REF: STATE 296179; JCS 231405Z

1. HEW HAS INITIATED PREPARATIONS TO RECEIVE SURVIVORS AND HAS ASKED FOR MINIMUM OF 24 HOURS NOTICE BEFORE ARRIVAL CONUS.

2. HEW WILL NEED AT TIME OF NOTICE SPECIFIC DESTINATION OF

~~CONFIDENTIAL~~

2

~~CONFIDENTIAL~~

PAGE 02

STATE 297279

EACH INDIVIDUAL, FULL NAME, DATE AND PLACE OF BIRTH, SOCIAL SECURITY NUMBER, AND NAME, ADDRESS, PHONE OF NOK IN US OR INDIVIDUALS THAT MIGHT BE CONTACTED FOR ASSISTANCE.

3. MILITARY NOW PLANNING ON TWO LIFTS FOR THESE SURVIVORS, ONE FOR EVE/LEARY GROUP AND ONE FOR LAMAR GROUP.

4. CHARLESTON HAS BEEN DESIGNATED AS PORT OF ENTRY BUT THIS INFORMATION IS NOT REPEAT NOT BEING MADE PUBLIC AT THIS TIME. CHRISTOPHER

3

SFO 5762315323

PR HQ LA

DE SF 001

P 232304Z NOV 78

FM SAN FRANCISCO (9-3277) (P) (SQUAD 10)

TO DIRECTOR, FBI

IMMEDIATE

LOS ANGELES

IMMEDIATE

BT

UNCLAS E F T O

Guyana
ca

UNSUB; PEOPLE'S TEMPLE OF THE DISCIPLES OF CHRIST; JAMES JONES, AKA, JIM JONES, TEMPLE LEADER; INFORMATION CONCERNING.

RE SAN FRANCISCO TELCALLS TO BUREAU NOVEMBER 19, 1978.

PEOPLE'S TEMPLE (PT) AND FOUNDER JIM JONES DURING RECENT *CHRISTIAN Church, DISCIPLES OF CHRIST.*

MONTHS HAS BEEN SUBJECT OF CONSIDERABLE NEWSPAPER PUBLICITY

BECAUSE OF ALLEGATIONS THAT THEY HAVE HELD PT MEMBERS AGAINST

THEIR WILL IN GUYANA. JONES AND IMMEDIATE FOLLOWERS ARE IN **22** NOV 24 1978

GUYANA, HOWEVER, TWO CHURCHES ARE LOCATED IN THE UNITED

STATES, PT LOCATED AT 1859 GEARY BOULEVARD, SAN FRANCISCO, AND

PT LOCATED AT HOOVER AND EL ALVERADO, LOS ANGELES. THE LATTER

TEMPLE IS REPORTEDLY RELATIVELY INACTIVE. ESTIMATED NUMBER OF

ACTIVE MEMBERS OF PT IS 1200 TO 1500 IN GUYANA AND UNITED STATES,

WITH APPROXIMATELY 200 IN UNITED STATES.

TIM STOEN, ATTORNEY, SAN FRANCISCO, WAS ALLEGEDLY

INSTRUMENTAL IN LEADING SMALL GROUP OF DISSIDENTS TO SPLIT WITH

58 NOV 28 1978

19 NOV 78 23 36z

FEDERAL BUREAU OF INVESTIGATION
COMMUNICATIONS SECTION

ALL INFORMATION CONTAINED
HEREIN IS UNCLASSIFIED
DATE 9/17/92 BY 10480

Assoc. Dir.	
Dep. AD Adm.	
Dep. AD Inv.	
Asst. Dir.:	
Adm. Serv.	
Crim. Inv.	
Ident.	
Intell.	
Laboratory	
Legal Coun.	
Plan. & Insp.	
Rec. Mgmt.	
Tech. Servs.	
Training	
Off. of Cong. & Public Affairs	
Director's Sec'y	

Rymur

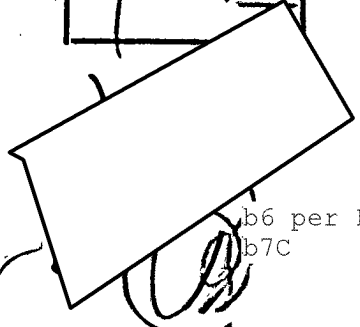

b6 per FB
b7c

GUYANA

REC-102

89-4286-89

ca

ca

u

(4)

PAGE TWO SF 9-3277 UNCLAS E F T O

JONES AND PT. DURING RECENT MONTHS STOEN AND SEVERAL OTHERS HAVE RECEIVED THREATS OF BODILY HARM AND HAVE REPORTED THIS TO SAN FRANCISCO OFFICE AND LOCAL AUTHORITIES. TYPE OF THREATS DID NOT FALL UNDER FEDERAL EXTORTION STATUTE AND WERE BASICALLY THREATS CONVEYED BY ONE OR TWO INDIVIDUALS TO STOEN AND OTHERS THAT AT SOME TIME JONES AND HIS IMMEDIATE FOLLOWERS WOULD RETALIATE AGAINST THE DISSIDENTS FOR LEAVING PT. USA'S OFFICE, SAN FRANCISCO WAS FULLY AWARE OF THE ABOVE AND CONCURRED THAT MATTER SHOULD BE HANDLED BY LOCAL AUTHORITIES. (U)

THE FOLLOWING IS A SUMMARY OF INFORMATION DEVELOPED DURING PAST SEVERAL HOURS FOLLOWING KILLING OF CONGRESSMAN RYAN AND OTHERS IN HIS PARTY IN GUYANA ON NOVEMBER 18, 1978: (U)

[REDACTED] ASSISTANT DISTRICT ATTORNEY (ADA), SAN FRANCISCO COUNTY, DUE TO THREATENED RETALIATION TO BE TAKEN AGAINST DISSIDENT MEMBERS OF PT IMMEDIATELY SET UP COMMAND POST TO COORDINATE EFFORTS OF SAN FRANCISCO POLICE DEPARTMENT AND BERKELEY POLICE DEPARTMENT REGARDING NOTIFICATION OF POSSIBLE VICTIMS. [REDACTED] ESTIMATED THAT DISSIDENT MEMBERS, ESTIMATED TO BE FIFTEEN TO SEVENTEEN RESIDED BERKELEY OR NEARBY EAST BAY AREA, (U)

b6
b7c

PAGE THREE SF 9-3277 UNCLAS E F T O

AND HAVE BEEN CONTACTED BY LOCAL AUTHORITIES. MAJORITY ARE NOW STAYING AT HEADQUARTERS OFFICE OF DISSIDENT GROUP, BERKELEY, TELEPHONE (415) 845-2635 OR (415) 848-1773. DISSIDENT GROUP COMMONLY REFERRED TO HUMAN FREEDOM CENTER AND LOCATED AT 3028 REGENT STREET, BERKELEY, CALIFORNIA. [REDACTED] STATED THAT ARRANGEMENTS ARE BEING MADE FOR OTHER DISSIDENT MEMBERS TO BE MOVED TO SAFE HOUSES AND THAT INASMUCH AS SEVERAL HAVE BEEN LOCATED IN UKIAH, MENDOCINO COUNTY, CALIFORNIA, LOCAL AUTHORITIES THERE WERE NOTIFIED. BERKELEY POLICE DEPARTMENT SWAT TEAM AFFORDING APPROPRIATE PROTECTION AT ABOVE COMMAND POST. PT LOCATED AT 1859 GEARY BOULEVARD, SAN FRANCISCO IS UNDER SURVEILLANCE BY SAN FRANCISCO POLICE DEPARTMENT DUE TO REPORTS THAT A NUMBER OF MEMBERS LOCKED THEMSELVES INSIDE THE TEMPLE AND THAT THEY HAVE A CACHE OF WEAPONS IN THE TEMPLE. CAPTAIN [REDACTED] SAN FRANCISCO POLICE DEPARTMENT (SFPD) IN CHARGE OF SFPD COMMAND POST, TELEPHONE [REDACTED] (u)

USA WILLIAM HUNTER, SAN FRANCISCO, NOVEMBER 19, 1978, ADVISED HE MET WITH TIM STOEN LAST THURSDAY JUST PRIOR TO STOEN'S DEPARTURE WITH CONGRESSMAN RYAN AND GROUP TO GUYANA. HUNTER (u)

b6
b7c

PAGE FOUR SF 9-3277 UNCLAS E F T O

ADVISED THAT STOEN WAS INSTRUMENTAL IN ARRANGING FOR RYAN AND ASSOCIATES TO TRAVEL TO GUYANA TO CHECK ON ACTIVITIES OF PT AND JIM JONES, PARTICULARLY ALLEGATIONS THAT MEMBERS OF PT WERE BEING HELD AGAINST THEIR WILL. (u)

[] ADVISED THAT EARLY AM, NOVEMBER 19, 1978, HE WAS PERSONALLY TELEPHONICALLY CONTACTED BY TIM STOEN WHO WAS CALLING FROM PEGASUS HOTEL, ROOM 403, GEORGETOWN, GUYANA. STOEN STATED THAT HE HAD BEEN WITH CONGRESSMAN RYAN'S GROUP, HOWEVER, HE WAS AMONG TEN INDIVIDUALS THAT STAYED IN GEORGETOWN WHILE RYAN AND OTHERS FLEW TO INTERIOR OF GUYANA TO VISIT PT. STOEN WAS UNABLE TO FURNISH ANY INFORMATION REGARDING KILLING OF RYAN, ET AL, AND WAS EXTREMELY WORRIED THAT HE AND HIS GROUP WERE IN DANGER. STOEN SUBSEQUENTLY TELEPHONICALLY ADVISED [] THAT UNITED STATES EMBASSY HAD SENT AN OFFICIAL TO THE HOTEL AND HE WAS STAYING WITH THEM. STOEN EXPRESSED OPINION THAT DUE TO ACTION IN GUYANA ON NOVEMBER 18, 1978 THAT DISSIDENTS IN GUYANA AND UNITED STATES MAY BE IN DANGER. (u)

b6
b7c

[] SUBSEQUENTLY ADVISED THAT HIS OFFICE JUST RECEIVED INFORMATION FROM SOURCE, FORMER MEMBER PT, THAT JONES HAS

(u)

PAGE FIVE SF 9-3277 UNCLAS E F T O

SUICIDE TYPE GROUP TO CARRY OUT CONTINGENCY PLANS IF HE IS EVER ARRESTED: 1) DISSIDENTS BELIEVED RESPONSIBLE FOR JONES' ARREST WOULD BE KILLED AND 2) TOP UNITED STATES GOVERNMENT OFFICIALS, NOT IDENTIFIED, WOULD BE KIDNAPPED AND HELD HOSTAGE UNTIL JONES WAS RELEASED. (U)

[] ARRANGING FOR INTERVIEW OF SOURCE AND POSSIBLY OTHERS KNOWLEDGEABLE REGARDING ABOVE BY SAN FRANCISCO AGENTS NOVEMBER 19, 1978. (U)

INFORMATION FROM BUREAU REGARDING CLARE JANERO, REPORTED MEMBER OF PT AND MANAGER HAPPY ACRES CARE HOME, REDWOOD VALLEY, CALIFORNIA, REPORTEDLY IN GUYANA, AND STAFF MEMBERS AT HOME MAY BE INVOLVED WITH PT, FURNISHED LOCAL AUTHORITIES. AL AND JEANNIE WILLS, PT DISSIDENTS LOCATED AND ARE STAYING AT DISSIDENT HEADQUARTERS, BERKELEY. (U)

b6
b7c

AGENT [] US SECRET SERVICE (USSS) SAN FRANCISCO, WAS IMMEDIATELY ADVISED AS ABOVE INFORMATION RECEIVED. (U)

CLOSE LIAISON BEING MAINTAINED WITH PERTINENT LAW ENFORCEMENT AGENCIES AND USSS. (U)

5

PAGE SIX SF 9-3277 UNCLAS E F T O

BASED ON INFORMATION REGARDING POSSIBLE KIDNAP-CONSPIRACY
OF UNNAMED UNITED STATES GOVERNMENT OFFICIALS, IMMEDIATE
INTERVIEW WITH SOURCE BEING CONDUCTED TO DETERMINE FULL DETAILS
AND WHETHER INVESTIGATION UNDER CAS-CONSPIRACY STATUTE WARRANTED (u)
BUREAU AND LOS ANGELES WILL BE KEPT ADVISED. (u)

BT

#

6

Assoc. Dir.
 Dep. AD Adm.
 Dep. AD Inv.
 Asst. Dir.:

- Adm. *AM*
- Crim. *W*
- Ident.
- Incl.
- Laboratory
- Legal Coun.
- Plan. & Insp.
- Rec. Mgmt.
- Tech. Serv.
- Training
- Public Affs. Off.
- Telephone Rm.
- Director's Sec'y

19 Nov 78 16 06

Transmit checked by Facsimile - UNCLAS

RECEIVED
 FEDERAL BUREAU
 OF INVESTIGATION
 COMMUNICATIONS SECTION

Precedence IMMEDIATE

To: FBI HEADQUARTERS
ATTN: MRS. MORTIFLORE DIV 6

Date: 11/19/78

From: FBI SAN FRANCISCO 9-3277 (SF)

Time Transmitted: 7:11

Subject: PEOPLE'S TEMPLE OF THE DISCIPLES OF CHRIST
JAMES JONES, aka
Jim Jones, Temple Leader

Initials:

ALL INFORMATION CONTAINED
 HEREIN IS UNCLASSIFIED
 DATE 9/17/92 BY 1048 DKM/ADM

- Fingerprint Photo
- Fingerprint Record
- Map
- Newspaper clipping
- Photograph
- Artists Conception
- Other: Serials from SF file 9-3277

Special handling instructions: (u)

Please deliver immediately to Supervisor

Division 6. (u)
 Mr. attached are the pertinent serials involved in captioned case. (u)

Approved: _____ PCZ

Rymur

89-4286-90

REC-102

22 NOV 24 1978

5- ENCLOSURE

mb

✓ 58 NOV 28 1978

BEST COPY AVAILABLE

PAGE 1

b6
b7c

Memorandum

CHARLES HINER
SUPERVISOR SO 10

DATE: 11/19/78

[redacted]
SPC- 12:00 0:00

SUBJECT:

PEOPLES TEMPLE OF THE DISCIPLES
OF CHRIST
JAMES JONES, aka
Jim Jones,
Temple Leader;

ALL INFORMATION CONTAINED
HEREIN IS UNCLASSIFIED
DATE 9/17/92 BY 1048 OKA/pds

On November 19, 1978, at 12:30 am a Mr. [redacted]
[redacted] who lives at [redacted] Ukiah Ca. 95482,
[redacted] contacted the writer. (u)

Mr. [redacted] advised that the PEOPLES TEMPLE of
Ukiah, Ca. was shipping large crates (supposedly arms)
to Guyana. Mr. [redacted] said that their is evidence to
support his claim that the PEOPLES TEMPLE stores these
large crates in the rear of their building until they
are shipped to Guyana via the Temple's own ship. (u)

[redacted] work number is [redacted] if he can not
be reached at home. (u)

This information being furnished to aid in the
possible investigation of the PEOPLES TEMPLE. (u)

PCZ

89-4286-90

Buy U.S. Savings Bonds Regularly on the Payroll Savings Plan

ENCLOSURE

PAGE 2

b6
b7c

Memorandum

TO : SAC, SAN FRANCISCO (9-3277)

DATE: 11/18/78

FROM : SA ROBERT F. PEVAHOUSE

SUBJECT: PEOPLES TEMPLE OF THE DISCIPLES
OF CHRIST
JAMES JONES, aka
Temple Leader,
INFORMATION CONCERNING

ALL INFORMATION CONTAINED
HEREIN IS UNCLASSIFIED
DATE 9/17/92 BY 1048 DCM/jed

On 11/18/78, [redacted] Investigator, District Attorney's Office, San Francisco, California, advised his office had in the past conducted extensive investigation concerning the People's Temple, although they do not have a current case open in this regard. This investigation included monitoring of messages between the People's Temple in San Francisco and their settlement in Guyana. (u)

In view of the reported killing of Congressman LEO RYAN and others in his party at Guyana today, he wants to advise any information they have which may be of interest to this office would be made available. He can be reached through his office, telephone [redacted] or at his home, telephone [redacted] (u)

RFP:pp
(1)

89-4286-90

Buy U.S. Savings Bonds Regularly on the Payroll Savings Plan

ENCLOSURE

PAGE 3

b6
b7c

Memorandum

TO : SAC, SAN FRANCISCO (9-3277) (C)

DATE: 11/18/78

FROM : SA [redacted]

SUBJECT: PEOPLES TEMPLE OF THE DISCIPLES
OF CHRIST
JAMES JONES, aka
Jim Jones,
Temple Leader;
INFORMATION CONCERNING

ALL INFORMATION CONTAINED
HEREIN IS UNCLASSIFIED
DATE 9/17/92 BY 1048 DKN/rlm

On 11/18/78, [redacted] Reporter with the Examiner Newspaper, telephonically advised that in connection with the reported story that Congressman LEO RYAN had been killed in Guyana, he had been in contact with a member of the RYAN party in Guyana. He advised this person indicated several of the people with him felt that members of the Peoples Temple in the Bay Area will try to harm the families of the people in RYAN's party. Mr. [redacted] stated the person he spoke with in Guyana did not hear any specific threats, but, both he and several others in the group were afraid their relatives would be harmed. (u)

b6
b7C

Mr. [redacted] stated his source wanted him to call the FBI in San Francisco and furnish them with the following list of names of members of the Peoples Temple who might be responsible for any assaults on relatives in the Bay Area, if they should occur: (u)

- SANDY BRADSHAW aka Sandy Ingram
- LEONA COLLIER
- JUNE CHYM
- TOM ADAMS
- TIM CLANCY
- TERRY BUFORD
- TED HOLIDAY
- BONNIE BECK
- CLAIRE JANARO
- MIKE CLINGMAN
- PATTY CHASTIN
- PAT MARTIN
- JEANNIE BROWN
- TIM JAMES CARTER

OUP
(1)

89-4286-90

Buy U.S. Savings Bonds Regularly on the Payroll Savings Plan

ENCLOSURE

Memorandum

TO : Supv. Charles Hiner

DATE: 11/19/78

FROM : [redacted]
12:00-8:00

ALL INFORMATION CONTAINED
HEREIN IS UNCLASSIFIED
DATE 9/17/92 BY 1048 DKM/rdm
(u)

SUBJECT: People's Temple of the Disciples of Christ

At approx. 1230pm, writer was contacted by a Mr. [redacted] of Portland, OR. Mr. [redacted] telephonically related information concerning the possible development of a suicide pact within the People's Temple.

According to Mr. [redacted] Jim Jones, (leader of the People's Temple) has initiated a suicide pact among his followers. In accordance with the suicide pact, Jones' followers are to complete the execution of a hit list which names several of the party's enemies. After the completion of this hit list, the followers are to execute their children and then commit suicide.

Mr. [redacted] supplied SFFBI with the name of a [redacted] who is reportedly an ex-member of the People's Temple. [redacted] indicated that [redacted] has a list of members of the People's Temple who are planning attacks on enemies of the Temple. Upon receiving a telephone call from [redacted] writer determined that the given names appear on the memo written by SA [redacted] on 11/18/78. [redacted] indicated that she can be reached at [redacted]

Be advised that SFPD, (Officer [redacted]) and the District Attorney's office (Investigator [redacted]) have been notified of the above information.

(u)

DCC

89-4286-90

ENCLOSURE

PAGE 5

b6
b7C

Memorandum

TO : SAC, SAN FRANCISCO (9-377) (C) (99-10)

DATE: 8/28/78

FROM : SA [redacted]

SUBJECT: PEOPLES TEMPLE OF THE DISCIPLES
OF CHRIST
JAMES JONES, aka
Jim Jones,
Temple Leader;
INFORMATION CONCERNING

ALL INFORMATION CONTAINED
HEREIN IS UNCLASSIFIED
DATE 4/17/92 BY 1088 DCM/JSK

Attached to and considered a portion of this memo are various newspaper clippings relative to captioned church. Additionally, attached is one copy of a transcript of a radio broadcast between captioned church members in the U.S. and Guyana, South America, and one copy of code names used in the broadcast. Attached broadcast and code list was supplied by [redacted]. Also attached is an affidavit of [redacted] regarding the threat of possible mass suicide by members of the Peoples Temple. A copy of a letter to U.S. Senators and Members of Congress dated 3/14/78 on Peoples Temple stationery and signed by [redacted] and an affidavit of [redacted] showing the teachings and practices of Reverend JAMES WARREN JONES in Guyana, South America. (u)

b6
b7c

On July 28, 1978, this Agent interviewed [redacted] who in so [redacted] at his office, [redacted] San Francisco, California 94102, telephone [redacted] at the request of Mr. [redacted] (u)

[redacted] explained he had previously been asso- ciated with captioned church as a member and is [redacted] for the church. He advised he had known the pastor, JIM JONES, for several years and at one time he had been considered a high officer in the church. [redacted] advised he had been attracted to JONES due to his very liberal philosophy and his promise of Utopia for

[Handwritten signature]

(u)
FILED
AUG 28 1978

89-4286-98

Buy U.S. Savings Bonds Regularly on the Payroll Savings Plan

NY 9-2277
JL11880

the oppressed masses. [redacted] stated that he has since determined that JONES is a "phony humanitarian" and is in fact a "power hungry con." (u)

[redacted] advised that JONES and 1,100 church members had moved to what was supposed to have been a Utopian community in Guyana, South America, which is known as Jonestown. He said Jonestown is in fact a forced labor camp located in the middle of the Guyanese jungle. [redacted] described the community as being closed to the outside world and under the complete domination of JONES, who will not allow anyone to leave. (u)

[redacted] advised that JONES has such a charismatic hold on the 1,100 church members that very few have attempted to escape and the ones that have made such an attempt could not get through the dense jungle and were soon recaptured to be punished by being given an opportunity for self-examination and self-criticism while housed in a "tiger cage." [redacted] stated that he [redacted] had all been in Guyana, but he [redacted] had escaped. He advised that [redacted] continues to reside with JONES in Jonestown and JONES refuses to give [redacted] up.

[redacted] stated he has brought this matter to the attention of the U.S. State Department and has filed a suit to obtain [redacted] in Guyana. He advised that to date his attempts to obtain [redacted] have been unsuccessful. (u)

[redacted] advised that the majority of the background of the church and his conflict with the church is contained in the attached news articles. He stated he and some of the former members of the church have taken up a legal battle against JONES and the church. He advised that as a result JONES has become angry with [redacted]. He advised that [redacted] who has [redacted] in Jonestown, lives in [redacted] and has been in contact with the FBI. He advised that DEBORAH LAYTON had recently escaped from Jonestown and had made statements to the press regarding the conditions in Jonestown. (See attached news clipping.) (u)

NY 9. 3277
JL:mod

[redacted] stated that he monitors radio broadcasts between JONES and members of the Peoples Church in San Francisco and that he has become concerned that JONES may be plotting to kill [redacted] and himself. [redacted] stated that it is possible that one of JONES' enforcers, RONALD EDWARD SLY, may be flying to the U.S. from Guyana via Miami, Florida, enroute to San Francisco for the purpose of neutralizing the above group. He stated that it is possible that SLY may be carrying explosives with him. [redacted] went on to explain that the above is a assumption made by him, that he has no evidence to back up his feeling, but he feels that JONES has the potential for committing such an act. (u)

[redacted] stated he is not aware of JONES having done anything illegal and he has no evidence that JONES is actually plotting against his or anyone else's life. He advised he was aware there was no grounds for the FBI opening an active investigation in this matter, but he did want to make his information a matter of record with the FBI in the event something did happen that fell within the scope of the FBI. [redacted] also advised that [redacted] has advised him she is sorry she has become involved in the controversy about JONES and she does not desire to speak with the FBI or police. [redacted] stated he is in an unusual position because [redacted] is not only a friend and associate, but also he is her legal counsel. (u)

RECOMMENDATION: File for reference. (u)

b6
b7c

040

DEPARTMENT OF JUSTICE
FEDERAL BUREAU OF INVESTIGATION
COMMUNICATION MESSAGE FORM

PAGE 1 OF 2

DATE 11/20/78	CLASSIFICATION UNCLAS	PRECEDENCE PRIORITY
------------------	--------------------------	------------------------

\$F040PP DL SFDE HQ H0040 325\$HTYUWP 210434Z NOV 78

START HERE

FM DIRECTOR FBI
TO FBI DALLAS PRIORITY
FBI SAN FRANCISCO PRIORITY

BT

UNCLAS

RYMUR

ALL INFORMATION CONTAINED
HEREIN IS UNCLASSIFIED
DATE 9/17/92 BY 1048 DKA/udm

DO NOT TYPE PAST THIS LINE

RE DALLAS TELETYPE NOVEMBER 20, 1978 (u)

THE BUREAU HAS NO INFORMATION THAT PAST INVESTIGATION OF
THE PEOPLES TEMPLE CHURCH REVEALS THE POSSIBILITY THAT CERTAIN
CHURCH FOLLOWERS HAVE BEEN MURDERED. NOR IS IT KNOWN FROM A
REVIEW OF AVAILABLE INFORMATION AT FBIHQ WHETHER THREE
INNER CIRCLE MEMBERS OF PEOPLES TEMPLE DEFECTED FROM THE
CHURCH IN 1973. (u)

DALLAS SHOULD INSURE THAT EVERY EFFORT IS TAKEN TO
DEVELOP THE COOPERATION OF THE SOURCE OF INFORMATION SET
FORTH IN RETEL. (u)

BT

REC-102

89-4286-91

DO NOT TYPE MESSAGE BELOW THIS LINE

APPROVED BY DWM/LFS	DRAFTED BY LFS:BVM	DATE 11/20/78	ROOM 5027	TELE EXT 2805
------------------------	-----------------------	------------------	--------------	------------------

1 - MR. STEPHENS

FEDERAL BUREAU OF INVESTIGATION
COMMUNICATIONS SECTION

NOV 21 1978
12322 CH
TELETYPE

2 NOV 22 1978

58 NOV 28 1978

DEPARTMENT OF JUSTICE
FEDERAL BUREAU OF INVESTIGATION
COMMUNICATION MESSAGE FORM

PAGE 2

CONTINUATION SHEET

START HERE

20
18
16
14
12
10
8
6
4
2

DO NOT TYPE PAST THIS LINE

DO NOT TYPE MESSAGE BELOW THIS LINE

NOTE: ABOVE RESPONDS TO DALLAS TELETYPE OF 11/20/78 SETTING FORTH
INFORMATION REGARDING ILLEGAL ACTIVITIES OF JIM JONES, DBA
PEOPLES TEMPLE CHURCH, ETC.

SF0579 3240438Z

20 Nov 78 04 51z

OO HQ LA

DE SF 002

0 190436Z NOV 78

RECEIVED
FEDERAL BUREAU
OF INVESTIGATION
COMMUNICATIONS SECTION
ALL INFORMATION CONTAINED
HEREIN IS UNCLASSIFIED
DATE 9/12/92 BY 1048 DKN/ndh

Assoc. Dir.	_____
Dep. AD Adm.	_____
Dep. AD Inv.	_____
Asst. Dir.:	_____
Adm. Serv.	_____
Crim. Inv.	_____
Ident.	_____
Intell.	_____
Laboratory	_____
Legal Coun.	_____
Plan. & Insp.	_____
Rec. Ment.	_____
Tech. Servs.	_____
Training	_____
Public Affs. Off.	_____
Telephone Rm.	_____
Director's Sec'y	_____

FM SAN FRANCISCO (89-NEW) (P) (SQUAD 10)

TO DIRECTOR, FBI IMMEDIATE

LOS ANGELES IMMEDIATE (LA VIA FBIHQ)

BT

James WARE James JONES Jimmy JONES Mulan INDIANA

UNCLAS E F T O

PEOPLE'S TEMPLE - REVEREND JIM JONES, 1859 GEARY BOULEVARD,

SAN FRANCISCO; CAS - CONSPIRACY; POSSIBLE AFO; OO: SAN FRANCISCO.

White
MLL
BORN 5/13/31
INDIANA

DE-5 REC-102 89-4286-92

RE SAN FRANCISCO TELETYPE TO BUREAU NOVEMBER 19, 1978,

CAPTIONED "PEOPLE'S TEMPLE, INFORMATION CONCERNING, 89-NEW". (u)

INTERVIEWS CONDUCTED THIS DATE AT HUMAN FREEDOM CENTER, 3028 REGENT STREET, BERKELEY, CALIFORNIA, WITH SEVEN FORMER MEMBERS OF THE PEOPLE'S TEMPLE (PT), SIX OF THESE INTERVIEWED WERE FORMER MEMBERS OF THE PLANNING COMMISSION, WHICH IS AN INNERCIRCLE OF THE PT. THREE FORMER PLANNING COMMISSION MEMBERS FURNISHED SIGNED STATEMENTS. THE HUMAN FREEDOM CENTER HOUSES FORMER MEMBERS OF THE PT AND LISTS AS ITS PURPOSE TO ASSIST FORMER MEMBERS OF CULT GROUPS TO READJUST TO SOCIETY. (u)

NOV 24 1978

TELETYPED TO:
LA 58 NOV 21 1978

PAGE TWO SF 89-NEW UNCLAS E F T O

ALL PERSONS INTERVIEWED STATED THE REVEREND JIM JONES COERCED THEM INTO MAKING WRITTEN STATEMENTS TO KILL PRESIDENT NIXON AND ALSO STATEMENTS INCRIMINATING THEMSELVES IN CRIMINAL OR IMMORAL ACTS. PART OF THE DUTIES OF THE PLANNING COMMISSION MEMBERS WERE TO PICK UP THESE WRITTEN STATEMENTS FROM MEMBERS AND DELIVER THEM TO REVEREND JONES WHO USED THESE STATEMENTS TO INSURE THE MEMBERS INVOLVEMENT IN THE PT MOVEMENT. (u)

ALL PERSONS INTERVIEWED STATED THE PT HAVE A CONTINUING PROGRAM OF THE COLLECTION AND CACHEING OF FIREARMS, ALSO IN ENGAGING IN FIREARMS TRAINING IN THE UKAIAH, CALIFORNIA AND SAN FRANCISCO AREAS. REVEREND JONES PROMOTED THE THREAT OR ACTUAL USE OF VIOLENCE TO KEEP MEMBERS IN LINE FROM ANY OUTSIDE INTRUSION. (u)

THE FORMER MEMBERS INTERVIEWED IDENTIFIED A NUMBER OF INDIVIDUALS WHO ARE "CORE" AND "HIT MEN" WHO WERE DIRECTED BY JONES. (u)

ALLEGATIONS WERE RECEIVED THAT NUMEROUS WEAPONS SHIPMENTS WERE MADE FROM UNITED STATES TEMPLE MEMBERS TO REVEREND JONES PT MOVEMENT IN GUYANA. FURTHER, THAT A LARGE WEAPONS CACHE IS STILL LOCATED IN THE PT IN SAN FRANCISCO. (u)

PAGE THREE SF 89-NEW UNCLAS E F T O

CERTAIN PLANNING COMMISSION MEMBERS STATED THEY HEARD THE REVEREND JIM JONES ON SEVERAL OCCASIONS URGE THE CREATION OF A "CONTINGENCY PLAN" WHICH WOULD GO INTO EFFECT IN THE EVENT OF HIS ARREST OR CAPTURE. JONES INSTRUCTED PT MEMBERS TO MAKE PLANS TO KIDNAP PUBLIC OFFICIALS AND HOLD THEM HOSTAGE UNTIL HIS RELEASE WAS SECURED. NO EVIDENCE HAS BEEN OBTAINED FROM FORMER MEMBERS INTERVIEWED TO DATE THAT SUCH A PLAN WAS FORMULATED OR THAT ANY PERSONS HAVE BEEN DESIGNATED FOR SUCH A PLANS EXECUTION. HOWEVER, THOSE INTERVIEWED STATED THAT PERSONS WHO WOULD BE INVOLVED IN SUCH A PLAN ARE STILL AMONG THE CORE OF THE PT BOTH IN GUYANA AND SAN FRANCISCO. (u)

INFORMATION BEING FURNISHED TO LOS ANGELES INASMUCH AS A FORMER ACTIVE PT EXISTED AT THE INTERSECTION OF HOOVER AND ALVARADO STREETS IN LOS ANGELES, CALIFORNIA AND POSSIBLE INTERVIEWS MAY BE REQUESTED IN THAT DIVISION. (u)

INVESTIGATION CONTINUING AT SAN FRANCISCO. (u)

BT

634
SFO 3252149

21 Nov 78 22 11z

OO HQ

DE SF 0008

O 22145Z NOV 78 SAN FRANCISCO (89-250) (P) (SQ. 10)

TO DIRECTOR, FBI IMMEDIATE

BT

RECEIVED
FEDERAL BUREAU
OF INVESTIGATION
COMMUNICATIONS SECTION

Assoc. Dir.	_____
Dep. AD Adm.	_____
Dep. AD Inv.	_____
Asst. Dir.:	_____
Adm. Serv.	_____
Crim. Inv.	_____
Ident.	_____
Intell.	_____
Laboratory	_____
Legal Coun.	_____
Plan. & Insp.	_____
Rec. Mgmt.	_____
Tech. Servs.	_____
Training	_____
Public Affs. Off.	_____
Telephone Rm.	_____
Director's Sec'y	_____

ALL INFORMATION CONTAINED
HEREIN IS UNCLASSIFIED
DATE 4/17/92 BY 1048 DKM/rdm

UNCLAS
RYMUR

DR. [REDACTED] PHD, UNIVERSITY OF CALIFORNIA,
 BERKELEY, A CONSULTANT TO THE GOVERNMENT OF FRANCE, ITALY AND
 SWITZERLAND AND THE SAN FRANCISCO POLICE DEPARTMENT IN TERRORIST
 MATTERS AND A CONSULTANT TO THE FBI, SAN FRANCISCO IN OUR
 RESPONSE PLAN FOR NUCLEAR EXTORTION VOLUNTARILY SUBMITTED A
 MEMORANDUM RELATING TO THE POSSIBLE PSYCHOLOGICAL PROFILE OF
 MEMBERS OF THE PEOPLE'S TEMPLE (PT). IT IS BEING FORWARDED TO
 THE FBIHQ VERBATIM FOR THEIR CONSIDERATION IN CONDUCTING
 INTERVIEWS IN GUYANA. SAN FRANCISCO IS MAINTAINING CONTACT
 WITH DR. [REDACTED] AND WILL USE HIS SERVICES IF DEEMED APPROPRIATE.

CA

b6
b7c

REC-102 89-4286-93

THE FOLLOWING IS THE TEXT OF DR. [REDACTED] S MEMO: (u)

22 NOV 24 1978

SHAW

ST

58 NOV 28 1978

WE HAVE RECENTLY OBTAINED A GREAT DEAL OF INFORMATION ABOUT WHAT HAPPENS WHEN THIS KIND OF BONDED RELIGIOUS SYSTEM BEGINS TO BREAK UP. EVEN PEOPLE WITHIN THE SYSTEM WHO ARE NAIVE ABOUT THE NEGATIVE ACTIVITIES WILL HAVE HALLUCINATIONS AND DELUSIONS AND FEAR THAT THEY ARE NOT ONLY LOSING THEIR RELIGIOUS BASE, BUT ARE ALSO GOING CRAZY. THEY WILL NOT TALK ABOUT THIS FOR THOSE REASONS. THEY TEND TO LOOK FOR THE ALTERNATIVE TO THE MYSTIC SYSTEM. FOR EXAMPLE, INSTEAD OF A RELIGIOUS MYSTICAL SYSTEM, THEY WILL TURN TO AN OPPOSITE SUCH AS A SCIENTIFIC SYSTEM, IN AN EFFORT TO FIND A REASON FOR THEIR OWN BEHAVIOR. EXAMPLES OF THIS WOULD BE SEEKING A PSYCHOLOGICAL OR PSYCHIATRIC RATIONALE BECAUSE OF COMPETING RELIGIOUS OR PRIEST-LIKE FIGURE IS NO LONGER SOMEONE THAT THEY CAN TRUST. ANOTHER EXAMPLE OF THIS IS IN THE KIND OF BEHAVIOR MODIFICATION COMBINED WITH CHARISMA EMPLOYED BY MOONEY DEPROGRAMMERS. WE KNOW THAT IN A NUMBER OF MOONEY DEFECTIONS, AS WELL AS RECENT INFORMATION IN THE CHOWCHILLA KIDNAPPING, THAT THESE HALLUCINATIONS AND DELUSIONS ARE NOT REVEALED TO AGENT INTERVIEWERS. THE BOY WHO ACTED OUT THE HERO'S ROLE IN CHOWCHILLA, INITIALLY REMOVED THE METAL PLATE LEADING TO THE

(W)

TOP OF THE BUNKER AND HALLUNCINATED THAT HE HAD BURROWED INTO THE VAN THAT HAD TAKEN THEM TO THE QUARRY. HE BECAME FRI^GHTENED, AND WENT BACK DOWN INTO THE BURIED BUS, WAITED ABOUT 20 MINUTES, WENT BACK TO THE TOP AND THIS TIME HALLUNCINATED ABOUT TREES AND RUNNING WATER (WHICH DO NOT EXIST AT THE SITE). THIS INFORMATION WAS NOT REVEALED DESPITE NUMEROUS INTERVIEWS BY AGENTS. ONE AND A HALF YEARS LATER, THIS BOY DEVELOPED A HERO COMPLEX IN WHICH HE FELT THAT FATE HAD TOUCHED HIM TO ACT AS A GUARDIAN OF OTHERS. SEVERAL MONTHS AGO, HE SHOT A JAPANESE TOURIST IN A STALLED CAR IN FRONT OF HIS HOME. THERE ARE A NUMBER OF OTHER EXAMPLES OF THIS TYPE OF PROCESS WHEREIN THE MIDST OF HOMICIDAL OR SUICIDAL TENSION, MEMBERS OF RELIGIOUS GROUPS WILL FEEL THAT THE MANTLE OF RESPONSIBILITY HAS PASSED TO THEM. IT IS IMPORTANT FOR AGENTS IN THEIR INTERVIEWS OF JONESTOWN RESIDENTS TO CAREFULLY FIND OUT WHAT ROLES THE SURVIVORS SAW THEMSELVES IN AS THEY WERE FLEEING THE MASS SUICIDE. THIS IS BECAUSE OF THIS HERO COMPLEX AND CHRONICLED EVENTS WHICH INDICATE THAT A RE-OCCURENCE OF VIOLENCE IS PROBABLE IN THESE INDIVIDUALS. IT IS EQUALLY IMPORTANT THAT SUBSTANTIAL EFFORTS BE MADE TO TRACK THE RESIDENTS IN THAT SUCH BEHAVIOR.

(u)

3

EASILY HAS A TIME DELAY OF ONE AND ONE HALF TO TWO YEARS. A MANAGEMENT DECISION SHOULD BE MADE WITH REGARD TO THE ADVISABILITY OF USING (1) SOME ORIENTATION OR BRIEFING TO AGENTS ABOUT THESE DYNAMICS AND/OR (2) THE USE OF BUREAU APPROVED PSYCHOLOGISTS TO ASSIST IN SOME OF THE INTERVIEWING TO TAKE ADVANTAGE OF THIS "CONFESSION" PHENOMENA DESCRIBED ABOVE. (U)

COMPARISON OF IDEOLOGICAL TRACTS OF JONES AND MANSON ARE ALMOST IDENTICAL. EACH DESCRIBES AND USED WITH THEIR FOLLOWERS THE INEVITABILITY OF AN INTERRACIAL WAR WHICH WOULD BE SIGNATED BY SOME TYPE OF APOCALYPTIC EVENT. THE IDEOLOGIES ARE SO IDENTICAL THAT IT IS RECOMMENDED THAT SOME SORT OF TRACKING OF CURRENTLY IMPRISONED MANSON FOLLOWERS' CONTACTS BE CAREFULLY STUDIED FOR THE NEXT SEVERAL WEEKS. BECAUSE OF MANSON'S RECENT PAROLE REJECTION, AND THE FACT THAT THIS EVENT IS EXACTLY WHAT MANSON PREDICTED TO HIS FOLLOWERS, THE POSSIBILITY OF SOME SORT OF STRATEGY ON THEIR PART IS VERY HIGH AT THIS TIME. (U)

SUMMARY RECOMMENDATIONS (U)

1. CONSIDER BRIEFING OF AGENTS WHO ARE TO DO RESIDENT (U)

4

PAGE FIVE

SF 89-250

UNCLAS

INTERVIEWS. (u)

2. CONSIDER ROLE OF BUREAU APPROVED PSYCHOLOGISTS. (u)
3. CONSIDER NEED FOR EVALUATION OF MANSON FOLLOWERS'

CONTACTS. (u)

BT

5

SF0642 325230Z

OO HQ DL

DE SF 016

O 2230Z NOV 7

FM SAN FRANCISCO (89-250) (P)

TO DIRECTOR IMMEDIATE

DALLAS IMMEDIATE

BT

UNCLAS

RYMUR

21 NOV 78 23 10z

FEDERAL BUREAU OF INVESTIGATION COMMUNICATIONS SECTION

Asso. Dir.	_____
Dep. AD Adm.	_____
Dep. AD Inv.	_____
Asst. Dir.:	_____
Adm. Serv.	_____
Crim. Inv.	_____
Ident.	_____
Intell.	_____
Laboratory	_____
Legal Coun.	_____
Plan. & Insp.	_____
Rec. Mgnt.	_____
Tech. Servs.	_____
Training	_____
Public Affs. Off.	_____
Telephone Rm.	_____
Director's Sec'y	_____

ALL INFORMATION CONTAINED HEREIN IS UNCLASSIFIED DATE 9/17/92 BY 1098DKP/mdm



b6 b7C

RE SAN FRANCISCO TELEPHONE CALL TO DALLAS THIS DATE TO

SA CLOW (u)

AS MENTIONED IN RE CALL, [REDACTED] MAY BE IDENTICAL WITH [REDACTED], WHO WAS KNOWN TO BE [REDACTED] AND KNOWN TO BE A PEOPLE'S TEMPLE (PT) MEMBER WHO HAD [REDACTED] FOR JONES.



b6 b7C

LEAD TO ATTEMPT TO VERIFY ATTENDANCE AT [REDACTED] HAS BEEN SET FORTH. (u)

89-4 286-94

REC-102

DALLAS. ATTEMPT FURTHER INTERVIEWS AND ATTEMPT TO SECURE SIGNED STATEMENTS FROM SOURCE. ADVISE OF ANY DEVELOPMENTS. (u)

22 NOV 24 1978

"ARMED AND DANGEROUS. SUICIDAL TENDENCIES". (u)

BT

LEADAS [Handwritten signature]

58 NOV 28 1978

SF0643 3252307Z

OO HQ LA DN

DE SF 017

O 22304Z NOV 7

FM SAN FRA CISCO (89-250) (P) (SQ000000) COMMUNICATIONS SECTION

21 Nov 78 23 17z

RECEIVED
FEDERAL BUREAU
OF INVESTIGATION
COMMUNICATIONS SECTION

Assoc. Dir.	
Dep. AD Adm.	
Dep. AD Inv.	
Asst. Dir.:	
Adm. Serv.	
Crim. Inv.	
Ident.	
Insp.	
Laboratory	
Legal Coun.	
Plan. & Insp.	
Rec. Mgmt.	
Tech. Serv.	
Training	
Off. Affs. Off.	
Phone Rm.	
Director's Sec'y	

TO DIRECTOR IMMEDIATE

LOS ANGELES IMMEDIATE (LA VIA FBIHQ)

DENVER IMMEDIATE

BT

UNCLAS
RYMUR

ALL INFORMATION CONTAINED
HEREIN IS UNCLASSIFIED
DATE 9/17/92 BY 1048 DCM/rdm

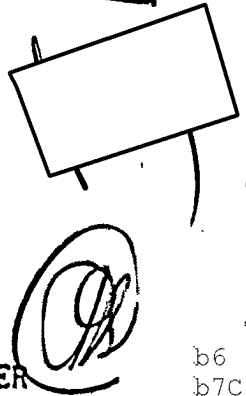

RE BUREAU TELETYPE TO ALL OFFICES, NOVEMBER 20, 1978;

SAN FRANCISCO TELEPHONE CALLS TO LOS ANGELES AND DENVER, NOVEMBER 21, 1978. (u)

b6
b7c

INTERVIEW OF FORMER MEMBERS OF PEOPLE'S TEMPLE (PT) DETERMINED THAT JACK ARNOLD BEAN, SR., JAMES MC ELVANE AND

[REDACTED] HIGH MEMBERS OF PT WERE INVOLVED IN BEATING UP

[REDACTED] IN DENVER, COLORADO. [REDACTED] FORMER LOS ANGELES PASTOR

AND DISSIDENT PT MEMBER, LAST KNOWN TO BE IN DENVER AREA (u)

89-4286-95
NOV 24 1978

REC-102

RETYPE TO:

6758 NOV 28 1978

[REDACTED] WHO IS SUPPOSED TO HAVE DEFECTED FROM CHURCH AND WOULD BE VERY KNOWLEDGEABLE RE PT ACTIVITIES, CONTINGENCY PLANS OF PT TO KILL PUBLIC OFFICIALS, FIREARMS, COLLECTION, CACHE AND TRAINING, AS WELL AS IDENTITY OF HIGH PT MEMBERS (u)

LOS ANGELES POLICE DEPARTMENT DETECTIVE [REDACTED] SHOULD HAVE KNOWLEDGE OF ASSAULT OF [REDACTED] AND POSSIBLY LOCATION OF [REDACTED] (u)

DENVER IS REQUESTED TO LOCATE AND INTERVIEW [REDACTED] THROUGH LOGICAL SOURCES AND POSSIBLE DENVER POLICE DEPARTMENT VICTIM REPORT. (u)

LOS ANGELES IS REQUESTED TO LOCATE [REDACTED], THROUGH DETECTIVE [REDACTED] AND THOROUGHLY INTERVIEW [REDACTED] ALSO OBTAIN BACKGROUND TO FURNISH DENVER. (u)

IN ADDITION, LOS ANGELES REQUESTED TO OBTAIN INFORMATION FROM [REDACTED] AS TO HISTORY OF PT ILLEGAL ACTIVITIES AND MEMBERS IN LOS ANGELES AND IDENTITY AND LOCATION OF FORMER PT MEMBERS FOR INTERVIEW. (u)

ALSO NOTE [REDACTED] MAY ALSO BE DISSIDENT MEMBER (u)
"ARMED AND DANGEROUS. SUICIDAL TENDENCIES". (u)

BT

b6
b7c

2

SC0004 3252033Z

00 HI SF

DE SC

0 212033Z NOV 78

FM SACRAMENTO (89-191) (P)

TO DIRECTOR IMMEDIATE

SAN FRANCISCO (89-250) IMMEDIATE

BT

UNCLAS
RYMUR.

21 Nov 78 20 49z
RECEIVED
FEDERAL BUREAU
OF INVESTIGATION
COMMUNICATIONS SECTION

Assoc. Dir.	
Dep. AD Adm.	
Dep. AD Inv.	
Asst. Dir.:	
Adm. Serv.	
Crim. Inv.	<i>M/S</i>
Ident.	
Intell.	
Laboratory	
Legal Coun.	
Plan. & Insp.	
Rec. Mgmt.	
Tech. Servs.	
Training	
Public Affs. Off.	
Telephone Rm.	
Director's Sec'y	

ALL INFORMATION CONTAINED
HEREIN IS UNCLASSIFIED
DATE 9/17/82 BY 1048 DKM/ndm

b6
b7c

RE SAN FRANCISCO TELETYPES AND TELCALLS TO SACRAMENTO,
NOV. 20 AND 21, 1978, AND SACRAMENTO TELCALL TO SAN FRANCISCO,
NOV. 20, 1978. (u)

ON NOV. 21, 1978, [REDACTED] OCCIB, CALIFORNIA
DEPARTMENT OF JUSTICE, MADE AVAILABLE THE ARTICLES OF INCOR-
PORATION OF THE PEOPLE'S TEMPLE OF THE DISCIPLES OF CHRIST.
THE ORIGINAL ARTICLES OF INCORPORATION WERE DATED JULY 30,
1965, AND FILED WITH THE CALIFORNIA SECRETARY OF STATE, NOV.
26, 1965. THE ORIGINAL ARTICLES WERE SIGNED BY JAMES W. JONES,
PRESIDENT, AND MARCELINE M. JONES, SECRETARY. THE ORIGINAL

REC-102 89-4286-96

NOV 24 1978

SET OUT LEADS

STX

58 NOV 28 1978

PAGE TWO SC 89-191 UNCLAS

ARTICLES OF INCORPORATION LISTED THE DIRECTORS AS JAMES W. JONES AND MARCELINE M. JONES, BOTH OF BOX 402J, ROUTE 1, REDWOOD VALLEY, CALIFORNIA. THE THIRD DIRECTOR WAS ARCHIE J. IJAMES, SAME ADDRESS. THE ARTICLES STATE THAT THE PRINCIPLE OFFICE FOR THE TRANSACTION OF BUSINESS OF THE CORPORATION IS LOCATED IN MENDOCINO COUNTY, CALIFORNIA. (u)

THE ANNUAL STATEMENT, WHICH MUST BE FILED BY A DOMESTIC CORPORATION IN THE STATE OF CALIFORNIA, LISTS THE PRINCIPLE OFFICE OF THE CORPORATION AS 1859 GEARY BLVD., SAN FRANCISCO. THE OFFICERS ARE LISTED AS FOLLOWS: (u)

PRESIDENT, CAROL A. STAHL, 2451 ROAD K, REDWOOD VALLEY, CALIFORNIA. VICE PRESIDENT, LEE INGRAM, 1859 GEARY BLVD., SAN FRANCISCO. SECRETARY, LINDA S. AMOS, 1859 GEARY BLVD., SAN FRANCISCO. TREASURER, JUNE B. CRYM, 1859 GEARY BLVD., SAN FRANCISCO. THE STATEMENT WAS FILED WITH THE CALIFORNIA SECRETARY OF STATE'S OFFICE ON APRIL 14, 1978 (u)

AN AMENDMENT TO THE ARTICLES OF INCORPORATION FILED JULY 3, 1974, LISTS MICHAEL B. CARTMELL AS VICE PRESIDENT OF THE CORPORATION AND JEAN F. BROWN AS ASSISTANT SECRETARY OF THE CORPORATION. NO ADDRESS IS LISTED FOR EITHER INDIVIDUAL. (u)

2

PAGE THREE SC 89-191 UNCLAS

AN ADDITIONAL AMENDMENT TO THE ARTICLES OF INCORPORATION FILED DEC. 31, 1976, LISTS BROWN AS ASSISTANT SECRETARY AND ARCHIE IJAMES AS VICE PRESIDENT. NO ADDRESS IS GIVEN FOR EITHER INDIVIDUAL (u)

AS SAN FRANCISCO WAS ADVISED IN REFERENCED SACRAMENTO TELCALL, ON NOV. 20, 1978, DR. [REDACTED] DIRECTOR, CALIF. DEPARTMENT OF DEVELOPMENTAL SERVICES, SACRAMENTO, TELEPHONICALLY ADVISED SACRAMENTO AS FOLLOWS (u)

HIS DEPARTMENT HAD CONDUCTED AN INVESTIGATION INTO A HOME KNOWN AS HAPPY ACRES LOCATED IN UKIAH, CALIFORNIA. CLIENTS OF THE DEPARTMENT, ALL MENTALLY RETARDED ADULT MALES, HAVE BEEN QUARTERED AT HAPPY ACRES FOR SOME TIME AND THE INVESTIGATION WAS CONDUCTED CONCERNING ALLEGATIONS OF MISTREATMENT OF THE CLIENTS AND POSSIBLY MISUSE OF FEDERAL AND STATE FUNDS. NONE OF THE ALLEGATIONS WERE SUBSTANTIATED, HOWEVER, INFORMATION WAS DEVELOPED DURING THE INVESTIGATION THAT HAPPY ACRES WAS LICENSED BY MR. AND MRS. RICHARD JANARO AT THE TIME OF THE INVESTIGATION. THE NAME OF THE LICENSEE HAS SUBSEQUENTLY BEEN CHANGED AND IS CURRENTLY LICENSED BY A MR. AND MRS. BECKING, (u)

b6
b7c

3

PAGE FOUR SC 89-191 UNCLAS

NOT FURTHER IDENTIFIED. THE INVESTIGATION ALSO DETERMINED THAT THE JANAROS AND POSSIBLY THE BECKINGS WERE MEMBERS OF THE PEOPLE'S TEMPLE (U).

ON NOV. 20, 1978 [REDACTED] DEPUTY SHERIFF, MENDOCINO COUNTY SHERIFF'S DEPARTMENT, CONTACTED THE DEPARTMENT OF DEVELOPMENTAL SERVICES CHIEF INVESTIGATOR [REDACTED] IT IS NOTED THAT [REDACTED] HAD WORKED WITH [REDACTED] ON THE ORIGINAL INVESTIGATION OF HAPPY ACRES (U)

[REDACTED] ADVISED THAT ALLEGEDLY RICHARD JANARO HAD GONE TO GUYANA APPROXIMATELY ONE YEAR AGO AND THAT ONE TO TWO WEEKS AGO MRS. JANARO HAD GONE TO GUYANA, PRESUMABLY TO GO TO THE PEOPLE'S TEMPLE COLONY THERE. ALLEGEDLY BOTH JANAROS ARE IN TRINIDAD AT THIS TIME AND THE MENDOCINO COUNTY SHERIFF'S DEPARTMENT HAD SOME INDICATION THAT THEY WERE POSSIBLY TO BE MEMBERS OF AN ASSASSINATION TEAM COMING INTO THE MENDOCINO COUNTY AREA. NEITHER [REDACTED] NOR DR. [REDACTED] HAD ANY INDICATION OF WHERE THE MENDOCINO COUNTY SHERIFF'S DEPARTMENT HAD OBTAINED THE INFORMATION ABOUT A POSSIBLE ASSASSINATION TEAM. (U)

FOR THE INFORMATION OF THE BUREAU, THE SAN FRANCISCO (U)

b6
b7c

2

PAGE FIVE SC 89-191 UNCLAS

OFFICE ADVISED ON NOV. 20, 1978, THAT THEY WERE AWARE OF
THE OWNERSHIP OF THE ESTABLISHMENT IN MENDOCINO COUNTY AND
HAD ALERTED THE AUTHORITIES THERE TO THE POSSIBILITY THAT
MEMBERS OF THE PEOPLE'S TEMPLE WERE STILL AFFILIATED WITH
HAPPY ACRES. IT IS POSSIBLE THAT THIS IS THE INFORMATION
WHICH WAS RELAYED TO DR. [REDACTED] BUT SOMEWHAT ENLARGED UPON. (u)

b6
b7c

COPIES OF THE PEOPLE'S TEMPLE ARTICLES OF INCORPORATION
WILL BE FURNISHED SAN FRANCISCO BY AIRTEL. (u)

BT

5

SFO 630 3252005

PP HQ SD

DE SF 0005

P 212002Z NOV 78

FM SAN FRANCISCO (89-250) (P) (SQ. 10)

TO DIRECTOR PRIORITY

SAN DIEGO PRIORITY

BT

UNCLASSIFIED

RYMUR

21 NOV 78 20 17z

RECEIVED
FEDERAL BUREAU
OF INVESTIGATION
COMMUNICATIONS SECTION

Assoc. Dir.	_____
Dep. AD Adm.	_____
Dep. AD Inv.	_____
Asst. Dir.:	_____
Adm. Serv.	_____
Crim.	_____
Ident.	_____
Intell.	_____
Laboratory	_____
Legal Coun.	_____
Plan. & Insp.	_____
Rec. Mgnt.	_____
Tech. Servs.	_____
Training	_____
Public Affs. Off.	_____
Telephone Rm.	_____
Director's Sec'y	_____

ALL INFORMATION CONTAINED
HEREIN IS UNCLASSIFIED
DATE 9/12/92 BY 1048 DCM/mch

RE BUREAU TELETYPE TO ALL OFFICES, NOVEMBER 20, 1978;

SAN FRANCISCO TELEPHONE CALL TO SUPERVISOR [REDACTED] NOVEMBER

21, 1978. (u)

[REDACTED] FORMER MEMBER OF PEOPLE'S TEMPLE (PT), SAN FRANCISCO, ADVISED THIS DATE, [REDACTED] DON SLY, ALSO A MEMBER OF THE PT IN GUYANA, WAS THE HEAD OF THE "ASSASSINATION SQUAD". (u)

b6
b7c

REC-102

89-4286-97

[REDACTED] HAS CONTACTED HER PARENTS, [REDACTED]

[REDACTED] SAN DIEGO, CALIFORNIA, TELEPHONE [REDACTED] AND 22 NOV 24 1978

REQUESTED THEY DELIVER TO FBI OFFICE, SAN DIEGO, MOST RECENT

PICTURES OF DON SLY. (u)

58 NOV 28 1978

PAGE TWO SF 89-250 UNCLASSIFIED

SAN DIEGO. CONTACT AND

b6
b7C

OBTAIN PHOTOGRAPH OF DON SLY. (u)

"ARMED AND DANGEROUS. SUICIDAL TENDENCIES". (u)

BT

SF0631 3252008

PP HQ SC

DE SF 0006

P 21195Z NOV 78

FM SAN FRANCISCO (89-250) (P) (SQ. 10)

TO DIRECTOR PRIORITY

SACRAMENTO PRIORITY

BT

UNCLASSIFIED

RYMUR

21 Nov 78 20 17z

RECEIVED
FEDERAL BUREAU
OF INVESTIGATION
COMMUNICATIONS SECTION

ALL INFORMATION CONTAINED
HEREIN IS UNCLASSIFIED
DATE 9/12/92 BY 1048 DCM/fab

Assoc. Dir.	_____
Dep. AD Adm.	_____
Dep. AD Inv.	_____
Asst. Dir.:	_____
Adm. Serv.	_____
Crim. Inv.	_____
Ident.	_____
Intell.	_____
Laboratory	_____
Legal Coun.	_____
Plan. & Insp.	_____
Rec. Mgnt.	_____
Tech. Servs.	_____
Training	_____
Public Affs. Off.	_____
Telephone Rm.	_____
Director's Sec'y	_____



RE BUREAU TELETYPE TO ALL OFFICES; SAN FRANCISCO
TELEPHONE CALL TO SACRAMENTO, NOVEMBER 21, 1978. (u)

b6
b7c

INTERVIEW OF FORMER MEMBERS OF PEOPLE'S TEMPLE (PT)
INDICATES THAT A [REDACTED] AND HIS WIFE, [REDACTED]
FRESNO, CALIFORNIA, TELEPHONE [REDACTED] BOTH FORMER
MEMBERS ON THE PLANNING COMMISSION OF THE PT. INFORMATION
DEVELOPED THAT INVESTIGATOR FOR THE SECRETARY OF STATE, [REDACTED]

[REDACTED] (PH), HAS BACKGROUND INFORMATION RE THE PT. (u)

REC-102

SAC LEAD 89-4286-98
22 NOV 24 1978

Handwritten initials



58 NOV 28 1978

PAGE TWO SF 89-250 UNCLASSIFIED

SACRAMENTO REQUESTED TO CONTACT [REDACTED] AND OBTAIN ANY INFORMATION REGARDING PT ACTIVITIES AND MEMBERS. (u)

b6
b7c

AT FRESNO, CALIFORNIA. INTERVIEW [REDACTED] AND HIS WIFE IN DEPTH REGARDING PREVIOUS ASSOCIATION OF PT KNOWLEDGE OF THREATS OR CONSPIRACY AGAINST PUBLIC OFFICIALS, WEAPONS CACHEING AND SHIPMENT AND TRAINING, CONTINGENCY PLANS OF PT AND KNOWLEDGE OF "HIT MEN". (u)

BT

2

4188

096.

097

PRECEDENCE:

- IMMEDIATE
- PRIORITY
- ROUTINE

MESSAGE RELAY VIA TELETYPE

Date 11/21/78

- CLASSIFICATION:
- TOP SECRET
 - SECRET
 - CONFIDENTIAL
 - UNCLASSIFIED

FIELD AND LEGAT MESSAGES ONLY CLEAR EFTO

FM: DIRECTOR FEDERAL GOVERNMENT TO:

~~CONFIDENTIAL~~

ALL INFORMATION CONTAINED HEREIN IS UNCLASSIFIED DATE 9/17/92 BY 1048 DICM/mdm

Handwritten initials and a circled 'A'.

- Attorney General
- Deputy Attorney General
- Attn: Emergency Programs Center
- Assistant Attorney General, Civil Rights Div.
- Assistant Attorney General, Criminal Div.
- Attn: Internal Security Section
- Attn: General Crimes Section
- Immigration and Naturalization Service
- U. S. Marshal's Service
- U. S. Secret Service (PID)
- Director, CIA
- Secretary of State
- Department of Treasury
- Attn: U. S. Customs
- Department of Treasury
- Attn: Bureau of Alcohol Tobacco & Firearms

- Drug Enforcement Administration
- Energy Research and Development Administration
- U. S. Postal Service
- National Aeronautics & Space Adm.
- Department of Transportation
- Attn: Director of Security
- Federal Aviation Administration
- Department of the Air Force (AFOSI)
- Department of the Army
- Naval Investigative Service
- National Security Agency (DIRNSA/NSOC (Attn: SOO))
- Commandant, U. S. Coast Guard
- Director, Defense Intelligence Agency

- The President
- White House Situation Room
- Attn:
- The Vice President
- Attn:
- Dept. of Defense
-

Handwritten notes: "Secret", "11/21/78", "11/21/78"

89-4286-99
NOV 24 1978

REC-102

(SUBJECT (TEXT BEGINS NEXT PAGE):

UNKNOWN SUBJECTS;
CONGRESSMAN LEO J. RYAN - VICTIM
CONGRESSIONAL ASSASSINATION STATUTE;
FOREIGN POLICE COOPERATION

~~CONFIDENTIAL~~

- Foreign Liaison Unit
- Route through for review
 - Cleared telephonically

CLASSIFIED BY 6419 (11/30/78)
EXEMPT FROM GENERAL DECLASSIFICATION
SCHEDULE OF EXECUTIVE ORDER 11652
EXEMPTION CATEGORY 3

AUTOMATICALLY DECLASSIFIED ON Indefinite

ORIGINATOR SA [redacted]

RM 5030 EXT 4188

- Sec. Dir.
- Asst. Dir.:
- Adm. Servs.
- Ident.
- Intell.
- Laboratory
- Legal Coun.
- Plan. & Insp.
- Rec. Mgmt.
- Tech. Servs.
- Training
- Public Affs. Off.
- Telephone Rm.
- Director's Sec'y

Handwritten initials and date: "11/21/78"

1947 A

Handwritten box with "5030 JEH" and "11/21/78"

DECLASSIFIED ON 4-1-81

NOV 28 1978

SFO619 3250854Z

OO HQ

FEDERAL BUREAU
OF INVESTIGATION
COMMUNICATIONS SECTION

DE SF 0021

O 210848Z NOV 78

FM SAN FRANCISCO (89-250 (P))

TO DIRECTOR IMMEDIATE

~~CONFIDENTIAL~~

BT

UNCLAS

~~RYMUR~~

*All paragraphs below unless otherwise indicated
are unclassified:*

ON NOVEMBER 19, 1978, SEVEN FORMER MEMBERS OF THE
PEOPLE'S TEMPLE (PT) WERE INTERVIEWED. SIX OF THESE PEOPLE
WERE MEMBERS OF THE PLANNING COMMISSION, THE "INNER CIRCLE"
OF THE PT. THEY FURNISHED THE FOLLOWING INFORMATION: (u)

REVEREND JAMES WARREN JONES, AKA JIM JONES, FOUNDER OF
THE PEOPLE'S TEMPLE CHRISTIAN CHURCH, DISCIPLES OF CHRIST,
FOUNDED THE CULT GROUP IN INDIANA IN THE LATE 1950S AND MOVED
WITH SOME OF HIS FOLLOWERS TO THE UKIAH, CALIFORNIA, AREA IN
APPROXIMATELY 1966, WHERE HE FOUNDED THE FIRST TEMPLE KNOWN
AS THE REDWOOD VALLEY TEMPLE ON EAST ROAD, REDWOOD VALLEY,
CALIFORNIA, NEAR UKIAH. SUBSEQUENT TEMPLES WERE ESTABLISHED
IN SAN FRANCISCO AT 1859 GEARY BOULEVARD, SAN FRANCISCO, AND

(u)
+
+
+

*Original filed as
89-4286-293*

~~CONFIDENTIAL~~

2

~~CONFIDENTIAL~~

PAGE TWO SF 89-250 UNCLAS

AT THE INTERSECTION OF HOOVER AND ALVARADO IN LOS ANGELES. THE ONLY TEMPLE NOW OPEN IS THE ONE IN SAN FRANCISCO (u)

MEMBERS OF THE PT WERE COERCED INTO MAKING WRITTEN STATEMENTS CONFESSING ILLEGAL AND IMMORAL ACTS SUCH AS VOWING TO KILL GOVERNMENT OFFICIALS WHICH WERE THEN PICKED UP AT OPEN MEETINGS OF THE TEMPLE BY THE PLANNING COMMISSION MEMBERS. THESE STATEMENTS WERE THEN DELIVERED TO THE REVEREND JONES, WHO USED THESE STATEMENTS TO INSURE THE MEMBERS INVOLVEMENT IN THE PT MOVEMENT. (u)

THERE ARE REPORTED PROGRAMS FOR THE COLLECTION AND CACHEING OF FIREARMS (HOWEVER, NONE OF THE INTERVIEWEES COULD GIVE SPECIFIC LOCATIONS FOR ANY OF THE CACHES, NOR HAD THEY SEEN ANY). MEMBERS ENGAGED IN FIREARMS TRAINING AND WERE THREATENED WITH ACTUAL ACTS OF VIOLENCE TO KEEP THEM IN LINE (u)

JONES URGED THE CREATION OF A PLAN WHICH WOULD GO INTO EFFECT IN THE EVENT OF HIS ARREST OR CAPTURE. THIS PLAN REPORTEDLY INSTRUCTED MEMBERS TO KIDNAP "PUBLIC OFFICIALS" AND THEN HOLD THEM HOSTAGE UNTIL JONES' RELEASE. ALSO, IF ANYONE ATTEMPTED TO EXPOSE THE PT OR PHYSICALLY INVADE IT, THE MEMBERS WERE INSTRUCTED TO KIDNAP PUBLIC OFFICIALS' CHILDREN, KILL THE

~~CONFIDENTIAL~~

~~CONFIDENTIAL~~

PAGE THREE SF 89-250 UNCLAS

CHILDREN, KILL THEIR OWN CHILDREN, AND THEN COMMIT SUICIDE. MURDER OF A PUBLIC OFFICIAL WAS ALSO CONDONED. IF A MEMBER LEFT THE MEMBERSHIP, THEIR LIVES COULD ALSO BE IN DANGER. (u)

ON NOVEMBER 19, 1978, DEPUTY CHIEF [REDACTED] SAN FRANCISCO PD, SPENT TWO AND ONE-HALF HOURS IN THE SAN FRANCISCO TEMPLE AND WAS ASKED IF HE DESIRED TO "LOOK AROUND", WHICH HE DID. HE SAW WEAPONS, BUT THE "SEARCH" WAS NOT A THOROUGH ONE. LATER IN THE EVENING, NOVEMBER 19, 1978, DISTRICT ATTORNEY AND CHIEF OF POLICE (COP) CHARLES GAIN ENTERED THE TEMPLE FOR A SHORT PERIOD OF TIME AND SAW NO WEAPONS. (u)

b6
b7c

ON NOVEMBER 20, 1978, SAC MC KINNON AND ASAC LAWLER MET WITH COP, SAN FRANCISCO, AND STAFF; DISTRICT ATTORNEY JOSEPH FREITAS AND STAFF; AND SECRET SERVICE SAC KENNETH IACOVONI AND STAFF TO EXCHANGE INFORMATION AND DISCUSS STRATEGY. (u)

NEITHER FBI, SAN FRANCISCO, OR THE LOCAL AUTHORITIES HAVE ANY CURRENT OR ACCURATE INFORMATION TO DEVELOP PROBABLE CAUSE FOR A SEARCH WARRANT OF THE TEMPLE. (u)

CONGRESSMAN RYAN'S OFFICE ADVISED THAT HIS BODY WOULD ARRIVE AT SAN FRANCISCO INTERNATIONAL AIRPORT (SFIA) VIA MILITARY PLANE AT 5:30 A.M., NOVEMBER 21, 1978, WHERE IT WILL BE MET BY (u)

~~CONFIDENTIAL~~

4

PAGE FOUR SF 89-250 UNCLAS

~~CONFIDENTIAL~~

AGENTS FOR THE PURPOSE OF INTERVIEWING ANY WITNESSES. CURRENT FUNERAL ARRANGEMENTS ARE FOR WEDNESDAY, NOVEMBER 22, 1978, AND BURIAL SCHEDULED FOR THE GOLDEN GATE NATIONAL CEMETARY, SAN BRUNO, CALIFORNIA (APPROXIMATELY 15 MILES SOUTH OF SAN FRANCISCO). SECRET SERVICE, SAN FRANCISCO, ADVISED THAT REPRESENTATIVES OF CAPITOL POLICE, WASHINGTON, D.C., WILL ARRIVE SAN FRANCISCO NOVEMBER 21, 1978, A.M., AND ASSIST LOCAL POLICE IN FUNERAL ARRANGEMENTS. THEY ADVISED THE CONGRESSIONAL CHARTER FROM WASHINGTON, D.C., WILL ARRIVE SFIA 10:00 A.M., NOVEMBER 22, 1978. ATTENDEES SCHEDULED TO STOP AT CROSBY AND GRAY FUNERAL HOME, BURLINGAME, CALIFORNIA, ALL SOULS CATHOLIC CHURCH, SOUTH SAN FRANCISCO, AND THEN TO CEMETARY. SUBSEQUENTLY SCHEDULED TO ATTEND RECEPTION AT AIRPORT HILTON HOTEL, SFIA. CONGRESSIONAL CHARTER SCHEDULED TO RETURN TO WASHINGTON, D.C., P.M., NOVEMBER 22, 1978. (u)

REGARDING A THREAT TO JOSEPH HOLSINGER, SON OF WILLIAM HOLSINGER, AID TO RYAN, IT HAS BEEN RESOLVED AS A LOCAL MATTER WITH NO KNOWN RAMIFICATIONS TO THIS CASE. (u)

DELTA AIRLINES PLANE RETURNING SEVEN PERSONS FROM GROUP TRAVELING WITH RYAN ARRIVED AT SFIA AT APPROXIMATELY 6:00 P.M., (u)

~~CONFIDENTIAL~~

~~CONFIDENTIAL~~

PAGE FIVE SF 89-250 UNCLAS

AND INTERVIEWS WERE CONDUCTED WITH THE FOLLOWING PEOPLE: (U)

GRACE STOEN, FEMALE WHITE, 28 YEARS, FORMER MEMBER WHO STAYED IN GEORGETOWN. (U)

JAMES COBB, JR., NEGRO MALE, 28 YEARS, FORMER MEMBER WHO WENT TO JONESTOWN. (U)

MICKEY TOUCHETTE, FEMALE WHITE, 27 YEARS, FORMER MEMBER WHO STAYED IN GEORGETOWN. (U)

CLARA BOUQUET, FEMALE WHITE, 50 YEARS, ONE OF THE ORGANIZERS OF THE CONCERNED RELATIVES, WHO STAYED IN GEORGETOWN. (U)

NADYNE LAUREL HOUSTON, FEMALE WHITE, 60 YEARS, MEMBER OF THE CONCERNED RELATIVES, WHO STAYED IN GEORGETOWN. (U)

WALTER WAYNE PIETILA, MALE WHITE, 25 YEARS, FORMER MEMBER WHO STAYED IN GEORGETOWN. (U)

BONNIE LOIS THIELMANN, FEMALE WHITE, 23 YEARS, FORMER MEMBER WHO STAYED IN GEORGETOWN. (U)

6 ALL OF THE ABOVE PERSONS WERE EXTREMELY TIRED UPON THEIR ARRIVAL, AND WHILE THE INTERVIEWS COVERED THE BASICS, FOLLOW-UP INTERVIEWS ARE PLANNED AT A TIME WHEN THEY ARE IN BETTER CONDITION (U)

[REDACTED] SUPPLIED THE BEST INSIGHT INTO THE ACTIVITIES, WHICH IS MUCH THE SAME AS THAT INFORMATION CONTAINED (U)

b6
b7c

~~CONFIDENTIAL~~

6

PAGE SIX SF 89-250 UNCLAS

~~CONFIDENTIAL~~

IN BALTIMORE'S TELETYPE TO THE DIRECTOR, DATED NOVEMBER 21, 1978.

[REDACTED] ADDS THE FOLLOWING NAMES OF THOSE PERSONS HE SAW ON THE TRAILER FROM WHERE THE SHOOTING CAME: (U)

BOB KICE, TOM KICE, JOE WILSON, ALBERT TOUCHETTE, EDDIE CRENSHAW, WESLEY (LNU), RON JAMES, AND RON TALLY. (U)

HE WITNESSED THE TWO KICES, WILSON, AND TOUCHETTE FIRE POINT BLANK AT FALLEN VICTIMS APPLYING THE COUP D'GRAS. HE BELIEVES THAT ONE OF THE LAST FOUR NAMES LISTED ABOVE WAS THE DRIVER OF THE TRACTOR WHICH PULLED THE ASSAULT TRAILER, BUT COULD NOT SEE THE ENTIRE ASSAULT TRAILER TO DETERMINE IF MORE PERSONS WERE RIDING THEREON. HE OBSERVED ONLY SHOTGUNS AND RIFLES USED AS WEAPONS. (U)

GRACE STOEN, WHO LEFT IN 1973, WAS, SHORTLY BEFORE HER LEAVING, IN CHARGE OF THE WEAPON INVENTORY AND STATED THAT AT THAT TIME THE GROUP HAD 176 VARIOUS WEAPONS, WHICH WERE EVENTUALLY BROUGHT TO THE PT IN SAN FRANCISCO AND THEN SHIPPED TO GUYANA BY UNKNOWN MEANS. (U)

[REDACTED] ADVISED THAT THE GROUP HAS A FISHING VESSEL IN GUYANA WHICH THEY USE TO SHIP GUNS. THE SPECIFIC DESCRIPTION OF THE VESSEL IS UNKNOWN. (U)

b6
b7c

~~CONFIDENTIAL~~

7

~~CONFIDENTIAL~~

PAGE SEVEN SF 89-250 UNCLAS

IN 1973, JONES TOLD HIM THAT IF ANYTHING HAPPENED TO JONES, HE WAS TO KILL JAMES COBB. (u)

[] HAD CONVERSATIONS PRIOR TO THE KILLING OF RYAN WITH THE SONS OF JIM JONES IN GEORGETOWN AND FELT BECAUSE OF THEIR ACTIONS AND STATEMENT "HUNDREDS OF LIVES ARE IN DANGER" THAT TROUBLE WOULD OCCUR. (u)

THE REMAINING INTERVIEWEES ALL HAD STAYED IN GEORGETOWN AND COULD FURNISH ONLY HEARSAY INFORMATION. (u)

[] STATED THAT THROUGH HIS ASSOCIATION WITH PT, HE IS AWARE THAT A NUMBER OF GUYANA OFFICIALS HAVE BEEN COMPROMISED BY JONES AND HIS ASSOCIATES THROUGH SEX AND/OR MONEY, AS WELL AS [] U.S. EMBASSY OFFICIAL IN GUYANA. ACCORDING TO [] WAS COMPROMISED BY [] UTILIZING SEX AND SHE HAS RECORDED TAPES OF THEIR AFFAIRS TO BE USED TO BLACKMAIL [] (u)

~~ALL INTERVIEWEES EXPRESSED EXTREME DISAPPOINTMENT IN THE LACK OF ASSISTANCE OFFERED BY THE AMERICAN AMBASSADOR, GUYANA, DURING ENTIRE STAY. BUREAU SHOULD BE AWARE THAT INTERVIEWEES WILL UNDOUBTEDLY MENTION TO THE PRESS THE LACK OF COOPERATION AND ASSISTANCE BY AMERICAN AMBASSADOR OF GUYANA. (u)~~

~~CONFIDENTIAL~~

b6
b7c

8

1

PAGE EIGHT SF 89-250 UNCLAS

~~CONFIDENTIAL~~

SAN FRANCISCO IS NOT IN POSSESSION OF ANY SPECIFIC INFORMATION WHICH RELATES TO ANY DANGER TO ANY DIGNITARIES ATTENDING RYAN'S FUNERAL. HOWEVER, THERE EXISTS A STATE OF PARANOIA AMONGST THE DEFECTORS, WHO FEAR RETALIATION. ALSO, THE EVENTS IN GUYANA INDICATE THE STATE OF MIND OF THE CURRENT MEMBERS OF THE PT. LOCAL POLICE WILL HAVE HEAVY SECURITY AT THE FUNERAL. (u)

SACRAMENTO OFFICE OBTAINED THE FOLLOWING DESCRIPTIVE DATA RE JIM JONES FROM CALIFORNIA CII, STATE DEPARTMENT OF JUSTICE, SACRAMENTO: (u)

JAMES WARREN JONES, WM, MAY 13, 1931, INDIANA, 5'10", 180 POUNDS, BLACK HAIR, BROWN EYES, CII NUMBER 5120912, LAPD NUMBER 1286450/J2 77007, CALIFORNIA DRIVER'S LICENSE NUMBER B423673, ARRESTS OR FINGERPRINTING - MARCH 24, 1964, APPLICANT PRINTS; DECEMBER 13, 1973, LAPD, LEWD CONDUCT (u)
BT

~~CONFIDENTIAL~~

9

005

MESSAGE RELAY VIA TELETYPE

Date 11-22-78

PRECEDENCE: IMMEDIATE
 PRIORITY
 ROUTINE

CLASSIFICATION: TOP SECRET
 SECRET
 CONFIDENTIAL
 UNCLASSIFIED

FIELD AND LEGAT MESSAGES
ONLY CLEAR EFTO

FM: DIRECTOR
TO: *[Handwritten signature]*

FEDERAL GOVERNMENT

ALL INFORMATION CONTAINED
HEREIN IS UNCLASSIFIED
DATE 9/17/92 BY 1048 DKM/ndm
284125
284126

- Attorney General
- Deputy Attorney General
 - Attn: Emergency Programs Center
- Assistant Attorney General, Civil Rights Div.
- Assistant Attorney General, Criminal Div.
 - Attn: Internal Security Section
 - Attn: General Crimes Section
- Immigration and Naturalization Service
- U. S. Marshal's Service
- U. S. Secret Service (PID)
- Director, CIA
- Secretary of State
- Department of Treasury
 - Attn: U. S. Customs
- Department of Treasury
 - Attn: Bureau of Alcohol Tobacco & Firearms

- Drug Enforcement Administration
- Energy Research and Development Administration
- U. S. Postal Service
- National Aeronautics & Space Adm.
- Department of Transportation
 - Attn: Director of Security
- Federal Aviation Administration
- Department of the Air Force (AFOSI)
- Department of the Army
- Naval Investigative Service
- National Security Agency (DIRNSA/NSOC (Attn: SOO))
- Commandant, U. S. Coast Guard
- Director, Defense Intelligence Agency

- The President
- White House Situation Room
 - Attn:
- The Vice President
 - Attn:

[Handwritten circled mark]

4286-100

REC-102

22 NOV 24 1978

(SUBJECT (TEXT BEGINS NEXT PAGE):

UNKNOWN SUBJECTS; CONGRESSMAN LEO J. RYAN (DECEASED) - VICTIM, CONGRESSIONAL ASSASSINATION STATUTE

Foreign Liaison Unit
 Route through for review
 Cleared telephonically
with _____

- Assoc. Dir. _____
- Dep. AD Adm. _____
- Dep. AD Inv. _____
- Asst. Dir.:
- Adm. Servs. _____
- Ident. _____
- Intell. _____
- Laboratory _____
- Legal Coun. _____
- Plan. & Insp. _____
- Rec. Mgmt. _____
- Servs. _____
- Training _____
- Off. Affs. _____
- Public Affs. _____
- Sec'y _____

ORIGINATOR KMR/pdh RM 554 5027 EXT 2805

211
NOV 28 1978
MAIL ROOM

0305 TR
[Handwritten initials]

[Handwritten signature]

SC0005 3252330Z

OO HI SF LA DL

DE SC

O 21224Z NOV 78

FM SACRAMENTO (89-191) (P)

TO DIRECTOR IMMEDIATE

SAN FRANCISCO (89-250) IMMEDIATE

LOS ANGELES IMMEDIATE

DALLAS IMMEDIATE

BT

UNCLAS

RMUR OO: SAN FRANCISCO

21 Nov 78 23 50 Z

FEDERAL BUREAU OF INVESTIGATION
COMMUNICATIONS SECTION

Assoc. Dir.	
Dep. AD Adm.	
Dep. AD Inv.	
Asst. Dir.:	
Adm. Serv.	
Crim. Inv.	
Ident.	
Intell.	
Laboratory	
Legal Coun.	
Plan. & Insp.	
Rec. Mgmt.	
Tech. Servs.	
Training	
Public Affs. Off.	
Telephone Rm.	
Director's Sec'y	

~~RE DALLAS AND SAN FRANCISCO TELETYPE, NOVEMBER 21, 1978.~~ (u)

ON NOVEMBER 20, 1978, ~~A SOURCE, FORMER MEMBER OF PEOPLES TEMPLE~~ CONTACTED THE

FRESNO, CALIFORNIA, RA, SC DIVISION, AND STATED HE WAS MEMBER OF [REDACTED] OF PEOPLE'S TEMPLE (PT) DURING YEARS [REDACTED]

SOURCE

[REDACTED] STATED HE HAD INFO RE PLANNED ASSASSINATIONS OF THE NATIONAL AND CALIFORNIA STATE LEADERS AS WELL AS OTHER DETAILS RE JONES OPERATION OF PT. [REDACTED] EXPRESSED FEAR OF

SOURCE

BEING KILLED BY JONES FOLLOWERS. (u)

SOURCE

[REDACTED] THEN CAME TO FBI OFFICE FRESNO AND FURNISHED (u)

b6
b7C
b7D

①-73) USSS
11/21-78
KMK

2

PAGE TWO SC 89-191 UNCLAS

FOLLOWING TO BUAGENT AND SA [REDACTED] USSS, FRESNO, CA. (U)

[REDACTED] AT [REDACTED]

[REDACTED] RESIDES AT

[REDACTED] PHONE [REDACTED]

HE IS

[REDACTED] (U)

SOURCE

IN 1972 WHILE LIVING IN [REDACTED]

HE HEARD JONES SPEAK ON RADIO AND AS HE WAS ONCE A [REDACTED]

[REDACTED] WAS ATTRACTED BY JONES' HUMANITARIANISM TO THE DOWNTRODDEN. HE APPROACHED JONES AND WAS SO IMPRESSED HE JOINED PT BRINGING HIS IMMEDIATE FAMILY, [REDACTED]

JONES TOLD HIM THAT AS A [REDACTED] HE COULD BE OF GREAT VALUE TO CHURCH AND THE CHURCH WOULD TAKE CARE OF HIM AND HIS FAMILY

FOREVER. [REDACTED] DONATED [REDACTED] OF REAL ESTATE TO JONES AS WELL AS OTHER PROPERTY. (U)

BECAUSE OF HIS ABILITIES AND DONATIONS, [REDACTED] WAS MADE HEAD OF THE [REDACTED] AND TAKEN INTO INNER COANCIL OF PT. THERE WERE NO SPECIFIC TITLES OF DEPARTMENTS, HEADS OR COUNCIL. (U)

[REDACTED] STATED THAT THE INNER COUNCIL CONSISTED OF FIFTY

(U)

b6
b7C
b7D

3

PAGE THREE SC 89-191 UNCLAS

TO ONE HUNDRED MEMBERS OF THE MOST FANATICAL FOLLOWERS OF JONES. JONES DEVELOPED INCREDIBLE CONTROL OVER THESE PEOPLE AND REGULARLY ADMINISTERED TESTS OF THEIR LOYALTY BY HAVING THEM DRINK A LIQUID PURPORTED TO BE POISON AND HAVING THEM SIGN NUMEROUS CONFESSIONS OF INCEST, CHILD ABUSE, OTHER CRIMES AS WELL AS STATEMENTS OF INTENT TO KILL THE PRESIDENT AND VICE-PRESIDENT, ETC. ACCORDING TO [REDACTED] JONES REPEATEDLY INSTRUCTED FOLLOWERS THAT THE GOVERNMENT AND "THE SYSTEM" WERE HIS ENEMIES AND THAT IN THE EVENT OF HIS DEMISE RETALIATION SHOULD BE IMMEDIATELY TAKEN IN THE FORM OF ASSASSINATION OF THE PRESIDENT AND ALL IN LINE OF SUCCESSION AS WELL AS STATE LEADERS, MAYOR MOSCONE OF SAN FRANCISCO, BOMBING OF POWER PLANTS, SPECIFICALLY RANCHO SECO NUCLEAR POWER PLANT NEAR SACRAMENTO.

b6
b7C
b7D

^{SOURCE}
[REDACTED] COULD NOT FURNISH SPECIFIC DETAILS OF ASSASSINATION PLOTS AND IT IS NOTED ^{SOURCE} [REDACTED] HAS NOT BEEN IN CONTACT WITH JONES OR PT DIRECTLY SINCE LATE 1974 WHEN HE WAS ABLE TO EXTRACT ENTIRE FAMILY FROM JONES CONTROL. HE SAID THIS EFFORT TOOK MONTHS OF CAREFUL PLANNING AS JONES KEPT FAMILY MEMBERS SEPARATED AND CLOSELY WATCHED. ^{SOURCE} [REDACTED] STATED HE IS CERTAIN SOME DEFECTORS WERE MURDERED BUT COULD NOT PROVIDE SPECIFICS AND WAS ONLY PRESENT DURING PLANNING OF ONE EXECUTION WHICH WAS NOT CARRIED OUT BECAUSE DEFECTOR, ARCHIE IJAMES, RETURNED

(u)

4

PAGE FOUR SC 89-191 UNCLAS

TO PT (U)
SOURCE

[] FURNISHED THE FOLLOWING AS PERSONS HE RECALLED AS BEING MEMBERS OF JONES INNER COUNCIL: (U)

(1) KAREN LAYTON, WF, AGE 30, 5'5", 120 POUNDS.

(2) CAROLYN LAYTON, WF, 35, 5'5", 115 POUNDS. CAROLYN LAYTON IS DESCRIBED AS VERY DANGEROUS. BOTH KAREN AND CAROLYN WERE AT DIFFERENT TIMES MARRIED TO LARRY LAYTON, IN CUSTODY IN GUYANA.

(3) TERRY BUFORD, WF, AGE 30, 5'8", 100 POUNDS, VERY THIN.

(4) MICHAEL PROKES, NEWS CORRESPONDENT, WM, 30 YEARS, 5'8", 145 POUNDS.

(5) EUGENE CHAIKEN (PH), WM, 5'8", 40 YEARS, 140 POUNDS, AN ATTORNEY.

RS (6) J. R. RANDOLPH, WM, 30-34 YEARS, 5'6", 130 POUNDS.

(7) ARCHIE IJAMES, NM, 64 YEARS, 6'2".

(8) JACK BEAM, WM, 55, STOCKY BUILD, 200 POUNDS, EXTREMELY VIOLENT.

(9) JIM MC ELVANE (PH), NM, 32-33, 6'2", 180 POUNDS.

SOURCE [] PERSONALLY WITNESSED NUMEROUS BEATINGS ON CHILDREN AND ADULTS. IN 1974, HE SAW JONES STRIP JOHN, SIX YEAR OLD SON OF GRACE STOEN, AND INSERT ELECTRIC PROD IN BOY'S RECT M AS

b6
b7C
b7D

(U)

(U)

S

PAGE FIVE SC 89-191 UNCLAS

PUNISHMENT. JONES WAS ALLEGEDLY FATHER OF THIS CHILD. (u)

THE DAY BEFORE THE EXPLOSION OF A MUNITIONS TRAIN AT EMORYVILLE, CA., ^{SOURCE} [] OVERHEARD JONES AT A MEETING MAKE STATEMENTS TO OTHER LIEUTENANTS TO THE EFFECT "MAKE SURE EVERYTHING IS IN PLACE WITH THAT MUNITIONS TRAIN AND DON'T BE SEEN". THE NEXT NIGHT AT A MEETING IN REDWOOD VALLEY, JONES ALLUDED TO THE EXPLOSION STATING "THE NEXT TIME THEY BRING ME BEFORE THE PRESS IT WILL BE BECAUSE OF A GREAT ACT OF JUSTICE LIKE THE MUNITIONS TRAIN LAST NIGHT. I DON'T CARE WHAT THEY SAY BUT ME AND MINE WERE THERE." (u)

JONES ALSO CLAIMED CREDIT FOR BOMBING OF PG&E POWER PLANTS IN SAN FRANCISCO BAY AREA, CLAIMED CONTACTS WITH MEMBERS OF NATION OF ISLAM, LCN, MOONIES, SYNANON, AND NUMEROUS GOVERNMENT OFFICIALS. ^{SOURCE} [] CLAIMS JONES TRAVELED TO EAST GERMANY, CUBA, SWITZERLAND. JONES PERSONAL WEALTH FROM INCOME FROM PT IS ESTIMATED AT BEING THIRTY TO FIFTY MILLION DOLLARS. TOTAL PT MEMBERSHIP IN 1974 ESTIMATED AT TWENTY TO THIRTY THOUSAND, ONE HUNDRED FIFTY OF THESE BEING HARD CORE FANATICS. (u)

^{SOURCE} [] REBUILT PT TEMPLE IN SAN FRANCISCO AFTER JONES BURNED STRUCTURE IN AN INSURANCE FRAUD. HE ALSO WENT TO GUYANA (u)

b6
b7C
b7D

b

PAGE SIX SC 89-191 UNCLAS

AND HELPED IN CONSTRUCTION OF THE COMPOUND. [REDACTED] STATED THAT HE BELIEVES MANY OF THE 1200 IN GUYANA WERE BEING HELD AGAINST THEIR WILL INCLUDING MANY MINOR CHILDREN WHO HAD BEEN TAKEN FROM THEIR PARENTS. (U)

SINCE HIS DEFECTION, [REDACTED] WAS VISITED ABOUT FOURTEEN MONTHS AGO BY CAROLYN LAYTON AND TWO MEN WHO PROMISED TO KILL HIM IF HE TALKED TO AUTHORITIES. (U)

[REDACTED] IDENTIFIED OTHER POSSIBLE DEFECTORS AS BEING DEANNA MYRTLE OF SAN FRANCISCO, JACK BEAM, JR., SON OF JACK BEAM, SUPRA, DEBBIE BLAKELY, INTERVIEWED ON NBC NEWS. (U)

[REDACTED] REQUESTED FEDERAL PROTECTION OR ASSISTANCE IN OBTAINING CONCEALED WEAPON PERMIT FROM SO. REQUESTS WERE DENIED BUT RAPPORT MAINTAINED. (U)

[REDACTED] CLAIMS TO HAVE BEEN CONTACTED ABOUT ONE AND TWO YEARS AGO AT FRESNO, CA., BY TWO FEDERAL AGENTS WHO WERE INTERESTED IN TAX STATUS OF ET. HE BELIEVES ONE WAS WITH IRS AND ONE WAS FBI. DETAILS OF THIS CONTACT VAGUE BUT HE CLAIMS MOST OF ABOVE WAS FURNISHED TO THESE AGENTS. SACRAMENTO INDICES NEGATIVE RE [REDACTED] INSISTED ON TAPING INTERVIEW. (U)

b6
b7C
b7D

7

PAGE SEVEN SC 89-191 UNCLAS

~~[] APPEARED ON LOCAL [] NEWS PROGRAMS~~

~~NOVEMBER 19 AND NOVEMBER 20, 1978. (U)~~

Source

Pass

~~[] APPEARS TO BE LEGITIMATE AND FULLY COOPERATIVE~~

~~BUT MEMORY OF DATES AND PLACES IS WEAK. FURTHER, HIS INFORMATION IS MOSTLY FOUR YEARS OLD. (U)~~

~~[] BEING RECONTACTED ON NOVEMBER 21, 1978. (U)~~

~~-REFERENCED-DALLAS-AND-SAN-FRANCISCO-TELETYPES- (U)~~

~~-BUREAU-IS-REQUESTED-TO-FURNISH-ABOVE-INFORMATION-TO-~~

~~U.S. SECRET SERVICE, WASHINGTON, D.C. (U)~~

~~SAN-FRANCISCO AND SACRAMENTO WILL INSURE APPROPRIATE STATE,~~

~~CITY AND UTILITY OFFICIALS ADVISED OF THREATS. (U)~~

BT

b6
b7C
b7D

8

FEDERAL BUREAU OF INVESTIGATION
FOIPA
DELETED PAGE INFORMATION SHEET

No Duplication Fees are charged for Deleted Page Information Sheet(s).

Total Deleted Page(s) ~ 71

Page 227 ~ Referral/Consult
Page 228 ~ Referral/Consult
Page 229 ~ Referral/Consult
Page 230 ~ Referral/Consult
Page 231 ~ Referral/Consult
Page 232 ~ Referral/Consult
Page 233 ~ Referral/Consult
Page 234 ~ Referral/Consult
Page 235 ~ Referral/Consult
Page 236 ~ Referral/Consult
Page 237 ~ Referral/Consult
Page 238 ~ Referral/Consult
Page 239 ~ Referral/Consult
Page 240 ~ Referral/Consult
Page 241 ~ Referral/Consult
Page 242 ~ Referral/Consult
Page 243 ~ Referral/Consult
Page 244 ~ Referral/Consult
Page 245 ~ Referral/Consult
Page 246 ~ Referral/Consult
Page 247 ~ Referral/Consult
Page 248 ~ Referral/Consult
Page 249 ~ Referral/Consult
Page 250 ~ Referral/Consult
Page 251 ~ Referral/Consult
Page 252 ~ Referral/Consult
Page 253 ~ Referral/Consult
Page 254 ~ Referral/Consult
Page 255 ~ Referral/Consult
Page 256 ~ Referral/Consult
Page 257 ~ Referral/Consult
Page 258 ~ Referral/Consult
Page 259 ~ Referral/Consult
Page 260 ~ Referral/Consult
Page 261 ~ Referral/Consult
Page 262 ~ Referral/Consult
Page 263 ~ Referral/Consult
Page 264 ~ Referral/Consult
Page 265 ~ Referral/Consult
Page 266 ~ Referral/Consult
Page 267 ~ Referral/Consult
Page 268 ~ Referral/Consult
Page 269 ~ Referral/Consult
Page 270 ~ Referral/Consult

Page 271 ~ Referral/Consult
Page 272 ~ Referral/Consult
Page 273 ~ Referral/Consult
Page 274 ~ Referral/Consult
Page 275 ~ Referral/Consult
Page 276 ~ Referral/Consult
Page 277 ~ Referral/Consult
Page 278 ~ Referral/Consult
Page 279 ~ Referral/Consult
Page 280 ~ Referral/Consult
Page 281 ~ Referral/Consult
Page 302 ~ Referral/Consult
Page 303 ~ Referral/Consult
Page 304 ~ Referral/Consult
Page 305 ~ Referral/Consult
Page 306 ~ Referral/Consult
Page 307 ~ Referral/Consult
Page 308 ~ Referral/Consult
Page 314 ~ Referral/Consult
Page 315 ~ Referral/Consult
Page 316 ~ Referral/Consult
Page 317 ~ Referral/Consult
Page 318 ~ Referral/Consult
Page 319 ~ Referral/Consult
Page 320 ~ Referral/Consult
Page 321 ~ Referral/Consult
Page 322 ~ Referral/Consult