

89- HQ-4286

SECTION 5

SERIALS 384-497

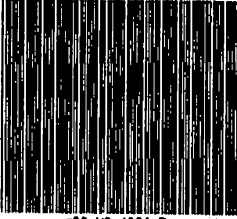

89-HQ-4286-34

U. S. DEPARTMENT OF JUSTICE

(MATERIAL MUST NOT BE REMOVED FROM OR ADDED TO THIS FILE)

ALL INFORMATION CONTAINED
HEREIN IS UNCLASSIFIED
DATE 11/25/82 BY 1048 DKM/ndm
284,125 #
284,126

FEDERAL BUREAU

of

INVESTIGATION

~~RECEIVED~~
~~FBI~~

USE CARE IN HANDLING THIS FILE

Transfer - Call 3421

SECTION 5

SERIALS 384--497

MI0001 3300350

PP HQ SF

DE MI

P 250350Z NOV 78

FM MILWAUKEE (89-120)P

TO DIRECTOR (89-4286) PRIORITY

SAN FRANCISCO PRIORITY

BT

UNCLAS
RY MUR.

26 Nov 78 04 121
RECEIVED
FEDERAL BUREAU
OF INVESTIGATION
COMMUNICATIONS SECTION

ALL INFORMATION CONTAINED
HEREIN IS UNCLASSIFIED
DATE 9/24/92 BY 1046 DKA/ude
#294,125 \$
#294,126 \$

Assoc. Dir.	
Dep. AD Adm.	
Dep. AD Inv.	
Asst. Dir.:	
Adm. Serv.	<input checked="" type="checkbox"/>
Crim. Inv.	<input checked="" type="checkbox"/>
Ident.	
Intell.	
Laboratory	
Legal Coun.	
Plan. & Insp.	
Rec. Mgmt.	
Tech. Servs.	
Training	
Public Affs. Off.	
Telephone Rm.	
Director's Sec'y	

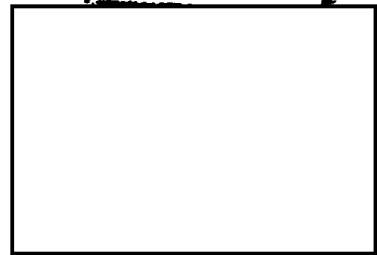

b6
b7c

RE MINNEAPOLIS TEL TO MILWAUKEE 11/25/78.

[REDACTED] BALDWIN, WISCONSIN, AN AMATEUR RADIO OPERATOR, CALL LETTERS [REDACTED] CONTACTED AND ADVISED THAT ON 3/17/78 BETWEEN THE HOURS OF 12:30AM AND 3:00AM CST, HE MONITORED MEDICAL TRAFFIC BETWEEN JONESTOWN, GUYANA, S.A., RADIO CALL LETTERS W6S MID/8R3 AND WHAT HE RECALLS AS EITHER WH OR K4 ABC OR POSSIBLY ADC LOCATED IN WASHINGTON D.C. (u)

REC-102 89-4286-384

THE TRAFFIC APPEARED TO BE BETWEEN AN M.D. OR A MEDICAL TECHNICIAN IN JONESTOWN AND A PERSON IN WASHINGTON D.C. WHO MADE HOSPITAL PHONE PATCHES. JONESTOWN APPEARED TO BE HAVING A MEDICAL PROBLEM (u)

NOV 28 1978

lg

58 NOV 29 1978

PAGE TWO MILWAUKEE 89-120 UNCLAS

CONCERNING PREGNANCY COMPLICATIONS. NUMEROUS MENTIONS OF A DR. JORDAN IN THE U.S. OCCURRED DURING THE TRAFFIC AND JORDAN COULD POSSIBLY BE AN EXPERT IN CESAREAN BIRTH. (u)

DURING A BREAK IN THE MEDICAL TRAFFIC JONESTOWN STATED THAT CONTACT WITH THEM COULD BE MADE ON WB6 MID/8R3. [] CALLED JONESTOWN AND TALKED WITH EITHER JIM OR AL FOR FIVE MINUTES. [] RECORDED THE RECEIVING TRAFFIC FROM JONESTOWN AND TRAFFIC DESCRIBES JONESTOWN AS BEING A FREE MEDICAL CLINIC AN AGRICULTURAL PROJECT, A PLACE WITH A RELAXED ATMOSPHERE, A SECOND CHANCE FOR PEOPLE WHO ARE FAILURES IN AMERICAN SOCIETY. TRAFFIC STATED THAT IN JONESTOWN PEACE AND A SENSE OF PURPOSE WAS HELPING MANY PEOPLE WHO WERE FORMER DRUG ADDICTS, EX-CONS, AND PEOPLE WITH PROBLEMS. TRAFFIC ALSO STATED NUMEROUS OCCUPATIONAL, RECREATIONAL, AND EDUCATIONAL OPPURTUNITIES EXISTED AT JONESTOWN. (u)

b6
b7c

AFTER APPROXIMATELY FIVE MINUTES THERE WAS A BREAK AND

[] RIVER FALLS, WISCONSIN BROKE IN. (u)

[] ADVISED [] HAS HAD CONTACT WITH JONESTOWN ON SEVERAL (u)

2

PAGE THREE MILWAUKEE 89-120

OCCASSIONS CONCERNING AGRICULTURAL ENDEAVORS. [] IS AN INSTRUCTOR AT THE UNIVERSITY OF WISCONSIN-RIVER FALLS, AN AGRICULTURAL SCHOOL. (u)

[] SENT A ONE DOLLAR CONTRIBUTION ALONG WITH HIS QSL (CAN YOU ACKNOWLEDGE RECEIPT) CARD TO WB6 MID/8R3, JONESTOWN IN MARCH, 1978. IN AUGUST 1978 [] RECEIVED 3 QSL CARDS FROM JONESTOWN ACKNOWLEDGING THE CONTRIBUTION AND A SHORT TYPED MESSAGE. ALL WERE SIGNED AL (ALBERT TOUCHETTE). ONE QSL CARD BARES PICTURES OF THREE INDIVIDUALS WHOM POSSIBLY COULD BE IDENTIFIED.

b6
b7c

RADIO CALL LETTERS WB6 MID IS LISTED TO ALBERT A. TOUCHETTE, 3747 RD. -B-REDWOOD, CALIFORNIA. (u)

[] TURNED OVER TO THE FBI A TAPE RECORDING OF APPROXIMATELY 1 AND 1/2 MINUTES OF THE MEDICAL TRAFFIC AND ALL OF HIS TRAFFIC WITH JONESTOWN WHICH TOOK PLACE ON 3/17/78 AND TWO OF THE QSL CARDS HE HAD RECEIVED FROM AL. (u)

ON 11/25/78 ATTEMPT WAS MADE TO CONTACT [] AT RIVER FALLS, WISCONSIN, HOWEVER NO ONE WAS AT HOME.

FD 302'S TO FOLLOW. (u)

ARMED AND DANGEROUS. SUICIDAL TENDENCIES. (u)

BT

3

LA0581 3302345Z

PP HQ SF

DE LA

P 252345Z NOV 78

FM LOS ANGELES (89-436)

TO DIRECTOR (89-4286) (PRIORITY)

SAN FRANCISCO (89-250) (PRIORITY) (SF VIA FBIHQ)

26 Nov 78 00 16z

REC'D
FEDERAL BUREAU
OF INVESTIGATION
COMMUNICATIONS SECTION

ALL INFORMATION CONTAINED
HEREIN IS UNCLASSIFIED
DATE 9/24/92 BY 1048 DVM/judy

Assoc. Dir.	
Dep. AD Adm.	
Dep. AD Inv.	
Asst. Dir.:	
Adm. Serv.	
Crim. Inv.	<input checked="" type="checkbox"/>
Ident.	
Intell.	
Laboratory	
Legal Coun.	
Plan. & Insp.	
Rec. Mgnt.	
Tech. Servs.	
Training	
Public Affs. Off.	
Telephone Rm.	
Director's Sec'y	

BT

UNCLAS
RYMUR

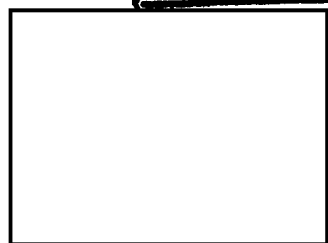

RE SAN FRANCISCO TELETYPE TO BUREAU DATED 11-25-78 (u)

TELEPHONE NUMBER [redacted] LISTED TO [redacted]

[redacted] HUNTINGTON BEACH,
CALIFORNIA, BORN [redacted] (u)

ON 11-25-78 BUREAU AGENTS LOCATED AND INTERVIEWED

[redacted] ROOMMATE OF [redacted] WHO ADMITTED MAKING
TELEPHONE CALLS TO BERKLEY, CALIFORNIA PD RE PEOPLES TEMPLE.

[redacted] STATED HE HAS ASSOCIATED WITH MEMBERS OF THE PEOPLES
TEMPLE DURING 1960'S BUT WAS NOT A MEMBER. [redacted] STATED HE WAS AN ACQUAINTANCE OF JIMMIE JONES SON. STATED IF M-16 RIFLES USED IN GUYANA INCIDENT THEY MAY HAVE BEEN TAKEN WITHIN PAST SIX MONTHS FROM A SOUTHERN CALIFORNIA ARMORY. [redacted] STATED HE HAS NO INFORMATION RELATIVE TO SPECIFIC ACTS OF TERRORISM, OR PLANS FOR SUCH

REC-102

89-4286-385

NOV 23 1978

RECEIVED TO:
SF
58 NOV 29 1978

0-73 sent to Columbia & USSS
JPR/PCM, 11-25-78.

(u)
X
(u)

b6
b7c

PAGE TWO LA 89-436

ACTS. [] COULD PROVIDE NO INFORMATION REGARDING MEMBERS OF "HIT SQUADS" OR IF THEY IN FACT EXIST. [] DESIRED TO TALK TO HIS ATTORNEY PRIOR TO OFFERING ANY FURTHER INFORMATION. HE WAS GIVEN NAMES AND OFFICE TELEPHONE NUMBERS OF INTERVIEWING AGENTS. (u)

[] ADMITTED A LONG HISTORY OF DRUG USE, AND DURING INTERVIEW WAS "HIGHLY EXCITED". [] STATED HE MADE TELEPHONE CALLS BECAUSE A FRIEND WAS IN GUYANA AND HE DID NOT KNOW THE FATE OF HIS FRIEND. [] WOULD NOT PROVIDE FRIENDS NAME. (u)

b6
b7c

[] APPARENTLY IDENTICAL WITH [] FBI NUMBER [] BORN [] BROWN AND BROWN. (u)

ARMED AND DANGEROUS; SUICIDAL TENDENCIES (u)

BT

2

SFO 79 7 329011Z

Assoc. Dir.	_____
Dep. AD Adm.	_____
Dep. AD Inv.	_____
Asst. Dir.:	_____
Adm. Serv.	<u>M 9A</u>
Crim. Inv.	<u>L</u>
Ident.	_____
Int'l.	_____
Laboratory	_____
Legal Coun.	_____
Plan. & Insp.	_____
Rec. Mgmt.	_____
Tech. Servs.	_____
Training	_____
Public Affs. Off.	_____
Telephone Rm.	_____
Director's Sec'y	_____

OO HQ BT

26 Nov 78 01 19z

DE SF 006

FEDERAL BUREAU
OF INVESTIGATION
COMMUNICATIONS SECTION

O 20109Z NOV 7

FM SAN FRANCISCO (89-250) (P) (SQUAD 10)

TO DIRECTOR, FBI (89-4286) IMMEDIATE

ATTN: CID COMMAND POST

BALTIMORE (89-173) IMMEDIATE

BT

UNCLAS E F T O

RYMUR

ALL INFORMATION CONTAINED
HEREIN IS UNCLASSIFIED
DATE 12/2/92 BY 1048 DKM/udm

cc - IDENT
(DISASTER SQUAD)

b6
b7c

RE SAN FRANCISCO TELCALL TO BALTIMORE NOVEMBER 25, 1978. (u)

CONCLUSION OF FINGERPRINT CARDS, DRIVERS LICENSES AND
BACKGROUND DATA OBTAINED FROM CII BY SACRAMENTO OFFICE WILL BE
PLACED ON UNITED AIR LINES (UAL) FLIGHT 76 DEPARTING SAN
FRANCISCO INT'L AIRPORT 11:05 PM, (FLIGHT CHANGES TO UAL 966

AT CLEVELAND) ARRIVING BALTIMORE FRIENDSHIP ON UAL FLIGHT 966
11:00 AM ON NOVEMBER 26, 1978. PACKAGE ADDRESSED TO SAC

BALTIMORE AND SHIPPED SPECIAL COURIER, SMALL PACKAGE "LAST
ON - FIRST OFF" UAL CARGO. (u)

REC-102 89-4286-386

23 NOV 28 1978

BALTIMORE INSURE BUREAU AGENT MEET UAL FLIGHT 966 TO
OBTAIN PACKAGE DESTINED FOR BUREAU DISASTER, DOVER, MARYLAND. (u)

ARMED AND DANGEROUS; SUICIDAL TENDENCIES. (u)

BT

RTS

58 NOV 30 1978

025

DEPARTMENT OF JUSTICE
FEDERAL BUREAU OF INVESTIGATION
COMMUNICATION MESSAGE FORM

0
7110
A
P

PAGE 1 OF 2

DATE 11/26/78	CLASSIFICATION UNCLAS	PRECEDENCE PRIORITY
------------------	--------------------------	------------------------

✠SSTY160**SSTPP Y160Y23 H0025 33021550YU0P 262110Z NOV 78

▶ START HERE

FM DIRECTOR FBI
TO Y16/U.S. SECRET SERVICE
Y15/FBI SAN FRANCISCO PRIORITY
Y15/FBI ST. LOUIS PRIORITY

ALL INFORMATION CONTAINED
HEREIN IS UNCLASSIFIED
DATE 9/24/92 BY 6018 OKM/udm

FEDERAL GOVERNMENT

BT

UNCLAS

RYMUR.

REFERENCE BUREAU TELEPHONE CALL TO SAN FRANCISCO
NOVEMBER 26, 1978.

FOR INFORMATION ST. LOUIS, LAWRENCE JOHN LAYTON, WHITE
MALE, BORN JANUARY 11, 1946, AT GREENBELT, MARYLAND, AND
CHARLES EDWARD BEIKMAN, BORN AUGUST 13, 1935, U.S. PASSPORT
NUMBER E196101, WERE ARRESTED BY THE POLICE OF GUYANA.
LAYTON IS CHARGED IN THE SHOOTING INVOLVING THE DEATH OF
CONGRESSMAN LEO J. RYAN. BEIKMAN IS CHARGED WITH THE MURDERS
OF SHARON AMOS AND HER THREE CHILDREN AT GEORGETOWN, GUYANA.
AMOS WAS A PEOPLES TEMPLE MEMBER. SHE AND HER CHILDREN WERE.

DO NOT TYPE MESSAGE BELOW THIS LINE

DO NOT TYPE PAST THIS LINE

APPROVED BY DWM/LFS	DRAFTED BY LFS/CAW	DATE 11/26/78	ROOM 5015/6	TELE EXT 4190
------------------------	-----------------------	------------------	----------------	------------------

- 1 - MR. GOW
- 1 - MR. WOOD
- 1 - MR. []

DE-5
REC-102
SEE NOTE PAGE 3
FEDERAL BUREAU OF INVESTIGATION
COMMUNICATIONS SECTION

89-4286-387

NOV 28 1978

NOV 26 1978

Handwritten signature/initials

58 NOV 29 1978

DEPARTMENT OF JUSTICE
 FEDERAL BUREAU OF INVESTIGATION
 COMMUNICATION MESSAGE FORM

PAGE 2

CONTINUATION SHEET

PAGEARTWOREDE HQ 0025 UNCLAS ***PAGE TWO DE RUEHFB 0025 UNCLAS

FOUND WITH THEIR THROATS SLASHED SHORTLY AFTER THE DISCOVERY
 20 OF THE MASS SUICIDE VICTIMS AT JONESTOWN, GUYANA. (u)

18 BUREAU INDICES, NCIC, AND IDENTIFICATION DIVISION FILES
 ARE NEGATIVE ON THE ABOVE, AS ARE INDICES IN INDIANAPOLIS,
 16 SAN FRANCISCO, SACRAMENTO, LOS ANGELES, AND SAN DIEGO.

CALIFORNIA LAW ENFORCEMENT TELETYPE SYSTEM ALSO NEGATIVE RE
 14 ABOVE NAMES. (u)

INFORMATION FROM POLICE OF GUYANA INDICATED BEIKMAN IS
 12 EX-MILITARY. (u)

ST. LOUIS SHOULD CHECK MILITARY RECORDS RE BEIKMAN AND
 10 LAYTON. SHOULD RECORDS BE LOCATED, PROVIDE DETAILED REVIEW
 IN A DISSEMINATEABLE TELETYPE. (u)

8 SAN FRANCISCO SHOULD CONDUCT BACKGROUND INVESTIGATION OF
 LAYTON AND BEIKMAN TO SERVICE THE REQUEST OF THE POLICE OF
 6 GUYANA FOR THIS INFORMATION AS A FOREIGN POLICE COOPERATION
 MATTER AND IN VIEW OF INTEREST IN LAYTON REGARDING HIS ALLEGED
 4 INVOLVEMENT IN THE DEATH OF CONGRESSMAN RYAN. (u)

BT

2

DO NOT TYPE PAST THIS LINE

DO NOT TYPE MESSAGE BELOW THIS LINE

Q Q

PAGE THREE

NOTE: ABOVE INSTRUCTS ST. LOUIS AND SAN FRANCISCO TO CONDUCT INVESTIGATION TO FURTHER IDENTIFY AND DEVELOP BACKGROUND ON LARRY LAYTON CHARGED WITH THE MURDER OF CONGRESSMAN RYAN AND CHARLES BEIKMAN CHARGED WITH THE MURDERS OF SHARON AMOS {PEOPLES TEMPLE MEMBER} AND HER CHILDREN IN GEORGETOWN, GUYANA. REQUEST MADE THROUGH LEGAT, CARACAS BY POLICE OF GUYANA FOR THIS INFORMATION.

(u)

3

023

MESSAGE RELAY VIA TELETYPE

DATE 11/26/78	CLASSIFICATION CONFIDENTIAL	PRECEDENCE IMMEDIATE
------------------	---	-------------------------

FM DIRECTOR FBI

TO SACS, Baltimore
Columbia
San Francisco

DECLASSIFIED BY 10480/KM/UDA
ON 9/24/92
#284,125 #284,126

- The President
- The Vice President
- White House Situation Room
- Attn: National Security Council
- Department of the Air Force (AFOSI)
- Department of the Army
- Naval Investigative Service
- Commandant, U. S. Coast Guard
- National Security Agency (DIRNSA/NSOC (ATTN: SOO))
- Director, Defense Intelligence Agency
- Director CIA
- U. S. Secret Service (PID)
 - Attn: Executive Protective Service
- ZEN/U. S. Postal Service
 - Attn: Chief Postal Inspector
- Nuclear Regulatory Commission
- Department of Energy
- Department of Treasury
 - Attn: U. S. Customs
- Department of Treasury
 - Attn: Bureau of Alcohol Tobacco & Firearms
- Department of Transportation
 - Attn: Director of Security
- Drug Enforcement Administration
- General Services Administration (WASHDC area, specify office)
- (Other Areas, specify CITY/STATE)
- Federal Aviation Administration
- Federal Protective Service
- Secretary of State
 - Attn: Director Bureau of Intelligence & Research
 - Attn: SCA - VISA Office Room 709 - SA2
- Attorney General
 - Deputy AG
 - Attn: Emergency Programs Center
 - Assistant AG, Civil Rights Div.
 - Assistant AG, Criminal Div.
 - Attn: Internal Security Section
 - Attn: General Crimes Section
 - Assistant AG for Administration
 - Attn: Security & Administrative Services Staff
 - Immigration & Naturalization Service

9/24/92

(SERVICE ALSO AVAILABLE TO GOVERNMENT AGENCIES NOT LISTED. CONTACT COMMUNICATIONS CENTER FOR ADDRESSING INFORMATION)

SUBJECT: UNSUBS, CONGRESSMAN LEO J. RYAN - VICTIM, CAS, ETC.

Rymur

REC-102

89-4286-388

APPROVED BY DWM/LFS	ORIGINATOR	ROOM 5015	TELE EXT. 4190
------------------------	------------	--------------	-------------------

NOV 28 1978

NOV 26 1978
NK 23:3

58 NOV 21 9 1978

DO NOT FILE WITHOUT COMMUNICATIONS STAMP

USE OF FORM 0-73

- 36 Nov 78 11 08
FEDERAL BUREAU OF INVESTIGATION COMMUNICATIONS SECTION
1. Only incoming teletype messages which require transmission relay may be prepared for transmission using form 0-73. Use of form 0-73 is restricted to incoming teletype messages received within the last 3 days which require transmission relay; all other teletype messages must be prepared using form 0-93.
 2. Additions such as notes and administrative data for a particular addressee are not allowed. If a note or administrative data is required for a particular addressee a separate 0-73 form must be prepared.
 3. The message will be transmitted just as it appears. The person approving the message is solely responsible for assuring all necessary editing changes have been made.

PREPARATION OF FORM WHICH CONSISTS OF A PREPRINTED YELLOW.

1. Complete appropriate boxes: date, classification & precedence.
2. List addresses immediately following the "TO" or place a check mark in the appropriate boxes.
3. Type or PRINT the subject in the space provided.
4. Print or type originator's name, room number and telephone extension.
5. Indicate approval for transmission by initialing the "Approved By" box.

PREPARATION OF MESSAGE TO BE TRANSMITTED

1. Xerox 1 copy of incoming teletype message. A notation shall be made on the original incoming teletype "1 copy made for relay to SACS _____, (OR LEGATS) _____, (OR GOVERNMENT AGENCIES) _____."
2. Minor editing changes shall be made on the xerox as follows: using a lead pencil ONLY draw single line through the first and last lines of the heading and connect these lines from top right to bottom left forming a "Z," figure. (DO NOT OBLITERATE THE HEADING.) Use horizontal lines to delete sentences or words. Printed changes of a word or two to the text of the message may be made; however, changes to the existing text involving more than a word or two necessitate the originator to initiate a new message using form 0-93.
3. Administrative data or notes may be typed immediately following the text and will be transmitted to all addressees.
4. When using the 0-73 form to disseminate information to field offices, Legal Attaches and other Government agencies simultaneously, the text, notes and administrative data must be identical for all addressees.

LFO 793 3290 023Z

OO HQ

DE SF 03

O 250015Z NOV 78

FM SAN FRANCISCO (8-250) (P) (SQUAD 10)

TO DIRECTOR, FBI (8-4286) IMMEDIATE

ATTN: CID COMMAND POST

BT

UNCLAS E F T O

RYMUR

26 Nov 78 00 45z

FEDERAL BUREAU OF INVESTIGATION COMMUNICATIONS SECTION

Assoc. Dir.	_____
Dep. AD Adm.	_____
Dep. AD Inv.	_____
Asst. Dir.:	_____
Adm. Serv.	_____
Crim. Inv.	_____
Ident.	_____
Intell.	_____
Laboratory	_____
Legal Coun.	_____
Plan. & Insp.	_____
Rec. Mgmt.	_____
Tech. Servs.	_____
Training	_____
Public Affs. Off.	_____
Telephone Rm.	_____
Director's Sec'y	_____

ALL INFORMATION CONTAINED
HEREIN IS UNCLASSIFIED
DATE 4/24/52 BY [signature]



b6
b7C

SAN FRANCISCO IS ANALYZING THE INFORMATION WHICH HAS COME TO OUR ATTENTION THUS FAR WHICH MAY INDICATE THAT A CONSPIRACY EXISTED. THIS ANALYSIS IS BEING DONE FOR A DUAL PURPOSE. FIRST TO DETERMINE WHAT LEADS ARE NECESSARY AND IN WHICH DIRECTION THE INVESTIGATION SHOULD GO IN ORDER TO SHOW THIS CONSPIRACY.

SECOND, THERE APPARENTLY IS A JURISDICTIONAL DISPUTE ON VENUE BASED UPON THE FEDERAL RULES OF CRIMINAL PROCEDURE WHICH

INDICATE THAT JURISDICTION WILL LIE WHEREVER THE PARTIES TO BE TRIED FIRST ENTER THE UNITED STATES. CONSEQUENTLY, THE DISPUTE AS TO WHETHER THIS CASE SHOULD BE TRIED IN THE NORTHERN DISTRICT

OF CALIFORNIA OR IN THE DISTRICT IN WHICH CHARLESTON, SOUTH CAROLINA LIES MAY EXIST IF ANY OF THE PERSONS FOR WHOM WARRANTS ARE OUTSTANDING ENTER THE UNITED STATES IN THE FIRST PLANE

LOADS OUT OF GUYANA AND LANDING AT CHARLESTON, SOUTH CAROLINA.

HOWEVER, IF A CONSPIRACY WITH ROOTS IN SAN FRANCISCO CAN BE SHOWN VENUE WILL LIE IN THE NDC. (u)

(Handwritten initials)

REC-102 89-4286-389

NOV 23 1978

58 NOV 29 1978 -73 sent to Columbia, Memphis, San Juan, JPR/DCM, 11-25-78.

PAGE TWO SF 89-250 UNCLAS E F T O

THE BELOW INFORMATION ARE POINTS, SOME STRONG, SOME WEAK, WHICH MAY TEND TO SHOW A CONSPIRACY ROOTED IN THE UNITED STATES OR SPECIFICALLY IN SAN FRANCISCO. SAN FRANCISCO IS AWARE THAT THE CONSPIRACY MUST RELATE TO THE ASSASSINATION OF CONGRESSMAN RYAN AND CONGRESSMAN RYAN ALONE. THAT IS TO SAY, THAT IF A CONSPIRACY EXISTED IN GENERAL TO ASSASSINATE ANYONE WHO CAME DOWN TO GUYANA TO EXPOSE THE PEOPLE'S TEMPLE (PT) THE EXTRA TERRITORIAL PORTION OF THE STATUTE WOULD NOT APPLY. IT MUST SHOW, THEREFORE, THAT THE CONSPIRACY RELATES SPECIFICALLY TO CONGRESSMAN RYAN (u)

CHARLES GARRY, PT ATTORNEY, ADVISED THAT TERRI BUFORD WHO INTERVIEWS INDICATE IS A HIGH FUNCTIONARY IN THE PT AND WHICH INTERVIEWS ALSO INDICATE SHOULD BE CONSIDERED AS ONE OF THE TWO MOST DANGEROUS MEMBERS IN THE UNITED STATES, DEFECTED FROM THE PT APPROXIMATELY TWO WEEKS BEFORE RYAN'S MURDER. SHE IS IN HIDING AND IN FEAR OF HER LIFE. ACCORDING TO GARRY HER WHEREABOUTS ARE KNOWN BY MARK LANE. (u)

FOUR MEMBERS OF THE PT, CHARLES TOUCHETTE, HELEN SWINNEY, RICHARD JANERO, AND PHILIP BLAKEY LEFT GUYANA VIA A BOAT OWNED (u)

2

PAGE THREE SF 89-250 UNCLAS E F T O

BY THE PT AND ARE IN TRINIDAD, PORT OF SPAIN. THESE PEOPLE HAVE BEEN IDENTIFIED BY EX-MEMBERS AS HIGH FUNCTIONARIES IN THE PT.

NEWS ACCOUNTS INDICATE ANOTHER BOAT OWNED BY THE PT, THE MARCELINE, IS MISSING. (u)

WHILE SAN FRANCISCO HAS NO SPECIFIC KNOWLEDGE THESE ITEMS ARE RELATED TO A CONSPIRACY, THE COINCIDENCE OF THESE PURPORTEDLY LOYAL MEMBERS AND HIGH FUNCTIONARIES OF THE PT LEAVING JUST PRIOR TO RYAN'S MURDER, CANNOT BE OVERLOOKED. (u)

NUMEROUS HAM OPERATORS HAVE INFORMED US THAT THE PT IN GUYANA AND THE PT IN SAN FRANCISCO WERE IN FREQUENT RADIO CONTACT WITH EACH OTHER ON A CONTINUING BASIS. AN AIR FORCE SERGEANT ADVISED THE NORFOLK FBI THAT ON SEPTEMBER 11, 1977, THAT HE MONITORED BROADCASTS, ONE OF WHICH SEEMS IMPORTANT. IT WAS THE MONITOR'S OPINION OF THE SPECIFIC BROADCAST THAT THE CONVERSATION DEALT WITH A CONSPIRACY OF SOME SORT AND INVOLVED A CHARTERED AIRLINE FLIGHT IN WHICH SOMETHING MIGHT HAPPEN TO THE AIRCRAFT. (u)

ACCORDING TO [REDACTED] AIDE TO RYAN, RYAN BEGAN FORMULATING PLANS TO VISIT JONESTOWN IN THE EARLY SUMMER, 1978. (u)

b6
b7c

2

PAGE FOUR SF 89-250 UNCLAS E F T O

THIS WOULD GIVE SUFFICIENT TIME FOR THE CONSPIRACY TO BE HATCHED J4

EX-MEMBERS AL AND JEAN MILLS ADVISE THAT TIM CARTER APPEARED AT THE HUMAN FREEDOM CENTER TWO OR THREE WEEKS PRIOR TO RYAN'S PLANNED DEPARTURE TO JONESTOWN AND HAD INQUIRED OF THE MILLS AS TO RYAN'S FLIGHT SCHEDULE. CARTER ALLEGED THAT HE WAS A DEFECTOR. [REDACTED] ADVISED THAT CARTER WAS BACK IN GUYANA UPON HER ARRIVAL. (U)

EX-MEMBERS HAVE ADVISED THAT THEY WERE PERSONALLY TOLD BY JONES THAT IN THE EVENT OF HIS ARREST PUBLIC OFFICIALS WERE TO BE KIDNAPPED. (U)

GRACE STOEN ADVISED THAT GUNS OVER WHICH SHE HAD INVENTORY CONTROL WERE SENT TO THE TEMPLE IN SAN FRANCISCO AND IT IS BELIEVED THEREAFTER SHIPPED VIA THE CUDJOE, A BOAT OWNED BY THE PT, TO JONESTOWN. (U)

ACCORDING TO [REDACTED] RYAN'S OFFICE RECEIVED A CURIOUS CALL ALLEGEDLY FROM PAN-AMERICAN AIRLINES A FEW DAYS PRIOR TO HIS DEPARTURE. A FEMALE SAID SHE WAS MAKING FINAL ARRANGEMENTS FOR THE FLIGHT INCLUDING VIP TREATMENT FOR RYAN AND WANTED TO FIRM UP THE SCHEDULE AND ITINERARY. WE DO NOT KNOW AT THIS TIME J4

b6
b7c

H

PAGE FIVE SF 89-250 UNCLAS E F T O

IF THIS CALL WAS AUTHENTIC OR NOT. (U)

ACCORDING TO DEBBIE BLAKEY, THERE WERE CONTINUAL DISCUSSIONS AT THE INSTIGATION OF JONES THAT IF ANYONE CAME TO JONESTOWN TO TAKE ANY OF THE CHILDREN OR OTHER PERSONS OUT OF JONESTOWN, THEY WOULD AMBUSHED AND KILLED. PLANNING DID TAKE PLACE FOR THESE AMBUSHES TO OCCUR ON THE ROAD OUT OF JONESTOWN. BLAKEY GAVE AN EXAMPLE THAT ON ONE OCCASION JONES LEARNED POSSIBLY THROUGH THE RADIO BROADCAST, THAT SOMEONE WAS FLYING INTO THE INTERIOR AND WOULD BE LANDING AT PORT KAITUMA AIRSTRIP AND THAT HE DID NOT KNOW WHO IT WAS AND WANTED TO FIND OUT. JONES SENT A NUMBER OF MEN ALONG WITH WEAPONS ON A FLATBED TRUCK TO THE AIRSTRIP TO DETERMINE THEIR IDENTITIES. TWO OTHER GROUPS WERE SENT OUT TO AWAIT THE PEOPLE WHERE THEY WERE TO AMBUSH THEM. OTHERS WERE INSTRUCTED TO CLIMB TREES WITH RIFLES AND TELESCOPIC SIGHTS TO ASSIST IN THE AMBUSH. (U)

LARRY LAYTON, PRETENDING TO BE A DEFECTOR, WENT WITH THE GROUP FROM JONESTOWN TO THE AIRSTRIP WHERE HE ENDED UP FIRING A WEAPON AT THE EXITING PARTIES. (U)

5

PAGE SIX SF 89-250 UNCLAS E F T O

A NEWSPAPER REPORTER HAS ADVISED THIS OFFICE THAT IN AN INTERVIEW WITH AN EX-MEMBER HE WAS TOLD THAT THE EX-MEMBER HAD BEEN IN CONTACT WITH JONES FIVE WEEKS PRIOR TO THE KILLING IN AN ATTEMPT TO DISSUADE JONES FROM CARRYING OUT THE PLAN TO KILL RYAN. THROUGH THE REPORTER, SPECIAL AGENTS HAVE LOCATED THIS EX-MEMBER WHO AT THIS TIME IS NOT ONLY DENYING HE SAID THAT BUT DENYING THAT HE IS AN EX-MEMBER. SAN FRANCISCO IS NOT PUTTING MUCH CREDENCE IN THIS INFORMATION AT THIS TIME BUT WILL CONTINUE TO PURSUE IT. (u)

NEWS ACCOUNTS INDICATED THAT A LETTER FROM ATTORNEY MARK LANE TO RYAN WARNING HIM OF DIRE CONSEQUENCES IF HE WENT TO GUYANA EXISTS. SAN FRANCISCO IS ATTEMPTING TO LOCATE THAT LETTER. (u)

UPON THE DEPARTURE OF CONCERNED PARENTS FROM SAN FRANCISCO AIRPORT ENROUTE TO GUYANA, TWO MEMBERS OF THE SAN FRANCISCO TEMPLE HAVE BEEN IDENTIFIED AS SURVEILLING THE GROUP.

THE ABOVE ITEMS ARE NOT IN ANY ORDER OF IMPORTANCE AND ARE A CONSENSUS OF INFORMATION FROM THE AGENTS AT SAN FRANCISCO COMMAND POST FROM SUMMARY TELETYPES RECEIVED FROM OTHER OFFICES (u)

6

PAGE SEVE SF 89-250 UNCLAS E F T O

AND INVESTIGATION CONDUCTED AT SAN FRANCISCO. ALL OF THESE
POINTS WILL BE FOLLOWED UP UPON THE RECEIPT OF DETAILED 302S. (u)

ARMED AND DANGEROUS; SUICIDAL TENDENCIES. (u)

BT

ME0001 3290230Z

PP HQ CO SF

DE ME

P 250230"ZNOV 78

FM MEMPHIS (89-110) (P)

TO DIRECTOR (89-4286) PRIORITY

COLUMBIA PRIORITY

SAN FRANCISCO (89-250) PRIORITY

BT

UNCLAS

RYMUR, OO: SAN FRANCISCO

RE MEMPHIS TELEPHONE CALLS TO FBIHQ AND SAN FRANCISCO

11/24/78 AND 11/25/78. (U)

ON THE EVENING OF 11/24/78 ATTORNEY MARK LANE CONTACTED THE MEMPHIS OFFICE AND INDICATED HE WAS CONCERNED THAT AN INDIVIDUAL BY THE NAME OF [REDACTED] HAD BEEN ALLEGEDLY RETAINED

BY THE PEOPLE'S TEMPLE TO BURGLARIZE HIS HOME AND THAT HE HAD BEEN INTERVIEWED BY TWO FBI AGENTS ON THE PRIOR DAY AND LANE

NEVER ADVISED. ACCORDING TO LANE THIS INFORMATION CAME FROM

A CBS CORRESPONDENT. INVESTIGATION AT MEMPHIS REVEALED THAT

[REDACTED]

A W/M BORN

[REDACTED]

IS CURRENTLY (U)

Relayed to 2288 & State 11/25/78

26 Nov 78 03 02 z
RECEIVED
FEDERAL BUREAU
OF INVESTIGATION
COMMUNICATIONS SECTION

Assoc. Dir.	
Dep. AD Adm.	
Dep. AD Inv.	
Asst. Dir.:	
Adm. Serv.	
Crim. Inv.	
Ident.	
Intell.	
Lab.	
Legal Coun.	
Plan. & Insp.	
Rec. Mgmt.	
Tech. Servs.	
Training	
Public Affs. Off.	
Telephone Rm.	
Director's Sec'y	

*10480 km/hdm 9/12/82 # 284125
24/92 # 284126
ALL INFORMATION CONTAINED
HEREIN IS UNCLASSIFIED
DATE 10/15/80 BY SP/ESK/PB
Comp. # 179, 431*

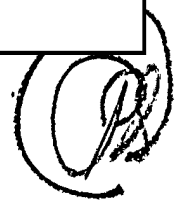

b6
b7c

58 NOV 29 1978

PAGE TWO ME 89-110 UNCLAS E F T O

INCARCINATED AT SHELBY COUNTY JAIL MEMPHIS, TENN. ON A BAD CHECK CHARGE. HE HAS BEEN IN JAIL SINCE 10/12/78. [REDACTED] DENIES ANY CONTACT OR KNOWLEDGE OF LANE HAVING PEOPLE'S TEMPLE OR REV. JIM JONES. [REDACTED] STATED THE FIRST KNOWLEDGE HE HAD WAS A CALL FROM HIS MOTHER ON THE EVENING OF 11/23/78 WHEREIN HIS MOTHER ADVISED HIM A CBS CORRESPONDENT HAD INDICATED [REDACTED] NAME WAS FOUND ALONG WITH SOME OF THE PERSONAL BELONGINGS OF REV. JONES IN GUYANA. (u)

[REDACTED] FURTHER INDICATED HE WAS CONTACTED BY A [REDACTED] WHO IDENTIFIED HIMSELF AS A CORRESPONDENT FOR ABC AND SPOKE TO HIM ON THE PHONE. [REDACTED] WAS TOLD BY THE JAIL PERSONNEL THAT A [REDACTED] ABC NEWS HAD CALLED AND ASKED IF THEY HAD A [REDACTED] AT THAT LOCATION. SINCE THAT TIME [REDACTED] FROM THE CBS AFFILIATE IN MEMPHIS HAS SPOKEN TO HIM AND INDICATED THAT HIS NAME WAS FOUND AMONG THE BELONGINGS OF REV. JONES ALONG WITH OTHERS. [REDACTED] IS UNABLE TO FURNISH ANY INFORMATION AS TO HIS NAME BEING INVOLVED BUT DOES RECALL APPROXIMATELY TWO WEEKS AGO A YOUNG FEMALE CALLED THE JAIL AND IDENTIFIED HERSELF AS BEING FROM THE DEPARTMENT OF (u)

b6
b7c

PAGE THREE ME 89-110 UNCLAS E F T O

HUMAN RESOURCES TO THE JAIL PERSONNEL. [REDACTED] SPOKE TO THIS FEMALE ON THE PHONE BUT ADVISED THAT SHE DID NOT IDENTIFY HERSELF AS BEING FROM THE DEPARTMENT OF HUMAN RESOURCES DURING HIS CONVERSATION BUT ASKED HIM IF HE KNEW A [REDACTED]? SHE ALSO ASKED HIM IF HE WOULD BE WILLING TO GO INTO AN ATTORNEY'S OFFICE HERE IN MEMPHIS AND WHETHER HE WOULD BE ABLE TO TAKE PHOTOGRAPHS. (U)

[REDACTED] TOLD HER THAT HE COULDN'T GO ANYWHERE WHILE HE WAS IN JAIL AND THAT HE WAS NOT GOING TO DISCUSS IT WITH HER UNTIL HE GOT OUT OF JAIL. [REDACTED] INDICATED HE HAS NO KNOWLEDGE IF THERE IS ANY CONNECTION BETWEEN THIS AND HIS NAME BEING INVOLVED IN THE PEOPLE'S TEMPLE BUT VEHEMENTLY DENIES ANY IMPLICATION WITH REV. JONES OR THE PEOPLE'S TEMPLE. (U)

[REDACTED] STATED HE DID KNOW A [REDACTED] BUT HAS NOT SEEN HIM FOR SEVERAL YEARS AND ONLY KNEW HIM AS A FELLOW INMATE.

ON 11/25/78 AN INTERVIEW WAS CONDUCTED AT THE RESIDENCE OF ATTORNEY MARK LANE BY ASAC RICHARD H. BLAY, SA [REDACTED] AND SECRET SERVICE AGENT [REDACTED] LANE INDICATED IMMEDIATELY THAT HE HAS A CLIENT WHO IS WILLING AND ANXIOUS TO TALK ABOUT THE MATTERS INVOLVING REV. JONES AND THE PEOPLE'S TEMPLE BUT THAT IMMUNITY MUST BE GRANTED PRIOR TO HER BEING MADE AVAILABLE FOR (U)

b6
b7c

VPAGE FOUR ME 89-110 UNCLAS E F T O

INTERVIEWED. LANE INDICATED HIS CLIENT HAD SOLE CUSTODY AND CONTROL OF SEVEN MILLION DOLLARS BELONGING TO THE PEOPLE'S TEMPLE.

LANE WAS ASKED IF HE KNEW THE LOCATION OF TERRY BUFORD BUT INDICATED HE COULD NOT OFFER A RESPONSE UNTIL THE IMMUNITY QUESTION HAD BEEN RESOLVED. IT WAS SUGGESTED TO LANE THAT ONE COULD CONCLUDE THAT THIS WAS HIS CLIENT AND HE ACKNOWLEDGED THAT THIS COULD BE A LOGICAL CONCLUSION. LANE INDICATED HE IS PRESENTLY WORKING ON A COMPLETE DIARY WHICH WILL HAVE ALL OF HIS KNOWLEDGE OF THE SITUATION IN GUYANA AND THE PEOPLE'S TEMPLE. HE STATED HE WOULD BE WILLING TO MAKE A COPY OF THIS AVAILABLE UPON ITS COMPLETION WHICH HE ANTICIPATED WOULD BE SOMETIME DURING THE EVENING OF SUNDAY 11/28/78. (u)

HE OFFERED AS SOON AS IT IS COMPLETED HE WOULD CONTACT ASAC BLAY AND MAKE IT AVAILABLE. LANE STATED HE HAD CALLED THE PEOPLE'S TEMPLE IN SAN FRANCISCO THE PREVIOUS EVENING TO ADVISE THEM THAT HE DID NOT WANT TO BE HARRASSED NOR DID HE WANT ANYONE BOTHERING HIS LOVED ONES. HE STATED HIS KNOWLEDGE OF THE ACTIONS BY REV. JONES AND THE PEOPLE'S TEMPLE WAS STAGE ONE OF A FOUR STAGE MASTER PLAN. HE STATED STAGE ONE WAS THE MASS MURDER OR (u)

PAGE FIVE ME 89-110 UNCLAS E F T O

SUICIDE OF THE PEOPLE WHICH HAS OCCURRED IN GUYANA. STAGE TWO WAS FOR ALL LEADERSHIP MEMBERS OF THE PEOPLE'S TEMPLE TO CONDEMN THESE ACTIONS. STAGE THREE WAS TO KILL ALL THE DEFECTORS FROM THE PEOPLE'S TEMPLE AND STAGE FOUR WAS TO KILL PUBLIC OFFICIALS. LANE DENIED KNOWLEDGE OF ANY SPECIFIC LIST OF PEOPLE WHO WOULD BE KILLED. (u)

LANE INDICATED THAT A REPORTER GORDON LINDSAY DID AN 88 PAGE REPORT ON REV. JONES AND THE PEOPLE'S TEMPLE. HE INDICATED THAT ^{THIS} ~~OPIS~~ IS A VERY ACCURATE PORTRAYAL OF THE SITUATION THAT EXISTED, HOWEVER, THE EDITOR OF THE NATIONAL INQUIRER HAD QUESTIONED OF ITS ACCURACY AND THEREFORE DID NOT PRINT IT. LANE SUGGESTED THAT THIS REPORT WOULD OFFER EXCELLENT BACKGROUND INFORMATION ON THE OPERATION OF THE COMMUNE AT JONESTOWN. LANE ALSO INDICATED THAT REV. JONES HAD THREE MILLION DOLLARS IN HIS CABIN AND IN NEWSPAPER ACCOUNTS HE HAS RETD ONLY A HALF MILLION HAS BEEN FOUND. LANE ALSO MENTIONED TWO SHIPS BELONGING TO THE PEOPLE'S TEMPLE THAT HAD CONSIDERABLE CASH ABOARD THEM. (u)

LANE STATED THAT HE HAS NOT READ ANY INFORMATION WHERE THE

(u)

PAGE SIX ME 89-110 UNCLAS E F T O

SECOND SHIP HAS BEEN LOCATED. LANE ALSO INDICATED THAT HE FELT THAT ATTORNEY CHARLES GARRY WAS AWARE THAT JONES WAS DANGEROUS AS HE INDICATED THAT A RADIO TRANSMISSION HAD BEEN MONITORED BETWEEN JONES AND GARRY. STATED THAT THIS CONVERSATION ON 10/6/77 JONES INDICATED HE WAS GOING TO KILL EVERYONE IN JONESTOWN. LANE REITERATED THAT HE HAD HEARD THERE WAS A HIT LIST FOR PEOPLE TO BE ASSASSINATED BUT IS NOT AWARE OF THE IDENTITIES OF ANY PEOPLE ON THE HIT LIST. LANE INDICATED THAT HE WOULD ANSWER ANY QUESTIONS REGARDING THIS MATTER AND SUGGESTED THAT ONCE THE DIARY WAS READ THAT HE WOULD BE WILLING TO ANSWER ANY QUESTION OPPOSED. LANE ALSO SUGGESTED THAT MEMBERS OF THE PEOPLE TEMPLE IN SAN FRANCISCO WOULD BE ABLE TO OFFER INVALUABLE INFORMATION TO ASSIST IN THIS INVESTIGATION. (u)

CONTACT WILL MAINTAINED WITH LANE TO OBTAIN A COPY OF THE DIARY.

FBIHQ WILL BE KEPT ADVISED OF ALL IMPERTINENT DEVELOPMENTS. (u)

BT

NNNNVV FBA111

OO RUEHFB

DE RUEHC #9151 3301912

ZNY CCCCC ZZH

O 26185Z NOV 78

FM SECSTATE WASHDC

TO RUESON/AMEMBASSY GEORGETOWN IMMEDIATE 3891

RUEKJCS/ SECDEF WASHDC IMMEDIATE 2128

RUEKJCS/ JCS WASHDC IMMEDIATE 1727

RUEHFB/FBI WASHDC IMMEDIATE

RUEHJSA/HEW WASHDC IMMEDIATE

EF

~~CONFIDENTIAL~~

LIMITED OFFICIAL USE STATE 299151

E.O. 11652: N/A

REC-102

TAGS: CASC, OREP (RYAN, LEO) GY

SUBJECT: RELEASE OF JONESTOWN SURVIVORS AND RETURN TO THE UNITED STATES

1. MEDIA REPRESENTATIVES ARE BEGINNING TO CONVERGE ON CHARLESTON, SOUTH CAROLINA AS INTEREST IN ARRIVAL OF JONESTOWN SURVIVORS MOUNTS, DESPITE STATE PRESS SPOKESPERSONS INDICATING NO SURVIVOR FLIGHT WILL ARRIVE PRIOR TUESDAY AT EARLIEST.

58 NOV 29 1978

26 NOV 78 19 28z

FEDERAL BUREAU OF INVESTIGATION COMMUNICATIONS SECTION

Assoc. Dir.	
Dep. AD Adm.	
Dep. AD Inv.	
Asst. Dir.:	
Adm. Serv.	
Crim. Inv.	
Ident.	
Int'l.	
Laboratory	
Legal Coun.	
Plan. & Insp.	
Rec. Mgmt.	
Tech. Servs.	
Training	
Public Affs. Off.	
Telephone Rm.	
Director's Sec'y	

FBI
ALL INFORMATION CONTAINED
HEREIN IS UNCLASSIFIED
DATE 9/24/92 BY 1048 DKN/AMH

FEDERAL GOVERNMENT

89-4286-391

Relayed
Ba, (6) 87 UESP
11-26-78
L761ajp

2. BASED ON BEST INFORMATION FROM AMEMBASSY GEORGETOWN,
JONESTOWN SURVIVORS WILL NOT RPT NOT ARRIVE CHARLESTON
PRIOR RPT PRIOR TO TUESDAY, NOV. 28. EVEN TUESDAY
ARRIVAL IS INDETERMINABLE SINCE GOVERNMENT OF GUYANA (GOG)
AUTHORITIES HAVE NOT YET INFORMED USG WHEN SURVIVORS WILL
BE RELEASED, AND ARRIVAL MIGHT SLIP SEVERAL DAYS.
MOREOVER IT MAY BE THE SIZE OF GROUP WILL BE MUCH REDUCED
AND MAY NOT EVEN JUSTIFY SPECIAL MILITARY FLIGHTS.

3. EMBASSY HAS BEEN INSTRUCTED TO NOTIFY DEPARTMENT
AS SOON AS THEY RECEIVE RELEASE INFORMATION WHICH WE

WILL FORWARD TO ALL ADDRESSEES ASAP. UNDER NO CIR-
CUMSTANCE WOULD SURVIVORS ARRIVE IN CHARLESTON LESS
THAN 24 HOURS FROM THIS NOTIFICATION.

3. REQUEST JCS ADVISE APPROPRIATE COMMANDS OF ABOVE
INFORMATION.

CHRISTOPHER

BT

#9151

BA0001 3300900Z

OO HI SF LA CO

DE BA

O 260825Z NOV 78

FM BALTIMORE (89-173)

TO DIRECTOR IMMEDIATE

SAN FRANCISCO IMMEDIATE

LOS ANGELES IMMEDIATE

COLUMBIA IMMEDIATE

26 Nov 78 09 09z

FEDERAL BUREAU OF INVESTIGATION COMMUNICATIONS SECTION

Assoc. Dir.	_____
Dep. AD Adm.	_____
Dep. AD Inv.	_____
Asst. Dir.:	_____
Adm. Serv.	_____
Crim. Inv.	_____
Ident.	_____
Intell.	_____
Laboratory	_____
Legal Coun.	_____
Plan. & Insp.	_____
Rec. Mgmt.	_____
Tech. Servs.	_____
Training	_____
Public Affs. Off.	_____
Telephone Rm.	_____
Director's Sec'y	_____

ALL INFORMATION CONTAINED HEREIN IS UNCLASSIFIED DATE 9/21/92 BY 1046 DCM/MLM

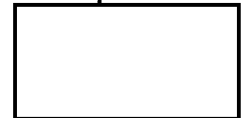

b6 b7C

BT

UNCLAS EFTO

RYMUR

FOR INFO HEADQUARTERS AND SAN FRANCISCO, HOWARD AND BEVERLY OLIVER ARRIVED ANDREWS AIR FORCE BASE (AFB) ON NOVEMBER 25, 1978 IN MID EVENING AND WILL DEPART (AFB) EARLY MORNING OF NOVEMBER 26, 1978 AND ARRIVE TRAVERS AIR FORCE BASE, CALIFORNIA 6:25 PM ON NOVEMBER 26, 1978 VIA USAF MEDIVAC FLIGHT 1614 (W)

MRS. OLIVER CONTACTED AND ADVISED SHE HAD BEEN INTERVIEWED IN DETAIL BY AGENTS IN FAJARAO, PUERTO RICO. MRS. OLIVER ADVISES HER HUSBAND STILL RECOVERING FROM STROKE AND UNABLE TO BE INTERVIEWED CONSEQUENTLY, NO INTERVIEW CONDUCTED WITH HUSBAND. MRS. OLIVER ADVISED ALL INFO SHE HAD WAS PREVIOUSLY FURNISHED AT FAJARAO, PUERTO RICO. (W)

REC-102 89-4286-392

BT



58 NOV 21 9 1978

SEC002 0328Z

OO HQ SF

DE SE

O 250320Z NOV 78

Assoc. Dir.	_____
Dep. AD Adm.	_____
Dep. AD Inv.	_____
Asst. Dir.:	_____
Adm. Serv.	_____
Crim. Inv.	_____
Ident.	_____
Intell.	_____
Laboratory	_____
Legal Coun.	_____
Plan. & Insp.	_____
Rec. Mgnt.	_____
Tech. Servs.	_____
Training	_____
Public Affs. Off.	_____
Telephone Rm.	_____
Director's Sec'y	_____

26 Nov 78 0347
 RECEIVED
 FEDERAL BUREAU
 OF INVESTIGATION
 COMMUNICATIONS SECTION

FM SEATTLE (89-158) (P)

TO DIRECTOR (89-4286) (IMMEDIATE)

FROM SAN FRANCISCO (89-250) (IMMEDIATE)

BT

ALL INFORMATION CONTAINED
 HEREIN IS UNCLASSIFIED
 DATE 9/24/92 BY 6016 DVA/MLM

UNCLAS

RYMUR. OO: SAN FRANCISCO

RE SF TEL 11/24/78 TO SEATTLE.

White Male
 DOB
 IN SSAN

SPOKANE, WA.

[REDACTED] ADVISED HE HAD JOINED PEOPLES TEMPLE (PT) IN 1969

AND WAS MEMBER UNTIL 1973. [REDACTED] PT PLANNING

COMMISSION WHICH INCLUDED THE FOLLOWING PEOPLE: (U)

JIM JONES, GRACE STONE, TIM STONE, LEE INGRAHAM (PH)
 LINDA AMOS, DON BECK, BONNIE BECK, SANDY BRADSHAW, CAROLYN
 LEIGHTON, LARRY LEIGHTON, KAREN LEIGHTON, AND GRACE STONE
 AN ATTORNEY. (U)

DE-5 REC-102

89-4286-393

THIS GROUP HAD A PACT THAT IF ANYONE LEFT THEY WOULD BE
 HUNTED DOWN AND HAVE THEIR THROAT CUT. IT IS UNKNOWN IF THIS
 WAS EVER DONE. (U)

23 NOV 23 1978

58 NOV 29 1978

b6
b7C

PAGE TWO SE 89-158 UNCLAS

[REDACTED] LEFT THE CHURCH IN 1973 WITH ~~JIM LOBB~~, MICKEY TOUCHETTE, WAYNE RIETELA, ALL OF SAN FRANCISCO, AND TOM POSBORSKI OF INDIANAPOLIS, INDIANA. (u)

[REDACTED] IS PERSONALLY AWARE OF ONLY ONE CRIME AND THIS OCCURED DURING LATE SUMMER 1972 WHEN [REDACTED] APPROACHED [REDACTED] ABOUT KILLING LESTER KINSOLVING. JONES LATER ALLEDED TO THIS BUT NEVER ACTUALLY REQUESTED [REDACTED] CARRY OUT THE ACT. [REDACTED] WILL TESTIFY TO THIS IF REQUIRED. (u) Cu

[REDACTED] BELIEVES MORE ASSASSINATIONS WILL BE CARRIED OUT ACCORDING TO JONES'S WISHES SPECIFICALLY BY SANDY BRADSHAW, LINDA AMOS, CAROLYN AND KAREN LEIGHTON. IT IS BELIEVED THESE WOMEN HAVE ALL AVAILABLE INSIDE INFORMATION TO JONES'S OPPERATION AND WERE DEVOUT FOLLOWERS AS WELL AS HIS MISTRESSES. (u) Cu

[REDACTED] ADVISED ~~JIM SUNBAR~~ CAUSED JONES MUCH GRIEF AND JONES WANTED HIM NEUTRALIZED BUT NEVER ORDERED HIS DEATH. JONES ALLEGEDELY ORDERED THE DEATH OF WHITEY AND OPAL FREESTONE, UKIHA CALIFORNIA BUT IT IS NOT BELIEVED THIS OCCURED. JONES IS BELIEVED TO HAVE DEFRAUDED ON INCOME TAX BY HAVING HIS SEC.-TREASURER, ~~EVA RUGH~~, BURY LARGE SUMS OF MONEY. [REDACTED] HAS HEARD TALK OF THE CHURCH HAVING 15 TO 20 MILLION DOLLARS. (u) Cu

b6
b7C

PAGE THREE SE 89-158 UNCLAS

IT IS ALSO BELIEVED LINDA SWAINNEY (PH) AN EXECUTIVE WITH MASON-
ITE CORPERATION, UKIHA, MAY HAVE INFORMATION AS SHE TOOK
NUMEROUS PAPERS AND DOCUMENTS WHEN SHE LEFT THE CHURCH.

[REDACTED] KNOWS OF NO OTHER FEDERAL OR LOCAL VIOLATIONS COMMITTED
BY THE GROUP. (u)

b6
b7C

[REDACTED] IS DESCRIBED AS FOLLOWS: WHITE MALE,

DOR [REDACTED] BROWN HAIR, BLUE EYES, [REDACTED]

[REDACTED] SSAN. [REDACTED]

[REDACTED] FD-302 TO FOLLOW (u)

SINCE SEATTLE IS UNAWARE OF INVESTIGATION ALLREADY CONDUCTED
BY SAN FRANCISCO DIVISION LEADS AT UKIHA ARE BEING LEFT TO THE OO.
BT (u)

DEPARTMENT OF JUSTICE
FEDERAL BUREAU OF INVESTIGATION
COMMUNICATION MESSAGE FORM

005

PAGE

DATE 11/20/78	CLASSIFICATION UNCLAS E F T O	PRECEDENCE IMMEDIATE
------------------	----------------------------------	-------------------------

FM005000 IP SC SEIDE HQ H0005 325#DTHYETO 210141Z NOV 78

FM EM DIRECTOR FBI
 TO TO FBI MIAMI IMMEDIATE
 FBI SAN FRANCISCO IMMEDIATE
 14 FBI SACRAMENTO IMMEDIATE
 FBI INDIANAPOLIS IMMEDIATE

ALL INFORMATION CONTAINED
HEREIN IS UNCLASSIFIED
DATE 9/24/02 BY 1046 DSA/under

12 BT

UNCLAS E F T O

10 RYMUR.

DO NOT TYPE PAST THIS LINE

FBIHQ IS IN RECEIPT OF UNCONFIRMED INFORMATION THAT JIM
 8 JONES, LEADER OF THE PEOPLES TEMPLE OF CHRISTIAN DISCIPLES OF
 GOD, HAS BEEN FOUND AMONG THE DEAD IN JONESTOWN, GUYANA.
 6 THE IDENTIFICATION IS TENTATIVE IN THAT PERSONS DESIRING TO
 LEAVE THE JONESTOWN, GUYANA, COMPOUND STATED THAT BODY
 4 WHICH HAS WOUNDS IN THE HEAD IS THAT OF JIM JONES. ALSO
 TENTATIVELY IDENTIFIED IS JONES' WIFE (u)

2 TO EFFECT MORE POSITIVE IDENTIFICATION SACRAMENTO IS
 REQUESTED TO OBTAIN IDENTIFYING DATA FROM CALIFORNIA STATE (u)

DO NOT TYPE MESSAGE BELOW THIS LINE

APPROVED BY DWM LFS	DRAFTED BY LFS:BVM	DATE 11/20/78	ROOM 5027	TELE EXT. 2805
------------------------	-----------------------	------------------	--------------	-------------------

- 1 - MR. ADAMS
- 1 - MR. MOORE
- 1 - MR. INGRAM
- 1 - MR. GOW
- 1 - MR. []
- 1 - MR. []

REC-102
FEDERAL BUREAU OF INVESTIGATION
COMMUNICATIONS SECTION

89-4286-394

11 NOV 21 1978

b6
b7c

NOV 21 1978
03102 CG
TELETYPE

58 NOV 30 1978

DEPARTMENT OF JUSTICE
FEDERAL BUREAU OF INVESTIGATION
COMMUNICATION MESSAGE FORM

PAGE 2

CONTINUATION SHEET

PAGE TWO REDE HQ 0005 UNCLAS E F T O

ATTORNEY GENERAL'S OFFICE REGARDING JONES INCLUDING, IF
 20 POSSIBLE, FINGERPRINT CLASSIFICATION (u)
 18 JONES FURTHER DESCRIBED AS JAMES WARREN JONES, TRUE NAME,
 WHITE MALE; DOB MAY 13, 1931, OR MAY 13, 1933; 5'10"; 188 LBS.;
 16 BROWN HAIR AND EYES; LAPD NUMBER 1286450/J27C7007; CALIFORNIA
 LICENSE R423673; LAST KNOWN RESIDENCE 1857 GEARY,
 14 SAN FRANCISCO; GRADUATE BUTLER UNIVERSITY, INDIANA, WHERE
 HE OBTAINED PH.D. (u)
 12 INDIANAPOLIS AT BUTLER UNIVERSITY REVIEW UNIVERSITY FILES
 REGARDING IDENTIFYING DATA ON SUBJECT (u)
 10 ARMED AND DANGEROUS: (u)

BT

DO NOT TYPE PAST THIS LINE

DO NOT TYPE MESSAGE BELOW THIS LINE

2

SFO 796 3290107Z

Assoc. Dir.	
Dep. AD Adm.	
Dep. AD Inv.	
Asst. Dir.:	
Adm. Serv.	<input checked="" type="checkbox"/>
Crim. Inv.	<input checked="" type="checkbox"/>
Ident.	
Intell.	
Laboratory	
Legal Coun.	
Plan. & Insp.	
Rec. Mgmt.	
Tech. Servs.	
Training	
Public Affs. Off.	
Telephone Rm.	
Director's Sec'y	

OO HQ

26 Nov 78 0119Z

DE SF 005

0 260102Z NOV 7

FEDERAL BUREAU OF INVESTIGATION COMMUNICATIONS SECTION

FM SAN FRANCISCO (8-250) (P) (SQUAD 10)

TO DIRECTOR, FBI (8-4286) IMMEDIATE

ATTN: CID COMMAND POST

BT

ALL INFORMATION CONTAINED HEREIN IS UNCLASSIFIED DATE 9/24/92 BY 1048 DIC/wh

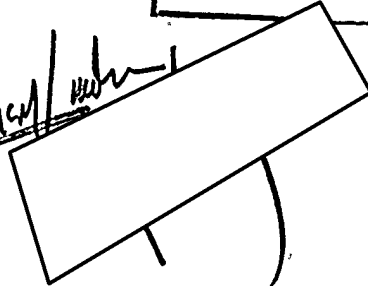

UNCLAS E F T O

RYMUR

SAN FRANCISCO DAILY SUMMARY (U)

b6
b7C

RESEARCH DONE THIS DATE REGARDING ANY POINTS WHICH TEND TO INDICATE CONSPIRACY FOR DUAL PURPOSE OF INVESTIGATIVE DIRECTION AND RESOLVING VENUE DISPUTE. (U)

LAST PORTION OF CII FINGERPRINT CARDS BEING SENT UNITED AIR LINES AIR EXPRESS. (U)

EX-MEMBER INTERVIEWS CONTINUING. (U)

INFORMATION RECEIVED THIS DATE REGARDING 2,000 TO 3,000 LETTERS SENT BY MEMBERS TO IRS WHICH CONTAIN MEMBERS' RETURN ADDRESSES. FBIHQ REQUESTED TO OBTAIN SAME (U)

REC-102 89-4286-395

BUREAU FURNISHED BY AIRTEL THIS DATE, ATTENTION CID COMMAND POST, NEGATIVES OF PHOTOS OF AFFIDAVIT SIGNED BY SOME 800-900 RESIDENTS OF JONESTOWN. (U)

NOV 28 1978

ARMED AND DANGEROUS; SUICIDAL TENDENCIES. (U)

BT

58 NOV 30 1978

WV FBA070

OO RUEHFB

DE RUEHC #9116 3300143

ZNY CCCCC ZZH

O R 260118Z NOV 78

FM SECSTATE WASHDC

TO RUESON/AMEMBASSY GEORGETOWN IMMEDIATE 3887

INFO RUCIMAA/CINCMAC SCOTT AFB ILL

RUCJAAA/USREDCOM/RCJ2 MACDILL AFB FLA

RUCLHTD/USCINCARRED FT MCPHERSON GA

RUCLGFA/CD 18TH AIRBORNE CORPS FTBRAGG NC

RUEHFB/FBI

FEDERAL GOVERNMENT

RUEAUSA/HEW

RUEKJCS/ SECDEF WASHDC 2124

RUEKJCS/ JCS WASHDC 1722

RULPALJ/CINCSOUTHCOM QUARRY HTS CANAL ZONE

BT

REC-102

~~CONFIDENTIAL~~ STATE 299116

E.O. 11652: GDS

TAGS: CASC, OREP (RYAN, LEO), GY

SUBJECT: ARRANGEMENTS FOR RETURN OF SURVIVORS

58 DEC 11 1978

REF: BUSHNELL/DIKEOS TELECON

Declass per State let 2/16/05
UC65179DMD/ST/bpg

26 Nov 78 01 59 Z

LABORATORY SECTION

Assoc. Dir.	
Dep. AD Adm.	
Dep. AD Inv.	
Asst. Dir.:	
Adm. Serv.	<input checked="" type="checkbox"/>
Crim. Inv.	<input checked="" type="checkbox"/>
Ident.	
Insp.	
Laboratory	
Legal Coun.	
Plan. & Insp.	
Rec. Mgmt.	
Tech. Servs.	
Training	
Public Affs. Off.	
Telephone Rm.	
Director's Sec'y	

ALL INFORMATION CONTAINED
HEREIN IS UNCLASSIFIED
DATE 9/24/02 BY 1011 P/ML/ML

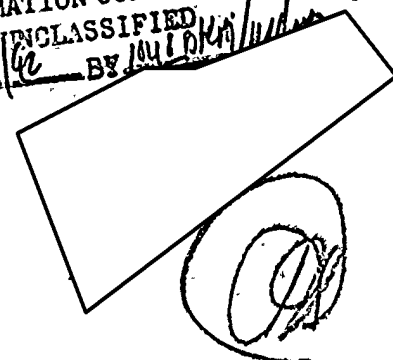

b6 per FBI
b7c

89-4286 - 396

23 NOV 28 1978

RDS

1. PRESS ALREADY BEGINNING TO CONVERGE ON CHARLESTON, SOUTH CAROLINA, AS INTEREST IN POTENTIAL ARRIVAL OF SURVIVORS AT CHARLESTON AIR FORCE BASE (AFB) MOUNTS. WE EXPECT GREAT PRESSURE FROM LARGE NUMBERS OF PRINT, RADIO, AND TV JOURNALISTS FOR ACCESS TO SURVIVORS FOR INTERVIEWS AND FILMING.

2. WE ARE NOW IN PROCESS OF DEVELOPING ARRANGEMENTS TO RECEIVE AND PROCESS SURVIVORS. WHILE WE SEE NO PROBLEM IN PROVIDING PRESS OPPORTUNITY TO PHOTOGRAPH ARRIVAL OF PLANE FROM A DISTANCE, WE ARE LOOKING AT QUESTION OF MEDIA ACCESS DURING PROCESSING AND DEPARTURE FROM BASE IN VIEW OF THE REPORTED CONCERN OF SOME SURVIVORS FOR THEIR PERSONAL SAFETY.

3. IN DEVELOPING OUR PLANS IT WOULD BE HELPFUL TO HAVE EMBASSY'S RECOMMENDATIONS AND ADVICE. IT WOULD BE OF GREAT ASSISTANCE IF WE KNEW ATTITUDE OF SURVIVORS (OR A SAMPLING OF OPINION) ON THIS ISSUE. IT MAY BE THAT SOME SURVIVORS

WOULD WELCOME AN OPPORTUNITY TO TELL THEIR STORIES TO THE MEDIA WHILE OTHERS WOULD PREFER ANONYMITY INSOFAR AS POSSIBLE. CHRISTOPHER

BT

#9116

Assoc. Dir.	_____
Dep. AD Adm.	_____
Dep. AD Inv.	_____
Asst. Dir.:	<u>M-28</u>
Adm. Serv.	_____
Crim. Inv.	_____
Ident.	_____
Insp.	_____
Laboratory	_____
Legal Coun.	_____
Plan. & Insp.	_____
Rec. Mgmt.	_____
Tech. Servs.	_____
Training	_____
Public Affs. Off.	_____
Tolson Rm.	_____
Director's Sec'y	_____

PAGE 01 STATE 299118
ORIGIN ARA-15 26 NOV 78 0241Z

FEDERAL BUREAU OF INVESTIGATION
COMMUNICATIONS SECTION

INFO OCT-01 SCS-06 CA-01 ISO-00 FBIE-00 JUSE-00 L-03

H-01 CIAE-00 INR-10 NSAE-00 SS-15 NSCE-00 SSC b6 per FBI
INRE-00 /052 R b7C

[Handwritten signature]

[Handwritten initials]

[Redacted box with handwritten initials]

DRAFTED BY ARA:JBUSHNELL:MJB

APPROVED BY ARA:JBUSHNELL

MILREP:COMDR. SMORRISON

FEDERAL GOVERNMENT

SCS:RDAVIS

FBI
ALL INFORMATION CONTAINED
HEREIN IS UNCLASSIFIED
DATE 9/29/92 BY 1048 DCM/ndm

S/S-O:RCASTRODALE

AAAAAAAAAAAAAAAAAAAAA P I T E W P 260223Z /73

O 260203Z NOV 78

FM SECSTATE WASHDC

TO JCS WASHDC IMMEDIATE 1723

INFO AMEMBASSY GEORGETOWN IMMEDIATE

USCINCPAC MACDILL AFB FLA

REC-102

USCINCSO QUARRY HEIGHTS CZ

CINCPAC SCOTT AFB ILL

CSA WASHINGTON DC

CSAF WASHDC

89-4286-397

[Large handwritten mark]

~~CONFIDENTIAL~~

STATE 299001
Declass per State let 2/16/05
UC65179DMH/ST/bpg

58 NOV 30 1978

E.O. 11652: GDS

TAGS: CASC, OREF (RYAN, LEO), GY

SUBJECT: US MILITARY SUPPORT TO GUYANA INCIDENT

REF: JCS 252334Z NOV 78 (NOTAL)

1. STATE DEPARTMENT CONCURS WITH INITIATION REDEPLOYMENT FROM GUYANA. HOWEVER, FOLLOWING REQUIREMENTS AND POTENTIAL REQUIREMENTS SHOULD BE KEPT IN MIND IN PLANNING FIRST STAGES REDEPLOYMENT.

~~CONFIDENTIAL~~

2

~~CONFIDENTIAL~~

PAGE 02

STATE 299118

2M WE BELIEVE IT IS IMPERATIVE THAT FINAL SEARCH JONESTOWN SETTLEMENT AND SURROUNDING CLEARED AREAS BE MADE BY AMERICAN MILITARY PERSONNEL ACCOMPANIED BY EMBASSY PERSONNEL TO ASSURE THAT ALL BODIES HAVE BEEN RECOVERED. THIS SEARCH SHOULD BE MADE IN DAYLIGHT.

3. EMBASSY HAS RESPONSIBILITIES FOR INVENTORY OF PROPERTY IN JONESTOWN AND ASSISTANCE IN SECURING MOVABLE ASSETS. DOD TRANSPORT AND OTHER ASSISTANCE WILL BE REQUIRED.

4. GOG HAS REQUESTED TRANSPORT ASSISTANCE IN ITS ROLE OF SUPPLYING PHYSICAL SECURITY TO JONESTOWN AND IS CONTINUING INVESTIGATION DURING NEXT FEW WEEKS. THIS REQUEST NOW BEING ADDRESSED BY VARIOUS USG AGENCIES AND WE ANTICIPATE

DECISION WITHIN 40 HOURS. U.S. INVESTIGATIVE PERSONNEL MAY ALSO REQUIRE AIR TRANSPORT.

5. REQUIREMENT MAY EXIST FOR EVACUATION SURVIVORS, INCLUDING THOSE NOW HOSPITALIZED.

6. THERE MAY BE OTHER REQUIREMENTS WHICH EMBASSY MAY IDENTIFY.

13

7. NEVERTHELESS, IT WOULD APPEAR THAT SOME DOD ASSETS
NOW IN GUYANA ARE NO LONGER NEEDED AND SUCH ASSETS MAY
BE REDEPLOYED PENDING COMPLETE ANALYSIS ADDITIONAL RE-
QUIREMENTS. IN PARTICULAR REDEPLOYMENT GRAVES REGISTRA-
TION UNIT, SOME PERSONNEL AND SOME HELICOPTERS SHOULD
PROCEED IN COORDINATION WITH AMB/ BURKE. CHRISTOPHER

~~CONFIDENTIAL~~

4

CONFIDENTIAL

FBB643

26 Nov 78 07 58z

PAGE 01

260730Z

ACTION ARA-15

FEDERAL BUREAU OF INVESTIGATION COMMUNICATIONS SECTION

ALL INFORMATION CONTAINED HEREIN IS UNCLASSIFIED DATE 9/24/92 BY 1048 DKN/ML

Assoc. Dir.	
Dep. AD Adm.	
Dep. AD Inv.	3
Asst. Dir.:	11
Adm. Serv.	11
Crim. Inv.	11
Ident.	
Int'l.	
Laboratory	
Legal Coun.	
Plan. & Insp.	
Rec. Mgnt.	
Tech. Servs.	
Training	
Public Affs. Off.	
Telephone Rm.	
Director's Sec'y	

Sw

INFO OCT-01 SCS-06 INR-10 INRE-00 SS-15 SSO-00 SY-05
 SYE-00 H-01 FBIE-00 CIAE-00 CA-01 USSS-00 AID-05
 NSCE-00 CCO-00 OC-06 JUSE-00 NSAE-00 ICAE-00 PA-00
 TRSE-00 CG-00 L-03 DOTE-00 /069 W

b6 per FBI
b7c

-----AAAAAPIUOTQ 260740Z /23

O 260726Z NOV 78
 FM JCS WASHINGTON DC//J3//
 TO SECSTATE WASHINGTON DC

GOVERNMENT

Leo J Ryan

~~CONFIDENTIAL~~ 4465

SUBJ: FINAL SEARCH OF JONESTOWN SETTLEMENT AREA (U)

REFS: A. SECSTATE 260203Z NOV 78

B. TELECON COL GARRISON, USMC, JCS/CAT TEAM CHIEF AND

COL GORDON, USA, COMUSJTF BY OF 260300Z NOV 78

REC-102 85-4286-398

(U) 1. ~~001~~ BY SECSTATE 260203Z NOV 78, A FINAL, DAYLIGHT SEARCH FOR BODIES IN JONESTOWN SETTLEMENT AND SURROUNDING CLEARED ARE AS WAS REQUESTED. 23 NOV 29 1978

(U) 2. ~~001~~ BY REF B IT WAS REPORTED THAT A THOROUGH SEARCH OF SUBJECT AREA WAS CONDUCTED DURING DAYLIGHT HOURS WITH NEGATIVE RESULTS.

AMBASSADOR BURKE WAS SO NOTIFIED.

QDS 84

508 NOV 30 1978

Declassified per DOD let 7/21/2005 65179DMH/ST/bpg

~~CONFIDENTIAL~~

FBB 634

Assoc. Dir.	_____
Dep. AD Adm.	_____
Dep. AD Inv.	_____
Asst. Dir.:	_____
Adm. Serv.	_____
Crim. Inv.	_____
Ident.	_____
Intell.	_____
Laboratory	_____
Legal Coun.	_____
Plan. & Insp.	_____
Rec. Mgnt.	_____
Tech. Servs.	_____
Training	_____
Public Affs. Off.	_____
Telephone Rm.	_____
Director's Sec'y	_____

PAGE P2 STATE 2991336 Nov 78 0437
ORIGIN L-03

RECEIVED
FEDERAL BUREAU
OF INVESTIGATION
COMMUNICATIONS SECTION

INFO OCT-01 ARA-11 ISO-00 SCS-06 CA-01 SSO-00 H-0
SS-15 JUSE-00 FBIE-00 /033 R

DRAFTED BY L/ARA:MKOZAK:MJB
APPROVED BY ARA-RERUCE
S/S-O:RCASTRODALE

FBI
ALL INFORMATION CONTAINED
HEREIN IS UNCLASSIFIED
DATE 9/21/92 BY 1048 DCM/mdu



b6 per F
b7C

-----AAAAAAAAAAPIYTIP 260432Z /12

O 260355Z NOV 78 ZFF4

FM SECSTATE WASHDC

FEDERAL GOVERNMENT

TO AMEMBASSY GEORGETOWN NIACT IMMEDIATE

~~CONFIDENTIAL~~ STATE 299133 Declass per State let 2/16/05
UC65179DMH/ST/bpg

E.O. 11652: GDS

REC-102

89-4286-399

TAGS: CASC, OREP (RYAN, LEO), GY, AFSP

SUBJECT: ENGAGEMENT OF LOCAL LEGAL COUNSEL TO ASSIST USE

TO DISCHARGE RESPONSIBILITIES IN CONNECTION WITH JONESTOWN

DISASTER AND ESTATES OF DECEASED AMERICANS

NOV 29 1978

58 NOV 30 1978

RE: GEORGETOWN 3933 AND PREVIOUS

1. BEFORE PROCEEDING TO RETAIN [REDACTED], WE WOULD WANT TO CONSIDER FURTHER THE IMPLICATIONS OF HIS FIRM'S INVOLVEMENT IN THE STOEN CASE AND POTENTIAL INVOLVEMENT IN THE LAYTON DEFENSE.

b6 per FBI
b7C

2. MEANWHILE, WOULD APPRECIATE YOUR ADVISING US WHETHER [REDACTED] REPRESENTS THE ONLY FEASIBLE OPTION. IS HE THE ONLY PERSON WHO, IN YOUR JUDGMENT, IS PROPERLY QUALIFIED TO PROVIDE ADVICE TO THE USG?

3. APPRECIATE YOUR JUDGMENT SOONEST SO THAT WE CAN MAKE EARLY DECISION ON THIS MATTER. CHRISTOPHER

~~CONFIDENTIAL~~

NNNNVV FBA075

OO RUEHFB

DE RUEHC #9132 3300425

ZNY CCCCC ZZH

O R 260354Z NOV 78 ZFF4

FM SECSTATE WASHDC

TO RUESON/AMEMBASSY GEORGETOWN NIACT IMMEDIATE 3890

INFO RUCIMAA/CINCMAC SCOTT AFB ILL

RUCIMAA/USREDCOM/RCJ2 MACDILL AFB FLA

RUCBHTD/USCINCARRED FT MCPHERSON GA

RUCGFA/CG 18TH AIRBORNE CORPS FT BRAGG NC

RUCPALJ/CINCSOUTHCOM QUARRY HTS CANAL ZONE

RUEHFB/FBI

RUEAUSA/HEW

RUEKJCS/ SECDEF WASHDC 2126

RUEKJCS/ JCS WASHDC 1725

BT

~~CONFIDENTIAL~~ STATE 299132

REC-102

E.O. 11652: GDS

TAGS: CASC, OREP (RYAN, LEO), GY

SUBJECT: ARRANGEMENTS FOR RETURN OF SURVIVORS

58 NOV 30 1978

REF: STATE 299116 AND DIKEOS/BUSHNELL TELECON

26 Nov 78 04 34
RECEIVED
FEDERAL BUREAU
OF INVESTIGATION
COMMUNICATIONS SECTION

Assoc. Dir.	
Dep. AD Adm.	
Dep. AD Inv.	
Asst. Dir.:	
Adm.	
Crim. Inv.	
Ident.	
Intell.	
Laboratory	
Legal Coun.	
Plan. Insp.	
Rec. Mgmt.	
Tech. Serv.	
Training	
Public Affs. Off.	
Telephone Rm.	
Director's Sec'y	

ALL INFORMATION CONTAINED
HEREIN IS UNCLASSIFIED
DATE 9/29/92 BY 1096 DKM/whk

b6 per FBI
b7C

FEDERAL GOVERNMENT

Declass per State let 2/16/05
UC65179DMH/ST/bpg

89-4286-400

23 NOV 28 1978

1. SINCE TELECON AND REFTEL WE HAVE DISCUSSED PREPARATIONS BEING MADE AT CHARLESTON TO RECEIVE SURVIVORS WITH HEW REPRESENTATIVE AL BATTISTE. HE REPORTS THAT HE HAS MADE THE FOLLOWING ARRANGEMENTS FOR SECURITY, TRANSPORTATION AND LODGING OF THE JONESTOWN SURVIVORS AT CHARLESTON IF THE DECISION IS MADE TO BRING THEM TO CHARLESTON.

2. PLANES TRANSPORTING THE SURVIVORS WOULD LAND IN A RESTRICTED AREA OF CHARLESTON AFB. ACCESS TO THE TERMINAL FROM THE LANDING AREA, AND THE CUSTOMS AND IMMIGRATION AREAS, WOULD BE RESTRICTED. SURVIVORS WOULD MOVE IN A GROUP FROM THE TERMINAL TO TWO BUSES FOR TRANSPORT OFF THE BASE.

3. THE SURVIVORS WOULD BE HOUSED IN A MOTEL LOCATED ONE MILE FROM CHARLESTON AFB. THEY WOULD BE TRANSPORTED DIRECTLY TO THE MOTEL IN THE BUSES ACCOMPANIED BY MILITARY ESCORTS AND/OR FBI AGENTS AND LOCAL POLICE. UPON ARRIVAL AT THE MOTEL, THE SURVIVORS WOULD GO IMMEDIATELY TO A

PRIVATE ROOM SET UP FOR REGISTRATION. AFTER REGISTRATION, THE SURVIVORS WOULD BE ESCORTED DIRECTLY TO THEIR ROOMS.

4. THE MOTEL TO BE USED TO HOUSE THE SURVIVORS DOES NOT HAVE EATING FACILITIES AND PRESENT PLANS ARE TO ESCORT THE SURVIVORS AS A GROUP ABOUT 300 YARDS TO ANOTHER MOTEL FOR MEALS. THE POSSIBILITY THAT MEALS COULD BE CATERED IN SURVIVORS' ROOMS IS BEING EXPLORED.

5. HEW WILL ASSIGN ONE CASE WORKER FOR EACH FAMILY GROUP DURING THEIR STAY IN CHARLESTON. THE CASE WORKER WILL TAKE CARE OF ALL NEEDS OF THE FAMILY, INCLUDING ACCOMPANYING THEM TO CHARLESTON AIRPORT FOR BOARDING TO FINAL DESTINATION.

6. WE ARE EXPLORING THE POSSIBILITY OF SETTING UP A PRESS BRIEFING AREA IN CHARLESTON WHICH WOULD ALLOW ACCESS BY THE PRESS TO THOSE SURVIVORS WHO WERE WILLING TO BE INTERVIEWED. WE ARE REVIEWING THE HEW PREPARATION TO INSURE THAT THE PRIVACY WOULD BE PROTECTED OF THOSE SURVIVORS WHO DO NOT WISH TO BE INTERVIEWED. THESE ARRANGEMENTS APPEAR STRONG FROM GENERAL SECURITY VIEWPOINT. HOWEVER, GIVEN EAGERNESS OF THE PRESS ON THIS MATTER, THERE WOULD PROBABLY BE CONSIDERABLE TV AND PHOTO COVERAGE.

7. EMBASSY COMMENTS ON THESE PROPOSED ARRANGEMENTS IN LIGHT OF REFTTEL APPRECIATED. CHRISTOPHER

BT

#9132

NNNN

PAGE 01 PORT 0 03396 261515Z

ACTION ARA-15

26 Nov 78 15 39z

INFO OCT-01 ISO-00 FBIE-00 SY-05 SYE-00 SXC-00 CA-01
L-03 CG-00 DOTE-00 JUSE-00 CIAE-00 NSAE-00
INRE-00 SS-15 SSO-00 H-01 /051 W

Assoc. Dir.	
Dep. AD Adm.	
Dep. AD Inv.	
Asst. Dir.:	
Adm. Serv.	
Crim. Inv.	AA
Ident.	
Incl.	
Laboratory	
Legal Coun.	
Plan. & Insp.	
Rec. Mgnt.	
Tech. Servs.	
Training	
Public Affs. Off.	
Telephone Rm.	
Director's Sec'y	

OF IN... ON
COMMUN... ON
CIAE-00

Sen

-----089634 261519Z /14

ALL INFORMATION CONTAINED
HEREIN IS UNCLASSIFIED
DATE 9/24/92 BY 1048 DKM/MDM

0 261505Z NOV 78

FM AMEMBASSY PORT OF SPAIN
TO AMEMBASSY BRIDGETOWN NIACT IMMEDIATE
SECSTATE WASHDC NIACT IMMEDIATE 3285
INFO AMEMBASSY GEORGETOWN PRIORITY

FEDERAL GOVERNMENT

~~CONFIDENTIAL~~ PORT OF SPAIN 03396

(Handwritten initials)

E. O. 11652: GDS.
TAGS: CASC, OREF (RYAN, LEO), TD
SUBJECT: PEOPLES' TEMPLE MOVEMENT.

b6 per FBI
b7C

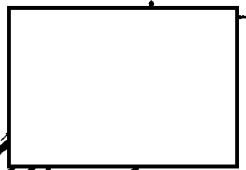

DE-51 REC-102 89-4286-40

1. "ALBATROSS III," VESSEL FLYING PANAMAIAN FLAG, DEPARTED
PORT OF TRINIDAD SPAIN FOR BARBADOS EVENING OF NOVEMBER 25, ETA
BRIDGETOWN APPROXIMATELY 6:00 P.M. NOVEMBER 26. CARGO IS
Guyana SOAP AND CAUSTIC SODA, BELIEVED TO BE CONSIGNED TO LEVER
BROS. AGENT IS ERIC HASSELL, CITIBANK, BRIDGETOWN. CREW
CONSISTS OF GUYANESE CAPTAIN AND EIGHT (8) SEAMEN WHO AP-
ARENTLY HAVE NO CONNECTION WITH PT. PT MEMBERS ON BOARD
ARE PHILIP BLAKEY (BRITISH CITIZEN) AND US CITIZEN CHARLES

Relayed to
87, 88
11/26/78
1/28/80

58 DEC 1 1978

2. TWO FBI AGENTS OUT OF SAN JUAN CURRENTLY ARE IN PORT OF SPAIN FOR PURPOSE OF QUESTIONING THE TWO TP MEMBERS WHO ARRIVED HERE ABOARD THE "ALBATROSS III" BUT DID NOT DEPART FOR BARBADOS (JANERO AND SWINNEY). THE AGENTS WOULD LIKE TO PROCEED TO BRIDGETOWN TOMORROW (MONDAY) TO QUESTION TOUCHETTE AND BLAKEY. PLEASE DETERMINE IF BARBADOS GOVERNMENT AGREEABLE TO VISIT AND ADVISE US, IF POSSIBLE TODAY, BY NIACT IMMEDIATE.

~~CONFIDENTIAL~~

~~CONFIDENTIAL~~

PAGE 02 PORT 0 03396 26QT15Z

3M IF YOU ARE ABLE, PLEASE DETERMINE PRECISELY WHERE THE "ALBATROSS III" PUTS UP. ALSO IF THERE IS TIME, IT WOULD BE EXTREMELY HELPFUL IF YOU COULD DETERMINE FROM TOUCHETTE, AND AT YOUR DISCRETION, BLAKEY (HE IS BRITISH CITIZEN WHO HAS VISITED IN THE US), WHETHER EITHER OR BOTH ARE WILLING TO TALK TO THE TWO AGENTS. FOX 2

~~CONFIDENTIAL~~

FBB 632

Assoc. Dir.	_____
Dep. AD Adm.	_____
Dep. AD Inv.	_____
Asst. Dir.:	<u>WJ</u> <u>ESP</u>
Adm. Serv.	_____
Crim. Inv.	_____
Ident.	_____
Intell.	_____
Laboratory	_____
Legal Coun.	_____
Plan. & Insp.	_____
Rec. Mgnt.	_____
Tech. Servs.	_____
Training	_____
Public Affs. Off.	_____
Telephone Rm.	_____
Director's Sec'y	_____

PAGE 01 260337Z

ACTION ARA-15

26 Nov 78
 RECEIVED
 FEDERAL BUREAU
 OF INVESTIGATION
 COMMUNICATIONS SECTION

INFO OCT-01 SSO-0P SCS-06 CA-01 PM-PT INR-10 INRE-00
 SS-15 FBIE-00 JUSE-00 L-PE PA-01 /057 W

FBI
 -----036307 260345Z /12

ALL INFORMATION CONTAINED
 HEREIN IS UNCLASSIFIED
 DATE 9/24/92 BY 1042DKA/ud/s

0200025Z NOV 78

FM COMUSJTF SOUTH/TIMEHRI AIRPORT GUYANA

TO JCS WASH DC

USCINCSO QUARRY HEIGHTS CZ

USCINCPAC MACDILL AFB FL

CINCPAC SCOTT AFB ILL

CSAF WASH DC

INFO SEC DEF WASH DC

SEC STATE WASH DC

WHITE HOUSE WASH DC//SITROOM//

CSA WASH DC

DIRNSA FT GEORGE G MEADE MD

WQ AF OC MCGUIRE AFB NJ

AF MPC RANDOLPH AFB TX//MPCCM//

CDR 1ST CORP SUPPORT COMMAND FT BRAGG NC

USCINCPAC FT MCPHERSON GEORGIA

43Y MAW DOVER AFB DE//SVM//

436 ABG DOVER AFB DE//SVM//

CDR XVIII ABN CORPS FT BRAGG NC

ARRS SCOTT AFB IL/XCAT//

Leo J. Ryan

FEDERAL GOVERNMENT

9

b6 per F
b7C

REC-102

89-4286 - 402

Declass per DOD let 9/16/2005
65179 DMH/ST/bpg

58 NOV 30 1978

39 ARRW EGLIN AFB FL //CAT//

41 RWRW MCCLELLAN AFB CA//CAT//

ROOSEVELT ROADS SAN JUAN, PR//SAR MISSION CONTROL//

AMEMBASSY GEORGETOWN GUYANA

~~CONFIDENTIAL~~

SITUATION REPORT NUMBER FIVE AS OF 262130Z NOV 78

- (U) 1. ~~(C)~~ SITUATION. FORWARD OPERATING BASES AT JONESTOWN AND MATTHEWS RIDGE ARE IN THE PROCESS OF BEING DISMANTLED AND PERSONNEL AND

~~CONFIDENTIAL~~

~~CONFIDENTIAL~~

434

PAGE 02

260337Z

EQUIPMENT RETROGRADED TO THIS LOCATION. ALL HUMAN REMAINS HAVE BEEN

EVACUATED FROM JONESTOWN. FINAL COUNT FROM THAT LOCATION IS 909 DEAD. THE 5 ADDITIONAL VICTIMS EVACUATED FROM GEORGETOWN BRING THIS TOTAL TO 914 DEAD.

- (U) 2. ~~(C)~~ INTELLIGENCE.

A. COORDINATION WITH GUYANA NATIONAL POLICE REVEALS THAT THE FOLLOWING WEAPONS WERE CONFISCATED BY THEM AT JONESTOWN.

(1) 10 PISTOLS

(2) 11 HIPOWERED RIFLES (MWRE TO .308 CAL)

(3) 3 .22 CAL RIFLES

(4) 7 1W GAUGE SHOTGUNS

2

KTL 1 FLARE LAUNCHER

B. THE NUMBER OF VICTIMS AND KNOWN SURVIVORS REDUCES THE POSSIBILITY OF THERE BEING ANY NUMBER OF ADDITIONAL SURVIVORS. THE NEGATIVE RESULTS OF ALL SEARCH EFFORTS TO DATE ALL SUPPORTS THIS CONCLUSION.

(U) 3. ~~08~~ EVALUATION OF SIGNIFICANT FACTORS.

A. PERSONNEL STATUS REPORT

(1) SOUTHCOM

COMPONENT/OFF/EM

ARMY / 13 / 61

USAF / 3 / 14

NAVY / 1 / 0

(2) REDCOM

UNIT /OFF/EM

HQ COSCOM / 9/14

396 MED CLEARING / 4/17

53PTH GRAVE REG DET/ 2/28

498TH MED CO / 10/20

~~CONFIDENTIAL~~

~~CONFIDENTIAL~~

PAGE 03

260337Z

TOTAL / 25/79

(3) OTHER UNITS

MAC/17/69

PAGE FOUR RUCJBBB0001 ~~CONFIDENTIAL~~

JKSE/3/19

114TH AVN CO/5/6

352 AVN CO/2/4

(4) FORWARD ELEMENTS ARE IN THE PROCESS OF RELOCATING TO GEORGETOWN. AT THIS TIME, RELOCATION TO THE REAR AREA IS ESTIMATED AT APPROX 80 PER CENT COMPLETED.

B. MAC MISSIONSKREAD IN FIVE COLUMNS).

MSN NO	AIRCRAFT	TAIL NO	BLOCKTIME	TAKE OFF TIME
1593X0	C-130	60531	250025Z	250205Z
1032-PQ	C-141	70019	250525Z	250655Z
1034-01	C-141	50250	250720Z	251000Z
1035-01	C-141	70021	251455Z	251742Z
1033-01	C-141	50258	251950Z	

C/ LOGISTICS.

NO REMAINING SIGNIFICANT LOGISTICAL PROBLEMS. IT HAS BEEN POSSIBLE TO CONTINUE TO PLACE MORE THAN ONE HUMAN REMAINS IN ONE TRANSFER CASE. THE REMAINING EMPTY TRANSFER CASES ON HAND WILL BE REDEPLOYED TO CONUS.

D. PUBLIC AFFAIRS AFTER COORDINATION WITH THE AMERICAN EMBASSY AND GOVERNMENT OF GUYANA OFFICIALS PERMISSION WAS GRANTED TO TAKE A

4
PRESS TEAM TO JONESTOWN THIS AFTERNOON. THIS TEAM IS TRANSPORTED

PAGE FIVE RUCJBBB0000 ~~CONFIDENTIAL~~

TO AND FROM THE JONESTOWN AREA BY UH-1H HELICOPTER.

- (U) 4. ~~CONFIDENTIAL~~ OPERATIONAL SUMMARY. FLIGHT OPERATIONS COMMENCED AT QQPPZ WITH THE LAUNCH OF 2 HH-53'S. FIVE UH-1H'S WERE LAUNCHED AT 1130Z. MAC MISSION 1034-PQ DEPARTED TIMEHRI AT 251000Z NOV WITH 110 HUMAN RE-

~~CONFIDENTIAL~~

5

~~CONFIDENTIAL~~

PAGE 04

260337Z

MAINS; 94 UNIDENTIFIED/16 IDENTIFIED. MAC MISSION 1030-08 DEPARTED TIMEHRI AT 251745Z NOV WITH 197 HUMAN REMAINS; 189 UNIDENTIFIED/8 IDENTIFIED. THE ADDITIONAL BODY COUNT CREATED A TRANSFER CASE PROBLEM, BUT THE RESPONSE WAS TIMELY AND APPRECIATIVE. MISSION 1033-01 ARRIVED 2300Z WITH 144 TRANSFER CASES AND SQA1593 AT 2135Z WITH 15 TRANSFER CASES. MISSION 1030-10 ARRIVING AT 260740Z NOV WILL EVACUATE THE LAST HUMAN REMAINS FROM GUYANA. SEARCH WAS CONDUCTED IN JONESTOWN VICINITY BY UH-1H'S UTILIZING BULL HORNS. ONE HH-53 WAS DOWN FOR BOOM RETRACTION MAINTENANCE AND WAS O.R. AT 1415Z. ALL AIRCRAFT ARE OPERATIONAL READY.

(U) T. ~~100~~ COMMANDERS PLANS. REDEPLOYMENT PLANNING WELL UNDERWAY AND WILL COMMENCE WITH THE RETURN OF SOME PERSONNEL AND EQUIPMENT TO THE CANAL ZONE THIS EVENING ON A C-130. THE FIRST REDEPLOYMENT C-141 IS DUE AT THIS LOCATION AT 260600Z NOV 78. SREDEPLOYMENT PLAN PASSED BY SEPERATE ACTION. LAST USJTF SOUTH ELEMENTS WILL DEPART GUYANA ON 27 NOV 78M LAST BODIES SCHEDULED OUT OF TIMEHYII ON MAC MSN IPEEAPQN TAIL NO 50268, AT APPROXIMATELY 262335Z NOV 78.

GDS-86

6

BU0001 3301005Z

CO HQ SF MM

DE BU

R 261905Z NOV 78

FM BUFFALO (89-56) (P)

26 Nov 78

913

RECEIVED
FEDERAL BUREAU
OF INVESTIGATION
COMMUNICATIONS SECTION

Assoc. Dir.	_____
Dep. AD Adm.	_____
Dep. AD Inv.	_____
Asst. Dir.:	
Adm. Serv.	_____
Crim. Inv.	_____
Ident.	_____
Insp.	_____
Laboratory	_____
Legal Coun.	_____
Plan. & Insp.	_____
Rec. Mgmt.	_____
Tech. Servs.	_____
Training	_____
Public Affs. Off.	_____
Telephone Rm.	_____
Director's Sec'y	_____

TO DIRECTOR (MAJOR CASE 16) (IMMEDIATE)

SAN FRANCISCO (89-250) (IMMEDIATE)

MIAMI (IMMEDIATE)

BT

UNCLAS

RYMUR

ALL INFORMATION CONTAINED
HEREIN IS UNCLASSIFIED
DATE 9/24/92 BY 1043 DCH/MDM

RE WFO TELETYPE TO DIRECTOR, 11/24/78 AND BUFFALO TELCALL
TO MIAMI, 11/25/78. (u)

FOR INFO OF MIAMI, REFERENCED TELETYPE STATED CONTACT
WITH FEDERAL COMMUNICATIONS COMMISSION (FCC) DETERMINED SEVERAL
LICENSEES WITH HAM RADIOS HAD BEEN IN CONTACT WITH THE PEOPLES
TEMPLE IN JONESTOWN, GUYANA, CALL SIGN WB 6MID/8R3. A

FACSIMILE WILL BE FORWARDED TO MIAMI FOR REVIEW. REC-102 89-4286-403

ONE OF THESE LICENSEES WAS IDENTIFIED AS

[REDACTED] CONESUS, NEW YORK, OPERATOR OF [REDACTED]

INVESTIGATION AT ROCHESTER, NEW YORK, 11/24-25/78 DETERMINED

b6
b7C

58 NOV 30 1978

6 [REDACTED] [Handwritten signature]

PAGE TWO, BU 89-56 UNCLAS

[REDACTED] MD, FORMER RESIDENCE [REDACTED]
CONESUS, NEW YORK, BUSINESS ADDRESS 318 SOUTH GOODMAN STREET,
ROCHESTER, NEW YORK, RETIRED FROM PRACTICE AND DEPARTED
ROCHESTER, NEW YORK 11/20/78 WITH WIFE. [REDACTED] WAS TRAVELING
BY AUTOMOBILE AND PLANNED TO RELOCATE AT [REDACTED]
PORT ST. LUCY, FLORIDA 33452.

MIAMI AT PORT ST. LUCY, FLORIDA: WILL CONTACT [REDACTED]
AND DETERMINE THE FREQUENCY AND EXTENT OF CONTACTS WITH THE
PEOPLES TEMPLE AND HIS KNOWLEDGE OF CONDITIONS WHICH EXISTED
THERE PRIOR TO AND DURING CONGRESSMAN RYAN'S INSPECTION. (u)

BT

b6
b7C

#

2

SF0813 3301753"

26 Nov 78 18 02 z

OO HQ

DE SA 01

0 26171Z NOV 7

FM SAN FRANCISCO (89-250) (P) (SQ. 10)

TO DIRECTOR (89-4286) IMMEDIATE

BT

UNCLAS

RYMUR

RECEIVED
FEDERAL BUREAU
OF INVESTIGATION
COMMUNICATIONS SECTION

Assoc. Dir.	
Dep. AD Adm.	
Dep. AD Inv.	
Asst. Dir.:	
Adm. Serv.	<i>W</i>
Crim. Inv.	<i>W</i>
Ident.	<i>W</i>
Int'l.	
Laboratory	
Legal Coun.	
Plan. & Insp.	
Rec. Mgmt.	
Tech. Servs.	
Training	
Public Affs. Off.	
Telephone Rm.	
Director's Sec'y	

ALL INFORMATION CONTAINED
HEREIN IS UNCLASSIFIED
DATE 9/21/92 BY 1049 DKM/Hdb

Handwritten signature/initials

RE SAN FRANCISCO TELEPHONE CALL TO BUREAU, NOVEMBER 25, 1978, PM. (u)

ON LATE EVENING OF NOVEMBER 25, 1978, [redacted]

[redacted] ASSISTANT TO CHARLES GARRY, TELEPHONICALLY ADVISED

THAT SHE HEARD LOCAL NEWS ANNOUNCEMENT FROM MILITARY PERSONNEL

AT DOVER AIR FORCE BASE REQUESTING FRIENDS, RELATIVES, AND DOCTORS HAVING PHOTOGRAPHS OR MEDICAL RECORDS TO ASSIST IN

REC-102 89-4286-404

IDENTIFICATION OF DECEASED PEOPLE'S TEMPLE (PT) MEMBERS TO BE NOV 28 1978

FORWARDED TO DOVER AIR FORCE BASE. [redacted] ADVISED THAT IT WAS

PT'S POLICY TO HAVE ALL RESIDENCE IN JONESTOWN TO BRING WITH (u)

6- [redacted] *Relayed to State 11/26/78*

58 NOV 30 1978

b6
b7c

PAGE TWO SF 89-250 UNCLAS

THEM ALL AVAILABLE MEDICAL AND DENTAL RECORDS. SHE ADVISED JONESTOWN MAINTAINED THESE RECORDS AT TEMPLE CLINIC IN JONESTOWN. SHE ALSO ADVISED ONE DENTIST, NAME UNKNOWN, IN JONESTOWN HANDLED ALL DENTAL WORK FOR JONESTOWN RESIDENTS. (u)

STATE DEPARTMENT SHOULD BE MADE AWARE OF ALL ABOVE INFORMATION AND EFFORTS MADE TO OBTAIN MEDICAL RECORDS FROM JONESTOWN AND GEORGETOWN, IF AVAILABLE. (u)

BT

~~CONFIDENTIAL~~

FBB662

PAGE 01 PORT 0 03397 261516Z

ACTION ARA-15

26 Nov 78 15 39z
FEDERAL BUREAU OF INVESTIGATION
COMMUNICATIONS SECTION

INFO OCT-01 ISO-00 FBIE-00 SS-15 SSO-PP SY-05 SYE-00

Assoc. Dir.	
Dep. AD Adm.	
Dep. AD Inv.	
Asst. Dir.:	
Adm. Serv.	
Crim. Inv.	
Ident.	
Intell.	
Laboratory	
Legal Coun.	
Plan. & Insp.	
Rec. Mgmt.	
Tech. Servs.	
Training	
Public Affs. Off.	
Telephone Rm.	
Director's Sec'y	

JUSE-0P L-03 /039 W

-----AAAAAPIOYRP 261521Z /14

261512Z NOV 78

FM AMEMBASSY PORT OF SPAIN
TO AMEMBASSY BRIDGETOWN NIACT IMMEDIATE
INFO SECSTATE WASHDC PRIORITY 3286

FBI
ALL INFORMATION CONTAINED
HEREIN IS UNCLASSIFIED
DATE 9/21/92 BY 1040CKM/MLA

FEDERAL GOVERNMENT

(9)

~~CONFIDENTIAL~~ PORT OF SPAIN 03397

E. O. 11652: GDS.
TAGS: CASC, OREP (RYAN, LEO), TD
SUBJECT: PEOPLES' TEMPLE MOVEMENT.

REC-102

REFERENCE: PORT OF SPAIN 3396

89-4286-405



1. IF GOVERNMENT OF BARBADOS APPROVES OF THE VISIT, FBI AGENTS [] AND [] WILL BE CARRYING ONE S&W MODEL 60 REVOLVER SERIAL R-102-039 AND ONE COLT 38 REVOLVER DETECTIVE SPECIAL SERIAL 664533.

b6 per FBI
b7C

Relayed
87, 88
11-20-78
LRS:bjg

Declass per State let 2/16/05
UC65179DMH/ST/bpg

2. PLEASE ARRANGE ENTRY. FOX

50 DEC 1 1978

BA0001 3300450Z

OO HI SF

DE BA

O 260430Z NOV 78

FM BALTIMORE (89-173)

TO DIRECTOR IMMEDIATE

SAN FRANCISCO IMMEDIATE

26 Nov 78

5 57z

RECEIVED
FEDERAL BUREAU
OF INVESTIGATION
COMMUNICATIONS SECTION

Assoc. Dir.	_____
Dep. AD Adm.	_____
Dep. AD Inv.	_____
Asst. Dir.:	_____
Adm. Serv.	_____
Crim. Inv.	_____
Ident.	_____
Intell.	_____
Laboratory	_____
Legal Coun.	_____
Plan. & Insp.	_____
Rec. Mgnt.	_____
Tech. Servs.	_____
Training	_____
Public Affs. Off.	_____
Telephone Rm.	_____
Director's Sec'y	_____

BT

ALL INFORMATION CONTAINED
HEREIN IS UNCLASSIFIED
DATE 9/24/92 BY 1049 DKM/ndm

UNCLAS
RYMUR

REFERENCE WASHINGTON FIELD TELETYPE TO BUREAU NOVEMBER 24 1978. (u)

EFFORTS TO LOCATE AND INTERVIEW [REDACTED] HAM OPERATOR

[REDACTED] POTOMAC MARYLAND ON 11-24, 25, 26-78 UNPRODUCTIVE.

IS CONCEIVABLE THAT [REDACTED] IS AWAY FOR THANKSGIVING HOLIDAY. (u)

BALTIMORE WILL CONTINUE EFFORTS TO INTERVIEW WEEK OF 11-27-78. (u)

REC-102

89-4286-406

NOV 22 1978

BT

[REDACTED] b6 b7C
[REDACTED] [Signature]

58 NOV 30 1978

Assoc. Dir.	_____
Dep. AD Adm.	_____
Dep. AD Inv.	_____
Asst. Dir.:	
Adm. Serv.	_____
Crim. Inv.	_____
Ident.	_____
Intell.	_____
Laboratory	_____
Legal Coun.	_____
Plan. & Insp.	_____
Rec. Mgnt.	_____
Tech. Servs.	_____
Training	_____
Public Affs. Off.	_____
Telephone Rm.	_____
Director's Sec'y	_____

25 Nov 78 02 25z

RECEIVED
FEDERAL BUREAU
OF INVESTIGATION
COMMUNICATIONS SECTION

VZCZCWF0821
PP HQ SC SF
DE WF #0027 3290208
ZNR UUUUU

P 2400Z 25Z NOV 78

FM FBI WASHINGTON FIELD (89-570) (P)
TO DIRECTOR FBI PRIORITY
FBI SACREMENTO PRIORITY
FBI SAN FRANCISCO (89-250) PRIORITY (SF VIA FBIHQ)

ALL INFORMATION CONTAINED
HEREIN IS UNCLASSIFIED
DATE 9/24/92 BY 10480/kaj/mch

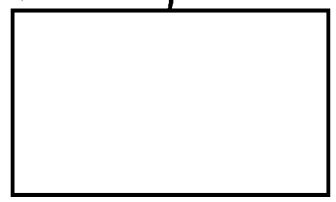

b6
b7C

BT

UNCLAS
RYMUR

RE WFO TEL TO BUREAU, NOVEMBER 22, 1978, BUREAU TEL
TO WFO, NOVEMBER 22, 1978., AND SFTTEL TO BUREAU, NOVEMBER 22,
1978. (u)

FOR THE INFORMATION OF THE BUREAU, AND RECEIVING OFFICES,
ON NOVEMBER 23, 1978, A LIST OF APPROXIMATELY 900 NAMES BELIEVED
TO BE THOSE INDIVIDUALS OF THE PEOPLES TEMPLE GUYANA OPERATION,
WAS OBTAINED FROM THE STATE DEPARTMENT COMMAND CENTER, WASHINGTON,
D. C. THIS LIST HAD BEEN PREPARED FROM GUYANESE IMMIGRATION
RECORDS, AND IS BELIEVED TO BE THE SAME LIST ALSO IN
POSSESSION OF FBIHQ.

REC-102 89-4286-407 23 NOV 28 1978

RECEIVED IN
SF

53 DEC 1 1978

W
PAGE TWO DE WF 0027 UNCLAS

ON NOVEMBER 24, 1978, THESE NAMES WERE SEARCHED THROUGH WASHINGTON FIELD OFFICE INDICES AND A FILE REVIEW IS NOW BEING CONDUCTED. (u)

ADDITIONALLY ON NOVEMBER 24, 1978, [REDACTED] LEGAL DIVISION, PASSPORT OFFICE, UNITED STATES DEPARTMENT OF STATE (USDS), ADVISED THAT SHE WAS IN THE PROCESS OF INITIATING A SEARCH ON NOVEMBER 25, 1978, OF THE PASSPORT FILES OF ALL PERSONS WHOSE NAMES APPEAR ON THE AFOREMENTIONED LIST. THIS SEARCH WILL INVOLVE APPROXIMATELY 15 STATE DEPARTMENT REPRESENTATIVES AFTER WHICH THESE PASSPORT APPLICATIONS WILL BE MADE AVAILABLE TO WASHINGTON FIELD. IN CONNECTION WITH THIS, WASHINGTON FIELD IS PREPARING 900 FILE REQUEST LETTERS THAT WILL BE NECESSARY IN ORDER TO INITIATE A REVIEW BY FBI PERSONNEL.

b6
b7c

REFERENCED SAN FRANCISCO COMMUNICATION INDICATED THE EXISTENCE OF A LIST OF ALL PEOPLE IN JONESTOWN IN OCTOBER, 1977, WHICH HAD BEEN COMPILED BY [REDACTED], BUREAU OF SPECIAL CONSULAR SERVICES, USDS. STEPHEN DOBRUNCHUK, CHIEF, SPECIAL CONSULAR SERVICES (SCS), ADVISED THAT [REDACTED] HAD BEEN TRANSFERRED FROM HIS UNIT TO SAUDIA ARABIA IN APRIL THIS YEAR, AND DISPUTED THE EXISTENCE OF SUCH A LIST, ADDING THAT THERE IS NO COMPULSORY REGISTRATION OF AMERICAN CITIZENS WITH USDS, WHO ARE OVERSEAS.

PAGE THREE DE WF 0027 UNCLAS

ADDITIONALLY CONTACT WAS MADE WITH [REDACTED] WHICH
REVEALED THAT SHE HAS NO DIRECT KNOWLEDGE REGARDING ANY THREATS,
AGAINST STEVEN, ANTHONY OR ANN KATARSIS. [REDACTED] ADVISED
THAT SHE HAD LEARNED FROM STEVEN KATARSIS THAT THESE ALLEGED
THREATS WERE RECEIVED BY THE HOSPITAL AT ROOSEVELT ROADS,
SAN JUAN, PUERTO RICO.

ARMED AND DANGEROUS; SUICIDAL TENDENCIES. (u)

BT

#0027

b6
b7c

63

NAVY 73FBA117

00 RUEHFB

DE RUEKJCS #2762 3302115

ZNY CCCCC

0 262102Z NOV 78

FM JCS WASHINGTON DC//J3//

TO RUEHC/SECSTATE WASHINGTON DC//GUYANA TASK FORCE//

INFO RULPALJ/USCINCSO QUARRY HEIGHTS

RUCJAAA/USCINCREC MACDILL AFB FL

RUCIMAA/CINCMAC SCOTT AFB IL

RUEHFB/FBI WASHINGTON DC

RUEAUSA/DEPT OF HEALTH ED AND WELFARE WASHINGTON DC

RUEBWJA/DEPT OF JUSTICE WASHINGTON DC

RUEBHBA/2 IAF OC MCGUIRE AFB NJ

RUESON/COMUSJTF GY

RUCLSLA/437MAW CHARLESTON AFB SC

RUEADWD/CSA WASHINGTON DC REC-102

RUEAHQA /HQ USAF WASHINGTON DC

RUENAAA/CNO WASHINGTON DC

RUEACMC/CMC WASHINGTON DC

RUESON/AMEMB GEORGETOWN GY

RUWTBGR/ARRS SCOTT AFB IL//CC//

RUCLBMA/39ARRW EGLIN AFB FL

BT

~~CONFIDENTIAL~~ 4523

58 NOV 30 1978

26 Nov 78 21
RECEIVED
FEDERAL BUREAU
OF INVESTIGATION
COMMUNICATIONS SECTION

Assoc. Dir.	
Dep. AD Adm.	
Dep. AD Inv.	
Asst. Dir.:	
Adm. Serv.	
Crim. Inv.	
Ident.	
Intell.	
Laboratory	
Legal Coun.	
Plan. & Insp.	
Rec. Mgmt.	
Tech. Servs.	
Training	
Public Affs. Off.	
Telephone Rm.	
Director's Sec'y	

ALL INFORMATION CONTAINED
HEREIN IS UNCLASSIFIED
DATE 9/24/92 BY 1048 DIC/ML/ldm

FEDERAL GOVERNMENT

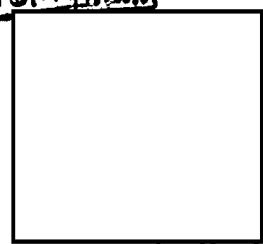

b6 per FB
b7C

Leo J Ryan

89-4286-408

23 NOV 27 1978

Declassified per DOD letter 7/21/2005
65179DMH/ST/bpg

SUBJ: RETURN OF PEOPLE'S TEMPLE SURVIVORS

- (U) 1. ~~THE~~ THE SITUATION REGARDING LEGAL STATUS AND RETURN TO CONUS OF US TEMPLE MEMBER SURVIVORS HAS DEVELOPED INTO UNKNOWN DIPLOMATIC DELAYS AND LAW ENFORCEMENT REQUIREMENTS. IT DOES NOT APPEAR THAT THE GUYANIAN GOVERNMENT IS GOING TO RELEASE THE GROUPS OF SURVIVORS WITHIN THE NEXT 72 HOURS. THERE ARE SOME INDICATIONS THAT THE "LAMAR GROUP" CULT SURVIVORS MAY NOT BE RELEASED UNTIL SOME TIME IN DECEMBER.
- (U) 2. ~~IT~~ IT IS PLANNED TO REDEPLOY ALL US MILITARY ELEMENTS FROM GUYANA BY END OF 27 NOV 78 EXCEPT FOR THE AIRLIFT CONTROL ELEMENT (ALCE) (ABOUT TWENTY SEVEN PERSONNEL) NECESSARY TO RETURN CULT SURVIVORS AND THE HELICOPTERS WITH PERSONNEL PROVIDING SUPPORT TO AMEMB GUYANA.
- (U) 3. ~~IT~~ IT APPEARS PRUDENT TO REDEPLOY THE ALCE ON 27 NOV 78 SINCE CULT SURVIVORS WILL NOT BE RELEASED WITHIN 72 HOURS. ALTHOUGH COMMERCIAL AIR IS PREFERRED AND AVAILABLE, IF MILITARY AIRLIFT IS REQUIRED SPECIAL MISSION AIRCRAFT AND REQUIRED SECURITY PERSONNEL CAN BE READIED FOR DEPLOYMENT WITHIN 24 HOURS.

PLEASE ADVISE SOONEST.

GDS-84

BT

2

LIMITED OFFICIAL USE

BB679

Assoc. Dir.	
Dep. AD Adm.	
Dep. AD Inv.	
Asst. Dir.:	
Adm. Serv.	<input checked="" type="checkbox"/>
Crim. Inv.	<input checked="" type="checkbox"/>
Ident.	
Intell.	
Laboratory	
Legal Coun.	
Plan. & Insp.	
Rec. Mgmt.	
Tech. Servs.	
Training	
Public Affs. Off.	
Telephone Rm.	
Director's Sec'y	

PAGE 01

GEORGE 03952 262W1871

26 Nov 78 22

ACTION ARA-1"

RECEIVED
FEDERAL BUREAU
OF INVESTIGATION
COMMUNICATIONS SECTION

INFO OCT-01 ISO-00 SCS-06 CA-01 L-03 H-01 FBIE-00

JUSE-00 SY-05 USSS-00 CIAE-00 DODE-00 INR-10

NSAE-00 PA-01 SP-02 NSCE-00 SSO-00 ICAE-00

INRE-00 /045 W

-----AAAPOPYPO WY223Z /UE

O WYWQRPZ NOV UI

FM AMEMBASSY GEORGETOWN

TO SECSTATE WASHDC IMMEDIATE 8222

b6 per FBI
b7C
[Handwritten initials]

FEDERAL GOVERNMENT

ALL INFORMATION CONTAINED
HEREIN IS UNCLASSIFIED
DATE 9/24/92 BY 1049 DCA/MLM

LIMITED OFFICIAL USE GEORGETOWN 30TW

E.O. 11652: N/A

REC-102

89-4286-409

TAGSC CASC OREP (RYAN, LEGL GY

SUBJECT: PRESS INQUIRIES ON PEOPLES TEMPLE

23 NOV 27 1978

REF: STATE 299148

[Handwritten initials]

1. AMBASSADOR BURKE NEVER MET REVEREND JIM JONES EITHER OFFICIALLY OR SOCIALLY. AS FAR AS IS KNOWN, JONES WAS NEVER IN GEORGETOWN DURING THE

58 DEC 1978

'PERIOD' SINCE AMBASSADOR'S ARRIVAL IN SEPTEMBER 1977. AS INDICATED IN
PARA ONE REFTTEL, MRS JONES PAID A COURTESY CALL ON AMBASSADOR AT
3 PM MONDAY, JUNE 26. THIS WAS THEIR ONLY MEETING.

2. EMBASSY HAS NO RECORD OF EVER HAVING RECEIVED THE BLAKEY AFFIDAVIT
OF JUNE 15, 1978 FROM THE DEPARTMENT. EMBASSY DID, HOWEVER, RECEIVE
A COPY OF THE AFFIDAVIT DIRECTLY FROM ONE OF THE "CONCERNED RELATIVES"

GROUP IN A COMMUNICATION POSTMARKED AUGUST 11. SAME INDIVIDUAL IS
ALSO KNOWN TO HAVE ADDRESSED A LETTER TO PRIME MINISTER REGARDING
CONDITIONS IN JONESTOWN. THE AFFIDAVIT WAS NOT DISCUSSED WITH THE
GOG.

BURKE

LIMITED OFFICIAL USE

~~CONFIDENTIAL~~

FBB667

Assoc. Dir.	_____
Dep. AD Adm.	_____
Dep. AD Inv.	_____
Asst. Dir.:	
Adm. Serv.	_____
Crim. Inv.	_____
Ident.	_____
Inte'l.	_____
Laboratory	_____
Legal Coun.	_____
Plan. & Insp.	_____
Rec. Mgmt.	_____
Tech. Servs.	_____
Training	_____
Public Affs. Off.	_____
Telephone Rm.	_____
Director's Sec'y	_____

PAGE 01 261819Z

ACTION ARA-15

26 Nov 78 18 30z

INFO OCT-PQ SCS-06 INR-10 ~~CDNR-00~~ ~~SS-00~~ ~~SS-00~~ SSO-00 SY-05
 SYE-00 H-01 FBIE-00 CIAE-00 CA-01 USSS-00 AID-05
 NSCE-00 CCO-00 OC-PY JUSE-00 NSAE-00 IC AE-00 PA-HQ
 TRSE-00 CG-00 L-03 DOTE-00 /069 W

*Let
Lui*

-----AAAAAAPOPQYY 261823Z /14

O 260726Z NOV 78
 FM JCS WASHINGTON DC//J3//
 TO SECSTATE WASHINGTON DC
 USCINCSO QUARRY HEIGHTS CZ

FEDERAL GOVERNMENT ALL INFORMATION CONTAINED
 HEREIN IS UNCLASSIFIED
 DATE 9/24/96 BY 1049 DKN/mbu

Leo J Ryan

~~CONFIDENTIAL~~ 4465

SUBJ: FINAL SEARCH OF JONESTOWN SETTLEMENT AREA (U)

REFS: A. SECSTATE 260203Z NOV 78 REG-102 89-4286-4/10
 B. TELECON COL GARRISON, USMC, JCS/CAT TEAM CHIEF
 COL GORDON, USA, COMUSJTF BY OF 260300Z NOV 78

- (U) 1. ~~BY~~ BY SECSTATE 260203Z NOV 78, A FINAL, DAYLIGHT SEARCH FOR BODIES IN JONESTOWN SETTLEMENT AND SURROUNDING CLEARED AREAS WAS REQUESTED.
- (U) 2. ~~BY~~ BY REF B IT WAS REPORTED THAT A THOROUGH SEARCH OF SUBJECT AREA WAS CONDUCTED DURING DAYLIGHT HOURS WITH NEGATIVE RESULTS. AMBASSADOR BURKE WAS SO NOTIFIED.

GDS 84

58 NOV 30 1978

Declassified per DOD letter 7/21/2005
 65179DMH/ST/bpg

ds
 b6 per FBI
 b7C

EOT

~~CONFIDENTIAL~~

FBB625

Assoc. Dir.	
Dep. AD Adm.	
Dep. AD Inv.	
Asst. Dir.:	
Adm.	
Crim. Inv.	<input checked="" type="checkbox"/>
Ident.	
Intell.	
Laboratory	
Legal Coun.	
Plan. & Insp.	
Rec. Mgmt.	
Tech. Servs.	
Training	
Public Affs. Off.	
Telephone Rm.	
Director's Sec'y	

PAGE 01

GEORGE 03938

26 Nov 78 (01332)

ACTION L-03

FEDERAL BUREAU OF INVESTIGATION COMMUNICATIONS SECTION

INFO OCT-01 ARA-11 ISO-00 SCS-06 CA-01 FBIE-00 JUSE-00
 H-21 CIAE-00 INR-QP WNSAE-00 SS-15 NSCE-00 SSO-00
 INRE-00 /048 W

ALL INFORMATION CONTAINED
 HEREIN IS UNCLASSIFIED
 DATE 9/29/02 BY 1046 DCA/ADM

-----AAAAAAP IRQUE 280105Z 78

252240Z NOV 78

FEDERAL GOVERNMENT

FM AMEMBASSY GEORGETOWN

TO SECSTATE WASHDC NIACE IMMEDIATE 0208

Leo S Ryan

b6 per FBI
b7c

~~CONFIDENTIAL~~ GEORGETOWN 3938

E.O. 11652: GDS

DE-511

REC-102

89-4286-411

TAGS: CASC OREP GY AFSP

23 NOV 27 1978

SUBJECT: ENGAGEMENT OF LOCAL LEGAL COUNSEL TO ASSIST USG IN
DISCHARGING ITS RESPONSIBILITIES IN CONNECTION WITH DISASTER

AT JONESTOWN AND ESTATES OF THE DECEASED AMERICAN CITIZENS.

Declass per State let 2/16/05
UC65179DMH/ST/bpg

58 DEC 1 1978 REF: STATE 296352 B) STATE 296909

1. IN VIEW OF AUTHORITY CONTAINED REFERENCE A AND B,
EMBASSY HAS GIVEN MUCH THOUGHT TO BEST POSSIBLE LEGAL TALENT,
WHICH MIGHT BE ENGAGED TO ASSIST IN OUR EFFORT TO IDENTIFY
(1) THE MAGNITUDE OF THE GUYANESE-BASED ASSETS OF THE PEOPLES
TEMPLE, AND (2) THE APPLICATION OF LOCAL LAW TO THE LIQUIDATION
OF THE PERSONAL ESTATES LEFT BY JONES AND THE INDIVIDUAL
MEMBERS OF PEOPLES TEMPLE WHO DIED NOVEMBER 18 AT JONESTOWN.

2. BEFORE CONSIDERING THE ENGAGEMENT OF ANY LOCAL COUNSEL
EMBASSY WAS OBLIGED TO DISCARD THE NAMES OF MANY COMPETENT
LAWYERS WHO HAVE BEEN ACTIVE POLITICALLY IN THE RECENT PAST
BECAUSE OBVIOUSLY ANY LEGAL COUNSEL WHOM WE ENGAGE MUST
HAVE IMMEDIATE ACCESS TO THE VARIOUS OFFICES OF THE GOVT OF
GUYANA IF HE IS TO DO THE JOB PROMPTLY AND COMPLETELY. IT
WAS ALSO NECESSARY THAT ANY COUNSEL WITH WHOM WE BROACHED
THE SUBJECT NOT HAVE A CURRENT LEGAL CONNECTION WITH THE

~~CONFIDENTIAL~~

2

PEOPLES TEMPLE. WITH THESE CONSIDERATIONS IN MIND THE
 AMBASSADOR MET AT NOON NOVEMBER 25 WITH [REDACTED]
 ONE OF THE BEST-KNOWN ATTORNEYS IN GEORGETOWN AND A
 MAN WHO HAS SPECIALIZED IN THE PAST IN CIVIL LAW, AND
 WHO HAS REPRESENTED SUCH AMERICAN FIRMS AS REYNOLDS
 AND TEXACO IN THEIR RELATIONSHIPS WITH THE GOVERNMENT
 OF GUYANA. [REDACTED] FIRM, WHICH INCLUDES HIS ELDER
 BROTHER, SIR LIONEL, IS ONE OF THE OLDEST AND MOST
 PRESTIGIOUS LAW FIRMS IN GEORGETOWN.

b6 Per FBI
b7C

3. DURING THE CONVERSATION WITH [REDACTED], IT WAS MADE
 CLEAR THAT DUE TO THE DIMENSIONS OF THE PROBLEM WHICH
 HAD BEEN CREATED BY THE MULTIPLE MURDERS/SUICIDES AT
 JONESTOWN, IT WAS MOST IMPORTANT AT THE OUTSET TO
 ESTABLISH CERTAIN FUNDAMENTAL POINTS:

A) THE LEGAL RELATIONSHIP BETWEEN THE GOG AND JIM
 JONES AND THE PEOPLES TEMPLE,

B) WHETHER OR NOT JONESTOWN EXISTED WITHIN GUYANA
 AS A CORPORATE ENTITY OR AS SOME OTHER FORM OF LEGAL
 PERSONALITY.

C) WHAT THE TOTAL ASSETS IN GUYANA MIGHT BE BOTH
 IN TERMS OF REAL PROPERTY AND BANK ACCOUNTS.

4. THE AMBASSADOR EXPLAINED TO [REDACTED] THAT AS OF NOW WE HAD AUTHORITY 1) TO MAKE THIS PRELIMINARY SOUNDING WITH HIM TO FIND OUT FROM HIM IF HE, [REDACTED] WERE LEGALLY INHIBITED FROM TAKING SUCH A CASE BECAUSE OF SOME PREVIOUS OR CONTINUING RELATIONSHIP WITH THE PEOPLES TEMPLE, AND 2) TO DETERMINE IF HE HAD AN INTEREST IN THE CASE. IN ANSWER TO THE LATTER QUESTION, [REDACTED] SAID HE WOULD BE FREE AND AVAILABLE TO SERVE AS LEGAL ADVISER TO THE USG IN GUYANA IN RESOLVING

b6 per FBI
b7C

~~CONFIDENTIAL~~

~~CONFIDENTIAL~~

PAGE 03

GEORGE 03938 260057Z

THE LEGAL PROBLEMS OF THE JONESTOWN DISASTER.

5. [] SAID THAT THERE HAD BEEN A PAST RELATIONSHIP BETWEEN HIS FIRM AND THE PEOPLES TEMPLE INVOLVING THE STOEN CUSTODY CASE. IN THAT PROCESS, HIS BROTHER, SIR LIONEL, ACTED IN DEFENSE OF JONES, BUT HE HIMSELF HAD NOT HAD ANY DIRECT INVOLVEMENT. HE ADDED THAT HIS BROTHER A RENOWNED CRIMINAL TRIAL LAWYER WHO APPEARS IN THE GUINNESS BOOK OF RECORDS AS THE SUCCESSFUL DEFENDER OF OVER 200 MURDER CASES, HAS BEEN APPROACHED BY AT LEAST ONE OF THE AMERICANS WHO HAS BEEN CHARGED WITH MURDER SINCE THIS EPISODE AT JONESTOWN BEGAN.

b6 Per FBI
b7C

EMBASSY HAS HEARD INFORMALLY TODAY THAT AMCIT LARRY ~~W~~LAYTON, WHO HAS BEEN ^{Huyam}ARRESTED ~~AND~~ CHARGED IN CONNECTION WITH THE SHOTTING AT PORT KAITUMA ^{US} AIRSTRIP WHICH RESULTED IN THE DEATH OF CONGRESSMAN RYAN AND OTHERS OF HIS PRTY, HAS BEEN SEEKING TO ENGAGE SIR LIONEL AS DEFENSE COUNSEL. SUSPECTING THAT AMBASSADOR'S REQUEST FOR A METTING MIGHT BE RELATED TO THE JONESTOWN EPISODE

[] TOLD HIS BROTHER TO DELAY ACCEPTANCE OF THE CASE AS DEFENSE COUNSEL PENDING HIS TALK WITH THE AMBASSADOR).

5

ON THE AMBASSADOR EXPLAINED TO [] THAT, IN THE
FIRST INSTANCE, HIS TASK WOULD BE A RELATIVELY NARROW
ONE DEALING LARGELY WITH DETERMINING THE CORPORATE
RELATIONSHIP OF JIM JONES AND THE PEOPLES TEMPLE WITH
THE GOVERNMENT AND IDENTIFYING THE LOCAL ASSETS OF JIM JONES,
ET AL. HE WAS TOLD THAT IT WAS QUITE LIKELY THAT THE
OFFICE OF LEGAL ADVISOR OF THE DEPARTMENT OF STATE
WOULD BE SENDING A MEMBER OF ITS STAFF TO GEORGETOWN
TO TAKE OVERALL CHARGE OF SUCH AN INVESTIGATION AND
THE PRECISE DETAILS OF HIS ENGAGEMENT WOULD THEN BE
WORKED OUT SHOULD BOTH PARTIES BE PREPARED TO ACCEPT
THE ARRANGEMENTS.

~~CONFIDENTIAL~~

~~CONFIDENTIAL~~

PAGE 04

GEORGE 03938 260057Z

7. COMMENT: [REDACTED] IS PROBABLY AS QUALIFIED AS LEGAL ADVISER AS CAN BE OBTAINED IN GEORGETOWN AT THIS MOMENT. THE POSSIBLE INVOLVEMENT OF HIS BROTHER AS DEFENSE ATTORNEY FOR AN AMERICAN CITIZEN ACCUSED OF MURDER IN CONNECTION WITH THE SHOOTING OF CONGRESSMAN RYAN, HOWEVER, IS A POTENTIAL PROBLEM. IF THAT IS NOT AN OVERRIDING CONSIDERATION, IT IS RECOMMENDED THAT WE MAKE A DECISION VERY QUICKLY TO ENGAGE [REDACTED] AND MOVE PROMPTLY TO DRAFT THE TERMS OF REFERENCE WITHIN WHICH WE EXPECT HIM TO WORK.

BURKE

b6
b7c

UNCLASSIFIED

FBB619

Assoc. Dir.	
Dep. AD Adm.	
Dep. AD In	
Asst. Dir.:	<i>MAOR</i>
Adm. Serv.	
Crim. Inv.	<input checked="" type="checkbox"/>
Ident.	
Intell.	
Laboratory	
Legal Coun.	
Plan. & Insp.	
Rec. Mgmt.	
Tech. Servs.	
Training	
Public Affs. Off.	
Telephone Rm.	
Director's Sec'y	

PAGE 01 STATE 299104

ORIGIN ARA-15

26 Nov 78 00 17z

INFO OCT-01 SSO-00 ISO-00 DODE-00 / SCS-06 CIAE-00

INR-10 NSAE-00 PA-02 TRSE-00 CA-01 INRE-00 SY-05

H-02 SS-15 NSCE-00 CCO-00 OC-06 ICAE-00 FBIE-00

JUSE-00 AID-05 / 068 R

ALL INFORMATION CONTAINED
HEREIN IS UNCLASSIFIED
DATE 9/29/92 BY 1046 DKA

DRAFTED BY ARA:WDCALDERHEAD:JE

APPROVED BY ARA:JABUSHNELL

S/S-O:RCASTRODALE

Leo J Ryan

FEDERAL GOVERNMENT

b6 per FBI
b7C

083465 252331Z /20

O 252242Z NOV 78

REC-102

FM SECSTATE WASHDC

89-4286-412

TO AMEMBASSY GEORGETOWN IMMEDIATE

INFO CINCSOUTHCOM QUARRY HTS CANAL ZONE IMMEDIATE 2 NOV 27 1978

CINCMAC SCOTT AFB ILL IMMEDIATE

USREDCOM/RCJ2 MACDILL AFB FLA IMMEDIATE

USCINCARRED FT MCPHERSON GA IMMEDIATE

CDR 18TH AIRBORNE CORPS FT BRAGG NC IMMEDIATE

SECDEF WASHDC IMMEDIATE IMMEDIATE 2123

50 DEC 1 1978
JCS WASHDC IMMEDIATE 1721

UNCLAS STATE 299104

E.O. 11652: N/A

TAGS: AFSP, GY

SUBJECT: TASK FORCE SUPPLIES AND EQUIPMENT

1. DOD SOURCES ADVISE THE DEPARTMENT THAT SPECIAL EQUIP-
MENT HAS BEEN AIRLIFTED TO GEORGETOWN VIA U.S. MILITARY

AIRCRAFT AS FOLLOWS:

16 PORTABLE MOTOROLA RADIOS

3 FM RADIO BASE SETS

UNCLASSIFIED

UNCLASSIFIED

PAGE 02

STATE 299104

2 SINGLE SIDE BAND RADIOS

96 SLEEPING BAGS

200 BLANKETS

3153 "C" RATIONS

5 40-HP OUTBOARD MOTORS

5 POWER GENERATORS

1 1/4 T JEEP

5 POLAROID CAMERAS

3

5 FINGERPRINT KITS

200 FLASHLIGHTS

200 PONCHOS

200 CANTEENS

200 MESS KITS

THE ABOVE EQUIPMENT WAS REQUESTED IN GEORGETOWN 3785 AND 3816. THE ONLY ITEM NOT SHIPPED IS THE TWIN-ENGINE SMALL AIRCRAFT WHICH WAS REQUESTED ON A LOAN BASIS IN GEORGETOWN 3785.

2. MOST OF THE ITEMS REQUESTED IN GEORGETOWN 3882 ARE

UNCLASSIFIED

UNCLASSIFIED

PAGE 03 STATE 299104

BEING PULLED TOGETHER FROM VARIOUS DOD SOURCES AND POSI-
TIONED AT DOVER AFB. ACTUAL SHIPMENT IS DELAYED! HOW-
EVER; PENDING INDICATION FROM EMBASSY THAT THESE ITEMS
ARE STILL ESSENTIAL AND RESOLUTION OF DIFFICULT FUNDING
PROBLEM. ONLY ITEMS FROM THIS GROUP CLEARED TO GO FORWARD
TO GEORGETOWN NEXT 24 HOURS ON FIRST AVAILABLE FLIGHT ARE:

10 MANUAL TYPEWRITERS

3 REPRODUCTION/PHOTO MACHINES

9 BOXES PAPER, RIBBONS, ETC. }

3. NO PROCUREMENT OR SHIPMENT ACTION HAS BEEN TAKEN ON GEORGETOWN 3837. PARAGRAPH 6 OF THAT CABLE LISTED TWIN-ENGINE OTTER AIRCRAFT WITH EXTRA ENGINE, PROPELLER AND PARTS. PARAGRAPH 7 LISTED GDF AIRCRAFT PARTS WHICH ARE AVAILABLE FROM BELL HELICOPTER AT COST OF APPROXIMATELY DOLS 22,000. ACTUAL PROCUREMENT DELAYED BECAUSE OF LEGAL TECHNICALITIES. NOT AVAILABLE FROM BELL OR ELSEWHERE ARE THE REQUESTED TWO POWER TURBINE GENERATORS, THREE ACTURATOR ASSEMBLY AND FOUR RECEIVERS. PARAGRAPH 8 LISTED TWELVE WALKIE TALKIE SETS, 100 PORTABLE RUNWAY LIGHTS, TWO PORTABLE BEACONS, RUNWAY STABILIZATION EQUIPMENT AND EITHER ONE DEHAVILAND OR ONE C-123 PROVIDER AIRCRAFT.

4. NO PROCUREMENT OR SHIPMENT ACTION HAS BEEN TAKEN ON GEORGETOWN 3838 WHICH REQUESTED CHOLINESTERASE KIT AND ONE SMALL FREEZER.

5. THE EQUIPMENT REQUESTED IN GEORGETOWN 3790 SEEMS IN PART TO REPEAT OR EXPAND SOME OF THE EQUIPMENT NEEDS REQUESTED IN EARLIER MESSAGES BUT, IN ANY EVENT, HAS NOT BEEN SHIPPED. LISTED WERE SUCH ITEMS AS CAMERAS, SAWS, RADIO BEACON, PUMPS, WALKIE TALKIE SETS, POWER UNITS, COOK POTS, DORY BOATS, OUTBOARD ENGINES, TENTS, RADIOS AND LOAN OF ONE BELL 212 HELICOPTER.

UNCLASSIFIED

4

UNCLASSIFIED

PAGE 04 STATE 299104

6. GIVEN OUR ESTIMATE OF CURRENT SITUATION, IT IS HOPED
WE CAN AT LEAST MINIMIZE AND PERHAPS CANCEL OUTRIGHT MOST
OF REQUESTS FOR NOT YET PROCURED OR SHIPPED EQUIPMENT.
REQUEST EMBASSY REVIEW PROBLEM AND ADVISE SOONEST WHICH
ITEMS, IF ANY, STILL ESSENTIAL. CHRISTOPHER

AX0031 3300048Z

RR HQ SF

DE AX

R 250025Z NOV 78

FM ALEXANDRIA (89-102) (P)

TO DIRECTOR (89-4286) ROUTINE

SAN FRANCISCO (89-250) ROUTINE

BT

26 Nov 78 01 00z

FEDERAL BUREAU OF INVESTIGATION
COMMUNICATIONS SECTION

Assoc. Dir.	
Dep. AD Adm.	
Dep. AD Inv.	
Asst. Dir.:	
Adm. Serv.	
Crim. Inv.	
Ident.	
Intell.	
Lab.	
Legal Coun.	
Plan. & Insp.	
Rec. Mgmt.	
Tech. Servs.	
Training	
Public Affs. Off.	
Telephone Rm.	
Director's Sec'y	

ALL INFORMATION CONTAINED
HEREIN IS UNCLASSIFIED
DATE 9/24/92 BY 1048 DKA/ndk

UNCLAS
RYMUR

RE BUREAU TELEPHONE CALL TO AX, NOVEMBER 25, 1978. (u)

ON NOVEMBER 25, 1978

ARLINGTON, VA., ADVISED THAT HE WAS A COMMITTEE STAFFER FOR U.S. REP. LEO RYAN OF CALIFORNIA AND ACCOMPANIED THE CONGRESSMAN ALONG WITH THE FOLLOWING INDIVIDUALS FROM N.Y. TO GEORGETOWN, GUYANA ABOARD A PAN AM FLIGHT ON NOVEMBER 14-15, 1978: (u)

- JACKIE SPEIER - LEGISLATIVE COUNSEL TO RYAN
- BOB FLICK - NBC CREW
- DON HARRIS - NBC CREW
- BOB BROWN - NBC CREW
- STEVE SUNG - NBC CREW
- TIM REITERMAN - JOURNALIST-SAN FRANCISCO EXAMINER
- GREGG ROBINSON - PHOTOGRAPHER-SAN FRANCISCO EXAMINER
- RONALD JAVERS - JOURNALIST-SAN FRANCISCO CHRONICLE

REC-102

89-4286-413

23 NOV 27 1978

MR. [Handwritten signature]

b6
b7c

0-73 sent to Columbia, USSS,
JPR/PCM, 11-25-78.

58 DEC 1 1978

PAGE TWO AX 89-102 UNCLAS

GORDON LINDSEY - FREE LANCE WRITER

CHARLES KRAUSE - JOURNALIST-WASHINGTON POST

TIM AND GRACE STOEN - CONCERNED RELATIVES

STEVE KATSARIS - CONCERNED RELATIVE

ANTHONY KATSARIS - CONCERNED RELATIVE

CLARA BOUGUET - CONCERNED RELATIVE

HOWARD BEVERLY OLIVER - CONCERNED RELATIVE

JIM COBB - CONCERNED RELATIVE

WAYNE PIETELA - CONCERNED RELATIVE

BONNIE THIELMAN - CONCERNED RELATIVE

THOSE WHO TRAVELED ON FROM GEORGETOWN TO JONESTOWN, GUYANA ON
NOVEMBER 17, 1978 ABOARD A CHARTERED AIRCRAFT ARE AS FOLLOWS:

LEO RYAN - U.S. CONGRESSMAN

MARK LANE - ATTORNEY FOR PEOPLES TEMPLE-JONESTOWN

JACKIE SPEIER - ASSISTANT TO RYAN

RICHARD DWYER - U.S. EMBASSY, GEORGETOWN

FOUR MAN NBC CREW (LISTED ABOVE)

FIVE JOURNALISTS (LISTED ABOVE)

UNIDENTIFIED OFFICER WITH THE GUYANA INFORMATION AGENCY

PAGE THREE AX 89-102 UNCLAS

IT SHOULD BE NOTED THAT [REDACTED] DID NOT TRAVEL TO JONESTOWN.

[REDACTED] DID ASSIST THE GUYANESE AUTHORITIES TO IDENTIFY THOSE
KILLED TRAVELING IN CHARTERED AIRCRAFT. [REDACTED] HAS NO DIRECT
KNOWLEDGE OF ANY ASSASSINATION LIST PUBLISHED BY THE PEOPLES TEMPLE;
HOWEVER, UNDERSTANDS THROUGH CONTACT WITH FORMER MEMBERS AND RELA-
TIVES THAT SUCH A LIST MIGHT EXIST (u)

[REDACTED] COULD OFFER NO ADDITIONAL DIRECT INFORMATION RE
CAPTIONED MATTER. (u)

FD 302 TO FOLLOW (u)

BT

b6
b7c

~~CONFIDENTIAL~~

FBB680

Assoc. Dir.	_____
Dep. AD Adm.	_____
Dep. AD Inv.	_____
Asst. Dir.:	_____
Adm. Serv.	_____
Crim. Inv.	_____
Ident.	_____
Incl.	_____
Laboratory	_____
Legal Coun.	_____
Plan. & Insp.	_____
Rec. Mgmt.	_____
Tech. Servs.	_____
Training	_____
Public Affs. Off.	_____
Telephone Rm.	_____
Director's Sec'y	_____

PAGE 01

2Y2224Z 26 Nov 78 23 04z

ACTION ARA-QT

RECEIVED
 FEDERAL BUREAU
 OF INVESTIGATION
 COMMUNICATIONS SECTION

INFO OCT-01 SSO-00 INRE-00 SS-IT SCS-06 CA-01 L-03

H-01 INR-10 SY-05 SYE-00 FBIE-00 PA-01 JUSE-00

AID-PT TRSE-00 /063 W

-----AAAAAAAAPOPY.QO 262232Z /61

B 262000Z NOV 78

FM COMUSJTF SOUTH/TIMERHRI AIRPORT GUYANA/AHF2

TO JCS WASH DC

USCINCSO QUARRY HEIGHTS CZ

USCINCRD MACDILL AFB FL

CINCMAC SCOTT AFB ILL

CSAF WASH DC

INFO SEC DEF WASH DC

SEC STATE WASH DC

WHITE HOUSE WASH DC//SITROOM//

CSA WASH DC

DIRNSA FT GEORGE G. MEADE MD

21 AF OC MCGUIRE AFB NJ

AF MPC RANDOLPH AFB TX//MPCCM//

CDR 1ST CORP SUPPORT COMMAND FT BRAGG NC

USCINCARRED FT MCPHERSON GEORGIA

436 MAW DOVER AFB DE//SVM//

Declass per DOD let 9/16/2005
65179 DMH/ST/bpg

436 MARG DOVER AFB DE//SVM//

CDR XVIII ABN CORPS FT BRAGG NC

FBI
 ALL INFORMATION CONTAINED
 HEREIN IS UNCLASSIFIED
 DATE 9/24/92 BY 1048 DKM/DA

FEDERAL GOVERNMENT

Leo J Ryan

b6 per FBI
b7c

REC-102

89-4286-414

23 1

58 NOV 30 1978

ARRX

SCOTT AFB IL//CAT//

39 ARRW EGLIN AFB FL//CAT//

41 RWRW MCCLELLAN AFB CA//CAT//

ROOSEVELT ROADS SAN JUAN PR//SAR MISSION CONTROL//

AMEMBASSY GEORGETOWN GUYANA

~~CONFIDENTIAL~~

SITUATION REPORT NUMBER SIX AS OF WYQIPPZ NOV 78 (U)

~~CONFIDENTIAL~~

2

~~CONFIDENTIAL~~

PAGE 02

262224Z

(U) 1. ~~1.~~ SITUATION. USJTF SOUTH'S PRIMARY MISSION OF REMOVAL OF HUMAN REMAINS FROM JONESTOWN AND GUYANA COMPLETED WITH SHIPMENT OF LAST HUMAN REMAINS TO CONUS AT 260150Z NOV 78N ON MAC MISSION 1030-06M ASSIGNED FORCES INVOLVED IN THE REMOVAL OF HUMAN REMAINS HAVE BEEN RELEASED. RETROGRADE OPERATIONS COMMENCED WITH THE DEPARTURE OF MAC MISSION SQA 1594 AT 260200Z NOV 78. GOVERNMENT OF GUYANA HAS REQUESTED TRANSPORT ASSISTANCE IN ITS ROLE OF SUPPLYING PHYSICAL SECURITY TO JONESTOWN AND ITS CONTINUING INVESTIGATION DURING THE NEXT FEW WEEKS. US INVESTIGATIVE PERSONNEL MAY ALSO REQUIRE AIR TRANSPORT. COMUSJTF SOUTH/USCINCSO WILL SUPPORT THIS MISSION WITH US HELICOPTER ASSETS. ALSO, REQUIREMENT MAY

3

EXIST FOR EVACUATION OF SURVIVORS, INCLUDING THOSE NOW HOSPITALIZED. IN ANTICIPATION OF POSSIBLE TASKING FOR THIS MISSION, 8 USAF SECURITY POLICE PERSONNEL NOW AT TIMEHRI AIRPORT, WILL REMAIN IN GUYANA TO ASSIST IN PROVIDING SECURITY FOR THIS EVACUATION.

2. (U) INTELLIGENCE. NONE.

(U) 3. ~~XX~~ EVALUATION OF SIGNIFICANT FACTORS.

A. PERSONNEL STATUS

(1) USSOUTHCOM 14/25

(2) USREDCOM

(A) HQ COSCOM 4/8

0

(B) 396 MED CLEARINGHØ/Ø

(C) 5EPH GRAVE REG DET Ø/1

(D) 498TH MED CO 1/8

(E) TOTAL 5/17

(3) OTHER

~~CONFIDENTIAL~~

4

~~CONFIDENTIAL~~

PAGE 03

262224Z

(A) MAC/ARRS 4/37

(B) JCSE 3/19

(C) 114TH AVN CO 3/5

(D) 352 AVN CO 2/4

(E) TOTAL 12/65

(4L GRAND TOTAL 31/107

5

NOTE: ALL PERSONNEL LOCATED AT MAIN SUPPORT BASE AT TIMEHRI AIRPORT, GUYANAM

B. MAC MISSIONS (READ IN FIVE COLUMNS).

MISSION NO	AIRCRAFT	TAIL NO	BLOCK TIME/ETA	TAKE OFF TIME/ETD
1033-01	C-141	50258	251950Z	252140Z
SQA-1TOR	C-130	5003P	252255Z	260200Z
1030-065	C-141	50260	25233PZ	2601RUZ
1030-06	C-1RQ	5026P	2523EPZ	WYPQRUZ
10EQAPR	C-141	7PPQ0	WYPEWTZ	260525Z
1031-05	C-141	67950	260820Z	261010Z
1031-06	C-141	60137	260915Z	261WEWZ
1031-PU	C-141	406E0	261REPZ	261621Z
1031-08	C-141	59405	WYQYEPZ	261845Z
1031-09	C-141	S 50271	261850Z	262105Z
1031-10	C-141	50251	262050Z	262305Z
1031AQW	C-QRQ	50265	270050Z	270305Z
1031-13	C-141S	60155	270250Z	270605Z
1031-14	C-141	60195	270450Z	270805Z
1031-15	C-141	NONE ASS.	270650Z	2UPOPTZ
103QAQQ	CAQRQ	50258	27PUTPZ	271005Z

(U) 4. ~~CONFIDENTIAL~~ OPERATIONAL SUMMARY. FLIGHT OPERATIONS AT TIMEHRI ARE BEING PHASED DOWN. THE U-21 DEPARTED FOR THE CANAL ZONE AT 26093PZ NOV. ONE OH-58 AND FIVE UH-1H'S ARE BEING DISMANTLED. ONE HH-53 DEPARTED AT 1200Z FOR MATTHEWS RIDGE TO RETROGRADE EQUIPMENT TO MAIN OPERATING BASE; ONE HOUR WAS EXPENDED IN

~~CONFIDENTIAL~~

PAGE 04

262W24Z

PAGE FIVE RULPBFA2565 ~~C O N F I D E N T I A L~~

GROUND SEARCH OF THE JONESTOWN AREA. ALL OF THE HH-53'S WILL DEPART FOR EGLIN 2YQQPPZ NOV AND ARE OPERATIONAL READY.

FLYING HOUR/SORTIE SUMMARY FOR IN-COUNTRY FLIGHTS ONLY IS AS FOLLOWS:

ACFT	HOURS	SORTIES
U-21	19MT	22
UH-1	102.6	120
OH-51	22.9	47
HH-53	96.8	30
HC-130	29.3	9
TOTAL	271.1	228

SUMMARY OF SUPPORT FLIGHTS INTO GUYANA FOR THIS OPERATION IS AS FOLLOWS C-141 - 45, C-130 - 58, HC130 - 6, WC130 - 1M

THE ABOVE SUMMARIES DO NOT INCLUDE POSITIONING/STAGING FLIGHTS OUTSIDE OF GUYANA.

7
SMKC) COMMANDERS PLANS. THE SUPPORT BASE AT TIMEHRI AIRPOGT,

GUYANA WILL BE DISESTABLISHED AND COMUSJTF AND USJTF REDE-
PLOYED. LAST REDEPLOYMENT MISSION NOW SCHEDULED TO DEPART
TIMEHRI AIRPORT AT 271005Z NOV 78. COMUSJTF SOUTH WILL BE
DISESTABLISHED UPON ARRIVAL OF THE COMMANDER IN THE CANAL
ZONE. THE COMMANDER IS NOW SCHEDULED TO DEPART TIMEHRI
AIRPORT, GUYANA

MAC MISSION 1031-15 AT 271005Z NOV 78.

THIS IS THE LAST COMUSJTF SOUTH SITREP.

QDS 86

EOT

l

PX0003 3300216Z

OO HQ SF TP WF

DE PX

O 260216Z NOV 78

FM PHOENIX (89 271) P

TO DIRECTOR (89 4286) IMMEDIATE

SAN FRANCISCO (89 250) IMMEDIATE

TAMPA IMMEDIATE

WFO (89 570) IMMEDIATE

BT

UNCLAS

RY MUR.

76 Nov 78 02 22z

RECEIVED
FEDERAL BUREAU
OF INVESTIGATION
COMMUNICATIONS SECTION

Assoc. Dir.	_____
Dep. AD Adm.	_____
Dep. AD Inv.	_____
Asst. Dir.:	_____
Adm. Serv.	_____
Crim. Inv.	_____
Ident.	_____
Intcl.	_____
Laboratory	_____
Legal Coun.	_____
Plan. & Insp.	_____
Rec. Mgnt.	_____
Tech. Servs.	_____
Training	_____
Public Affs. Off.	_____
Telephone Rm.	_____
Director's Sec'y	_____

ALL INFORMATION CONTAINED
HEREIN IS UNCLASSIFIED
DATE 9/24/92 BY 1015 DEN/ldh

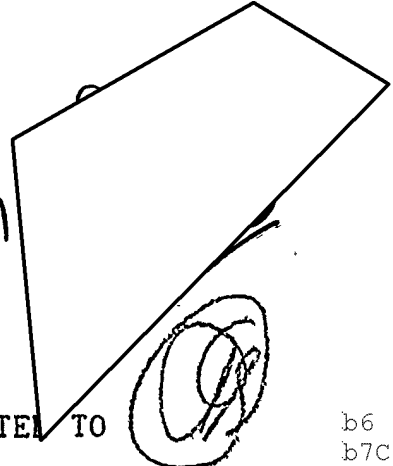

RE PXTEL TO WFO, NOVEMBER 24, 1978 AND SAN ANTONIO TEL TO PHOENIX AND RECEIVING OFFICES NOVEMBER 25, 1978. (u)

ON NOVEMBER 25, 1978, [REDACTED] PHOENIX, ARIZONA, ADVISED AMATEUR RADIO OPERATOR [REDACTED] OF WHICH HE WAS PREVIOUSLY UNSURE OF CALL SIGN, IS IN REALITY [REDACTED] ASSIGNED TO [REDACTED] CLEARWATER, FLORIDA/SAFETY HARBOR, FLORIDA. (u)

WFO DISCONTINUE EFFORTS TO IDENTIFY TRANSPOSITION OF CALL LETTERS [REDACTED] AS REQUESTED BY PHOENIX IN REFERENCED TELETYPE. (u)

BT

REC-102

89-4286-415

23 NOV 27 1978

58 DEC 1 1978

b6
b7c

Assoc. Dir.	_____
Dep. AD Adm.	_____
Dep. AD Inv.	_____
Asst. Dir.:	_____
Adm. Serv.	_____
Crim. Inv.	_____
Ident.	_____
Intell.	_____
Laboratory	_____
Legal Coun.	_____
Plan. & Insp.	_____
Rec. Mgnt.	_____
Tech. Servs.	_____
Training	_____
Public Affs. Off.	_____
Telephone Rm.	_____
Director's Sec'y	_____

PAGE PQ GEORGE 03951 2621497

26 NOV 78 22 15
RECEIVED
FEDERAL BUREAU
OF INVESTIGATION
COMMUNICATIONS SECTION

ACTION ARA-15

INFO OCT-PQ ISO-00 SCS-06 CA-01 FBIE-0P JUSE-00 L-03
H-02 CIAE-00 INR-10 NSAE-00 INRE-0P NSCE-00 SS-
SSO-0P /053 W

[Handwritten signature]

-----AAAAAAAAAAAAAPOPT EI 2621TEZ /14

O 26213PZ NOV 78
FM AMEMBASSY GEORGETOWN
TO SECSTATE WASHDC NIACT IMMEDIATE 8221

ALL INFORMATION CONTAINED
HEREIN IS UNCLASSIFIED
DATE 9/24/92 BY 1048 DCM/MLA

[Redacted box]
[Handwritten initials]

FEDERAL GOVERNMENT

b6 per FBI
b7C

UNCLAS GEORGETOWN 3951

Leo Ryan

E.O. 11652: N/A

TAGS: CDES, UREP, GY

SUBJECT: VERIFYING REMOVAL OF ALL HUMAN REMAINS FROM JONESTOWN SITE

REC-102 89-4286-416

REV: (A) STATE 299118 (B) BUSHNELL/WARD TELCON 11/26/78

23 NOV 27 1978

FOLLOWING INFORMATION IS KEYED TO PARA 2 OF REFTEL (A) C

58 DEC 11 1978

2. ACTIONS TAKEN BY U.S. MILITARY:

[Handwritten signature]

A) UPON ARRIVAL AT [REDACTED], THE JOINT TASK FORCE (JTF) MET WITH NATIONAL POLICE OFFICIALS AND THE COMMANDANT OF THE GDF BATTALION WHO HAD ARRIVED AT THE JONESTOWN SITE SUNDAY NIGHT. THESE OFFICIALS TOOK THE JTF THROUGH THE AREA, EXPLAINED THAT THEY HAD ALREADY SEARCHED EVERY RESIDENCE AND BUILDING, AND POINTED OUT THE LOCATIONS OF THOSE BODIES NOT AMONG THE MAIN GROUP AROUND THE CENTRAL PAVILION. THESE OFFICIALS ALSO PROVIDED THE JTF WITH THE FIRST ESTIMATED COUNT.

B) THE JTF THEN MADE THEIR OWN SEARCH, ENTERING EVERY BUILDING AND COVERING EVERY INCH OF TERRAIN.

C) THE JTF REMOVED THE ISOLATED REMAINS FIRST, BEFORE ADDRESSING THE TASK OF REMOVING THOSE PILED AROUND THE PAVILION.

UNCLASSIFIED

PAGE 02

GEORGE PEOTQ 262149Z

D) ALTHOUGH THE PRESENCE OF UNDISCOVERED BODIES WOULD HAVE BEEN OBVIOUS FROM THE STRONG ODOR ALONE, THE JTF MADE ANOTHER COMPLETE SWEEP OF ALL BUILDINGS AND THE AREA AFTER ALL BODIES HAD BEEN BAGGED/ COL. WILLIAM GORDON, USA, ADVISED THE AMBASSADOR SATURDAY NIGHT THAT A CHECK PRIOR TO FINAL DEPARTURE OF THE JTF DISCLOSED NO REMAINS OR EVIDENCE OF REMAINS OTHER THAN THE FIVE GRAVESITES PREVIOUSLY REPORTED.

3. ACTIONS TAKEN BY EMBASSY OFFICERS:

AL CONSULAR OFFICER RICHARD MARTIN WAS AT THE SITE THURSDAY AND FRIDAY. DURING THESE TWO VISITS HE COMBED THE AREA LOOKING FOR ANY IDENTIFIABLE PERSONAL EFFECTS WITH ANY VALUE. HE ENTERED ALL OF THE ADMIN. BUILDINGS IN WHICH BODIES HAD INITIALLY BEEN DISCOVERED, MOST OF THE OTHER RESIDENCES AND ENCOUNTERED NO HUMAN REMAINS.

B) CONSULAR OFFICER JAMES WARD WAS AT THE SITE ON SATURDAY, NOVEMBER 25, TO MAKE AN ANALYSIS OF THE EXISTENCE OF ANY TANGIBLE PERSONAL ESTATES AND THE FEASIBILITY OF SECURING THEM. DURING THIS EXERCISE HE ENTERED ALL BUILDINGS WHERE BODIES HAD BEEN DISCOVERED, ALL ADMINISTRATIVE STRUCTURES, INCLUDING THE PAVILION, ALL LARGE DORMITORIES AND A NUMBER OF THE SMALL RESIDENCES. HE DISCOVERED NO HUMAN REMAINS. HE ALSO OBSERVED THE LOADING OF THE LAST REMAINS OF THE TRANSPORT HELICOPTER.

BUR KE

PAGE 01 STATE 299148

ORIGIN ARA-15

INFO OCT-01 ISO-00 SSO-00 SCS-06 CA-01 SVC-00

FBIE-00 SS-15 CIAE-00 INR-10 NSAE-00 NSCE-00

ICAE-00 INRE-00 PA-01 TRSE-00 SY-05 SYE-00 USSS-

H-01 JUSE-00 /05 I R

26 Nov 78 20 30
RECEIVED
FEDERAL BUREAU
OF INVESTIGATION
COMMUNICATIONS SECTION

Asst. Dir.:	
Adm. Serv.	
Crim. Inv.	
Ident.	
Intell.	
Laboratory	
Legal Coun.	
Plan. & Insp.	
Rec. Mgnt.	
Tech. Servs.	
Training	
Public Affs. Off.	
Telephone Rm.	
Director's Sec'y	

FBI
ALL INFORMATION CONTAINED
HEREIN IS UNCLASSIFIED
DATE 9/24/92 BY 1043 DKM/mam

Leo Ryan

DRAFTED BY ARA: AHEWITT:JE

APPROVED BY ARA: JABUSHNELL

S/S-O: TREYNDERS

-----AAAAAAAAAPOPWIQ 261926Z /14

b6 per FBI
b7C

O 261845Z NOV 78

FM SECSTATE WASHDC

FEDERAL GOVERNMENT

TO AMEMBASSY GEORGETOWN IMMEDIATE

INFO CINCSOUTHCOM QUARRY HTS CZ IMMEDIATE

CINCMAC SCOTT AFB ILL IMMEDIATE REC-102

89-4286-417

US REDCOM/RCJ2 MACDILL AFB FLA IMMEDIATE

USCINCARRED FT MCPHERSON GA IMMEDIATE

23 NOV 27 1978

CDR 18TH AIRBORNE CORPS FT BRAGG NC IMMEDIATE

SECDEF WASHDC IMMEDIATE IMMEDIATE 2129

JCS WASHDC IMMEDIATE 1728

RTD

58 DEC 1 1978

E.O. 11759 N/A

TAGS: CASC, GY

SUBJECT: PRESS INQUIRIES ON PEOPLE'S TEMPLE

1. PRESS HAS INQUIRED WHETHER AMBASSADOR BURKE EVER MET WITH REVEREND JIM JONES OFFICIALLY OR SOCIALLY. CAN THE EMBASSY SUPPLY THIS INFORMATION? WE ARE AWARE FROM MCCOY OF A MEETING BETWEEN AMBASSADOR BURKE AND MRS. JONES BUT WOULD APPRECIATE THE DATE OF THAT MEETING.

LIMITED OFFICIAL USE

PAGE 0W

STATE 299148

2. DID THE EMBASSY EVER RECEIVE A COPY OF THE SO-CALLED
BLAKEY AFFIDAVIT EXECUTED IN CALIFORNIA JUNE 15, 1978?
THE DEPARTMENT (SCS) WAS SENT A COPY, BUT ARA FILES DO
NOT CONTAIN A COPY. MCCOY SAYS NO COPY WAS RECEIVED BY
THE EMBASSY PRIOR TO HIS DEPARTURE ON AUGUST 5, BUT IT
MAY HAVE BEEN RECEIVED THEREAFTER. IF THE AFFIDAVIT WAS
RECEIVED BY THE EMBASSY, WAS IT DISCUSSED WITH THE GOG?
CHRISTOPHER

~~CONFIDENTIAL~~

FBB673

Assoc. Dir.	_____
Dep. AD Adm.	_____
Dep. AD Inv.	_____
Asst. Dir.:	_____
Adm. Serv.	_____
Crim. Inv.	_____
Ident.	_____
Intell.	_____
Laboratory	_____
Legal Coun.	_____
Plan. & Insp.	_____
Rec. Mgnt.	_____
Tech. Servs.	_____
Training	_____
Public Affs. Off.	_____
Telephone Rm.	_____
Director's Sec'y	_____

PAGE 01

STATE

26 Nov 78 21 08z
299154

ORIGIN L-03

FEDERAL BUREAU OF INVESTIGATION
COMMUNICATIONS SECTION

INFO OCT-01 ARA-11 ISO-00 JUSE-00 SS-15 DODE-00 FBIE-
 CA-PQ TRSE-00 NSCE-00 AID-05 SSO-00 SCS-06
 CIAE-00 INR-10 NSAE-00 INRE-00 H-01 /053 R

DRAFTED BY L/ARA:MKOZAK:SJP
 APPROVED BY ARA:JBUSHNELL
 JUSTICE:RKEUCH
 S/S-O:TREYNDERS

FBI
 ALL INFORMATION CONTAINED
 HEREIN IS UNCLASSIFIED
 DATE 9/21/92 BY 1048 DCM/ndm
 FEDERAL GOVERNMENT

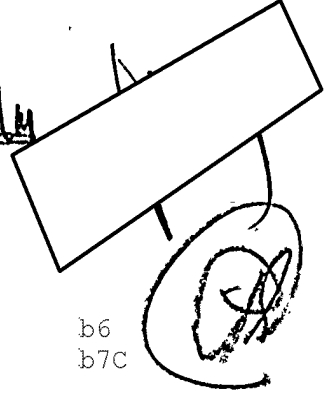

b6
b7c

-----AAAAAPOPRPE 3262040Z /14

O 262021Z NOV 78 ZFF4
 FM SECSTATE WASHDC
 TO AMEMBASSY GEORGETOWN NIACT IMMEDIATE

REC-102

89-4286-418

~~CONFIDENTIAL~~ STATE 299154

23 NOV 27 1978

E.O. 11652: GDS

TAGS: GY, CASC, OREP (RYAN, LEO)

Declass per State let 2/16/05
UC65179DMH/ST/bpg

SUBJECT: HELICOPTER SUPPORT

58 NOV 30 1978

REFS: GEORGETOWN 3940; KOZAKXWARD TELECON 11/26/78

1. IN CONSIDERING REQUEST FOR HELICOPTER SUPPORT, WE
HAVE BEEN REVIEWING POSSIBLE AUTHORITY FOR FUNDING.

2. ONE POTENTIAL SOURCE THUS FAR IDENTIFIED WOULD BE FBI
REIMBURSEMENT TO DOD UNDER ECONOMY ACT OF 1932. THIS
STATUTE WOULD AUTHORIZE EXPENDITURE OF FUNDS FOR
LEGITIMATE U.S. LAW ENFORCEMENT PURPOSES. JUSTICE HAS
INTERPRETED AS REQUIRING THAT U.S. LAW ENFORCEMENT
PERSONNEL (I.E. FBI) BE PRIMARY RECIPIENTS OF SUPPORT
AND THEREFORE THEY WOULD HAVE TO BE PRESENT ON ALL
HELICOPTER MISSIONS. THEY PRESUMABLY COULD ALSO TRANSPORT
GOG PERSONNEL COOPERATING WITH THEM IN THEIR LAW ENFORCE-

~~CONFIDENTIAL~~

~~CONFIDENTIAL~~

PAGE 02 STATE 299154

MENT FUNCTIONX

3. AT THIS POINT, WE CANNOT DEFINITELY EXCLUDE OTHER POSSIBLE SOURCES OF FUNDING, NOR CAN WE GUARANTEE THAT FBI OPTION WILL PROVE FEASIBLE. AT THE MOMENT, HOWEVER, IT APPEARS TO HAVE THE GREATEST POTENTIAL FOR SUCCESSX

4. PER REF TELECON, WE BELIEVE THAT IT WOULD BE USEFUL IN YOUR CONTACTS WITH GOG TO NOTE THAT AUTHORIZATION FOR U.S. INVESTIGATIVE EXPERTS TO ENTER GUYANA COULD FACILITATE OUR EFFORTS TO PROVIDE FAVORABLE RESPONSE TO GOG REQUEST FOR HELICOPTER SUPPORT IN LIGHT OF FUNDING SITUATION DESCRIBED ABOVE.

CHRISTOPHER

3

Assoc. Dir.	
Dep. AD Adm.	
Dep. AD Inv.	
Asst. Dir.:	
Adm. Serv.	
Crim. Inv.	
Ident.	
Int'l.	
Laboratory	
Legal Coun.	
Plan. & Insp.	
Rec. Mgmt.	
Tech. Servs.	
Training	
Public Affs. Off.	
Telephone Rm.	
Director's Sec'y	

VV FB115

00 RUEHFB

DE RUESON #3949 3302050

ZNR UUUUU ZZH

O R 262040Z NOV 78

FM AMEMBASSY GEORGETOWN

26 Nov 78 21 09Z

COMMUNICATIONS SECTION

ALL INFORMATION CONTAINED
HEREIN IS UNCLASSIFIED
DATE 9/21/92 BY 1046 OKM/MLM

TO RUEHSE/USSS WASHDC/ID-FIB NIACT IMMEDIATE

INFO RUEHFB/DIRECTOR FBI

RUEHC/SECSTATE WASHDC 8219

RUEBWJA/INS NEW YORK

BT

UNCLAS GEORGETOWN 3949

Leo Ryan

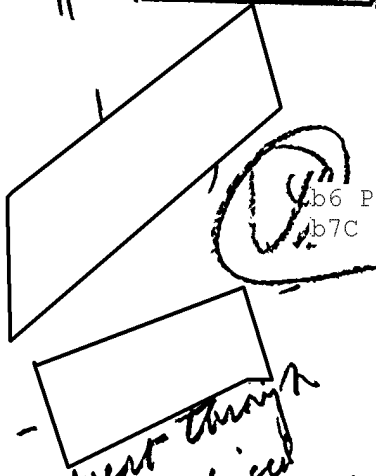

b6 Per FBI
b7C

11/27/78

telcal to NYS... DE Pina went through to ha - la advice by teletype 11/27/78

FEDERAL GOVERNMENT

E.O. 11652: N/A

TAGS: CASC (PEOPLE'S TEMPLE)

SUBJECT: DEPARTURE FROM GUYANA OF MIGUEL DE PINA, PEOPLE'S TEMPLE MEMBER

REC-102
DE-51

89-4286 - 419

23 NOV 27 1978

1. MIGUEL DE PINA DEPARTED TIMEHRI AIRPORT AT 1 PM LOCAL TIME ABOARD PAN AM FLIGHT 228. MR. DE PINA WAS AMONG THE GROUP OF PEOPLE'S TEMPLE MEMBERS WHO WERE AT THE LAMAHA GARDENS HEADQUARTERS AT THE TIME OF THE MASS SUICIDE/MURDER AT JONESTOWN. MR. DE PINA IS BEING ALLOWED TO LEAVE GUYANA BY LOCAL AUTHORITIES BECAUSE HE IS IN FAILING HEALTH AND BECAUSE THEY ARE APPARENTLY SATISFIED THAT HE HAD NOTHING TO OFFER THAT WOULD ASSIST IN THEIR INVESTIGATION INTO THE DEATHS OF SHARON AND HER CHILDREN AT THE LAMAHA GARDENS HOUSE.

58 NOV 30 1978

0-73 sent to New York, San Francisco, RER/DCM, 11/26/78.

2. NO OTHER PEOPLE'S TEMPLE MEMBERS IN GUAYANA ON SATURDAY
18 NOVEMBER 1978 HAVE BEEN CLEARED TO LEAVE GUYANA BY LOCAL
AUTHORITIES.

3. MR. DE PINA'S ETA IN NEW YORK ROUGHLY 6PM EST.

4. FOR INS NEW YORK: PLEASE ADVISE AIRPORT OPERATIONS THAT
MIGUEL DE PINA WILL BE ARRIVING WITHOUT A PASSPORT TODAY, 26
NOVEMBER 1978 ABOARD PAN AM FLIGHT 228 FROM GEORGETOWN, GUYANA.
HE IS THE BEARER OF A VALID US PASSPORT, NO. G1850216 ISSUED
SAN FRANCISCO, CA ON 7/13/76, EXPIRES 7/12/81. THE PASSPORT
SHOWS THAT MIGUEL ~~DE~~ PINA WAS BORN SEPTEMBER 29, 1894
AT CAPE VERDE. PHYSICAL DESCRIPTION GIVEN AS 5'8", GRAY HAIR,
Portugal BROWN EYES. MR. DE PINA DOES NOT HAVE HIS PASSPORT IN HIS
POSSESSION BECAUSE IT WAS INCLUDED IN A GROUP OF SOME 800
PASSPORTS SEIZED BY THE GUYANESE AUTHORITIES AT JONESTOWN FOR
USE IN THEIR INVESTIGATION OF THE MASS SUICIDE/MURDER.

BURKE

BT

#3949

2

Assoc. Dir.	
Dep. AD Adm.	
Dep. AD Inv.	
Asst. Dir.:	
Adm. Serv.	
Crim. Inv.	
Ident.	
Intell.	
Laboratory	
Legal Coun.	
Plan. & Insp.	
Rec. Mgmt.	
Tech. Servs.	
Training	
Public Affs. Off.	
Telephone Rm.	
Director's Sec'y	

PAGE 01
ACTION SCS-06

GEORGE 039327 NOV 78 07 57Z

FEDERAL BUREAU OF INVESTIGATION
COMMUNICATIONS SECTION

INFO OCT-01 ARA-15 ISO-00 CA-01 H-02 L-03 JUSE-00
FBIE-00 NSC-05 SS-15 /048 W

-----AAAAAAAAPYQWQ 270138Z /64

[Handwritten initials]

R 250405Z NOV 78
FM AMEMBASSY GEORGETOWN
TO SECSTATE WASHDC 8200

[Handwritten: FBI]
ALL INFORMATION CONTAINED
HEREIN IS UNCLASSIFIED
DATE 9/24/92 BY 1046 DCM/MDA

FEDERAL GOVERNMENT

UNCLAS GEORGETOWN 3932

[Handwritten: Leo Ryan]

b6 per FBI
b7C

E.O. 11652: N/A

TAGS: CARR CASC LAYTON, LAWRENCE JOHN

SUBJECT: W/W -ARRESTS: LAWRENCE JOHN ~~LAYTON~~ (AKA ~~LARRY~~ LAYTON)

REF: GEORGETOWN 3885

DE-51

89-4286-420

ARREST REPORT UPDATE

REC-102

23 NOV 27 1978

LAYTON, LAWRENCE JOHN

[Handwritten: Ryan, Ca]

[Handwritten: 6]

3. POB GREENBELT, MARYLAND

58 NOV 30 1978

4. PPT #UNKNOWN; ISSUED SAN FRANCISCO CA

[REDACTED]
5. VISTA MONT AVENUE (HOUSE NUMBER UNKNOWN) BERKELEY CA

6. 18 NOVEMBER 1978

7. ACCORDING TO SUBJECT, "CONFUSED"

8. 5 COUNTS MURDER, 3 COUNTS ATTEMPTED MURDER

9. CAMP STREET PRISON, GEORGETOWN

12M LIFE IMPRISONMENT/EXECUTION BY HANGING. NOTE: PER PRISON
DIRECTOR FRANCE, IT IS POSSIBLE TO OBTAIN RELEASE FOR GOOD

UNCLASSIFIED

UNCLASSIFIED

PAGE 02

GEORGE 03932 260313Z

BEHAVIOR AFTER 5 YEARS SERVED ON LIFE SENTENCE. ALSO PER
MR FRANCE, THE DEATH PENALTY HAS NOT BEEN EXERCISED SINCE
1970, ALTHOUGH ITS EXERCISE IS POSSIBLE UNDER STATUTE~~X~~

13. NO

14. YES: LAYTON FAMILY

b6 Per Dept. of Sta

17M 24 NOVEMBER 1978; VISITED BY CONFFS ELLICE AND ENGLISH

18. NONE YET

19. NONE ALLEGED

A22. NO

24. DEPARTMENT SHOULD NOTIFY LAYTON FAMILY. ADDRESS GIVEN
IN NO 15 ABOVE.

BURKE

UNCLASSIFIED

FBB 694

PAGE 01

GEORGE 03942 27 NOV 78 220331

ACTION SCS-06

RECEIVED
FEDERAL BUREAU
OF INVESTIGATION
COMMUNICATIONS SECTION

Assoc. Dir.	_____
Dep. AD Adm.	_____
Dep. AD Inv.	_____
Asst. Dir.:	_____
Adm. Serv.	AD
Crim. Inv.	AD
Ident.	AD
Intell.	AD
Laboratory	_____
Legal Coun.	_____
Plan. & Insp.	_____
Rec. Mgnt.	_____
Tech. Servs.	_____
Training	_____
Public Affs. Off.	_____
Telephone Rm.	_____
Director's Sec'y	_____

INFO OCT-01 ARA-QT ISO-00 CA-01 L-03 FBIE-00 JUSE-00

H-02 SS-15 NSC-05 /048 W

-----AAPIIIQP 270321Z /12

R 260335Z NOV 78

FM AMEMBASSY GEORGETOWN

TO SECSTATE WASHDC 8213

ALL INFORMATION CONTAINED
HEREIN IS UNCLASSIFIED
DATE 9/20/92 BY 1048 DKL/udh

Gray

R Y... S...

UNCLAS GEORGETOWN 3942

FEDERAL GOVERNMENT

Leo Ryan

E.O. 11652: N/A

TAGS: CARR (BEIKMAN, CHARLES EDWARD)

SUBJECT: W/W ARRESTS: CHARLES EDWARD BEIKMAN

REF: GEORGETOWN 3821

REC-102

89-4286-421

FOLLOWIN AMERICAN ARRESTED:

23 NOV 27 1978

1. BEIKMAN, CHARLES EDWARD

58 DEC 4 1978

RECEIVED

2. M

3. AUGUST 13, 1935 INDIANAPOLIS INDIANA

4.

5. HAS BEEN IN GUYANA FOR ALMOST FIVE YEARS. ONLY LIVED
IN CALPELLA (PHONETIC), CA. MR BEIKMAN CANNOT READ OR WRITE.

6. FORMALLY CHARGED ON NOV 25, 1978, ALTHOUGH HELD SINCE
THURSDAY AFTERNOON FOR QUESTIONING.

7M NORMAL

8. MURDER (4 COUNTS) ATTEMPTED MURDER (1 COUNT)

UFCLASSIFIED

2

UNCLASSIFIED

PAGE 02

GEORGE 03942 261122Z

9. GEORGETOWN, GUYANA

10. PRETRIAL

11. DEC 14, 19UI

12. LIFE/LIFE. ALTHOUGH EXECUTION BY HANGING IS POSSIBLE,
PRISON OFFICIALS HAVE ADVISED THAT SINCE 1970 EXECUTION IS
NOT RECOMMENDED EXCEPT IN CASES INVOLVING THE MURDER OF A
POLICE OR PRISON OFFICIAL.

14. YES- TO FAMILY FRIENDS AND CONGRESSMEN

b6 per DEPT. OF ST

16. CONSOFF ADVISED BY POLICE OFFICIALS PRIOR TO HIS ARREST THAT HE WOULD PROBABLY BE CHARGED. NOTIFIED OF HIS FORMAL CHARGING ALMOST AS SOON AS IT WAS DONE.

17. CONSOFF SAW SUBJECT PRIOR TO HIS ARREST, BEFORE HE WAS NAMED BY POLICE AS CHIEF SUSPECT. PERSONAL VISIT MADE FOUR HOURS AFTER ARRAIGNMENT.

18. NA

19. NO MISTREATMENT ALLEGD

20. NONE

UNCLASSIFIED

UNCLASSIFIED

PAGE 03

GEORGE 03942 261022Z

21. NO PLEA ENTERED YET

22. NO

23. BEIKMAN IS ACCUSED OF MURDERING SHARON AMOS AND HER THREE CHILDREN, AND ATTEMPTING TO MURDER STEPHAIE JONES, ALL MEMBERS OF THE PEOPLE'S TEMPLE WHO WERE IN GEORGETOWN AT THE TIME OF THE MASS SUICIDE IN JONESTOWN, GUYANA.

24. ADVISORY OPINION. BEIKMAN SAID DEPARTMENT COULD NOTIFY NEXT OF KIN OF HIS ARREST, BUT DID NOT ACTUALLY SPECIFY THAT HE WISHED DEPARTMENT TO DO SO. HE INDICATED THAT HE DID NOT CARE ONE WAY OR THE OTHER. DEPARTMENT'S OPINION WOULD BE APPRECIATED. FOR DEPARTMENT'S INFO: SON, THOMAS BEIKMAN, IS HERE IN GEORGETOWN AND IS AWARE OF HIS FATHER'S ARREST.

BURKE

b6 per DEPT. OF STATE

5

NNNNN* FBA126

OO RUEHFB

DE RUEHC #0001 3310107

ZNY CCCCC ZZH

O 270050Z NOV 78

FM SECSTATE WASHDC

TO RUEKJCS/ JCS WASHDC IMMEDIATE 1730

INFO RUESON/AMEMBASSY GEORGETOWN IMMEDIATE 3896

RULPALJ/USCINCSO QUARRY HEIGHTS CZ

RUCJAAA/USCINCRD MACDILE AF FL

RUCIYAA/CINCMAC SCOTT AFB IL

RUEAFB/FBI WASHINGTON DC

RUEAUSA/DEPT OF HEALTH EDUCATION AND WELFARE WASHDC

RUEBWJA/DEPT OF JUSTICE WASHDC

RUEOLIA/2IAF OC MCGUIRE AFB NJ

RUESON/COMUSJTG GY

RUCLSLA/437MAW CHARLESTON AFB SC

RUEADWD/CSA WASHDC

RUEAHQA/HQ USAF WASHDC

RUENAAA/CNO WASHDC

RUEACMC/CMC WASHINGTON DC

RUWTBGR/ARRS SCOTT AFB IL//CC//

RUCLBMA/39ARRW EGLIN AFB FL

RUEHSE/SECRET SERVICE

Declass per State let 2/16/2005
UC65179DMH/ST/bpg

BT

~~CONFIDENTIAL~~ STATE 300001

58 NOV 30 1978
E.O. 11652: GDS

27 Nov 78 01 27z
COMMUNICATIONS SECTION

ALL INFORMATION CONTAINED
HEREIN IS UNCLASSIFIED
DATE 9/29/92 BY 1046 DEM/whu

Leo Ryan

Assoc. Dir.	
Dep. AD Adm.	
Dep. AD Inv.	
Asst. Dir.:	
Adm. Serv.	
Crim. Inv.	
Ident.	
Insp.	
Intell.	
Lab.	
Legal Coun.	
Plan. & Insp.	
Rec. Mgmt.	
Tech. Serv.	
Training	
Public Aff. Off.	
Telephone Rm.	
Director's Sec'y	

b6 per FBI
b7c

FEDERAL GOVERNMENT

REC-102

89-4286-422

23 NOV 27 1978

Handwritten signature

TAGS

SUBJECT: DOD ASSETS IN GUYANA

REFERENCE: JCS 262102Z NOVEMBER 1978

1. WE ARE NOT CLEAR ON WHAT BASIS YOU ASSUME SURVIVORS WILL NOT BE GIVEN PERMISSION TO LEAVE GUYANA FOR 72-HOURS.

(REFTEL). EMBASSY REPORTS SOME SURVIVORS MAY BE AUTHORIZED TO DEPART AS EARLY AS MONDAY, NOVEMBER 27TH. SOMB WILL APPARENTLY NOT BE RELEASED UNTIL EARLY DECEMBER. SOME MAY BE CHARGED WITH CRIMES.

2. GIVEN THE UNCERTAINTY OF DEPARTURE TIMING AND NUMBERS, STATE CONCURS WITH RE-DEPLOYMENT ALCE AT THIS TIME.

HOWEVER, REQUEST YOU MAINTAIN CONTINGENCY PLANNING FOR PICK-UP OF SURVIVORS ON NOT MORE THAN 24-HOURS NOTICE, SUCH NOTICE TO BE GIVEN ANY TIME AFTER 0600 EST NOVEMBER 27TH.

3. OUR UNDERSTANDING IS THAT THE RE-DEPLOYMENT OF H-53'S WILL NOT OCCUR UNTIL HUEYS WITH EXTENDED RANGE FUEL TANKS ARE OPERATING TO SUPPORT EMBASSY. VANCE

BT

#0001

2

NNNNVV FBA123

OO RUEHFB

DE RUEKJCS #2769 3310048

ZNY CCCCC

O 270043Z NOV 78

27 NOV 78 01 05z

FEDERAL BUREAU OF INVESTIGATION COMMUNICATIONS SECTION

FM JCS WASHINGTON DC//J3//

TO PULPALJ/USCINCSO QUARRY HEIGHTS

RUCIMAA/CINCMAC SCOTT AFB IL

RUCJAAA/USCINCRD MACDILL AFB FL

INFO ZEN/SECDEF WASHINGTON DC

RUSNAAA/USCINCEUR VAIHINGEN GE

RUHQHQA/CINCPAC HONOLULU HI

RUWRNLB/CINCAD PETERSON AFB CO

RUCIPBA/USCINCAFRED LANGLEY AFB VA

RUEHC/SECSTATE WASHINGTON DC

RUEADWW/WHITE HOUSE WASHINGTON DC//SITROOM//

RUWTEKA/CINCSAC OFFUTT AFB NE REG-102

RUETIAA/DIRNSA FT GEORGE G MEADE MD

RUESON/AMEMB GEORGETOWN GY

RUEBHBA/2IAF OC MCGUIRE AFB NJ//CAT//

RUCLSLA/437MAW CHARLESTON AFB SC//CC//

RUCLBMA/39ARRW EGLIN AFB FL

RUESON/COMUSJTF GY

RUCBSAA/CINCLANT NORFOLK VA

58 NOV 30 1978

Assoc. Dir.	_____
Dep. AD Adm.	_____
Dep. AD Inv.	_____
Asst. Dir.:	_____
Adm. Serv.	_____
Crim. Inv.	_____
Ident.	_____
Intell.	_____
Laboratory	_____
Legal Coun.	_____
Plan. & Insp.	_____
Rec. Mgmt.	_____
Tech. Servs.	_____
Training	_____
Public Affs. Off.	_____
Telephone Rm.	_____
Director's Sec'y	_____

ALL INFORMATION CONTAINED HEREIN IS UNCLASSIFIED DATE 9/24/92 BY 1049 DMH/ubm

FEDERAL GOVERNMENT

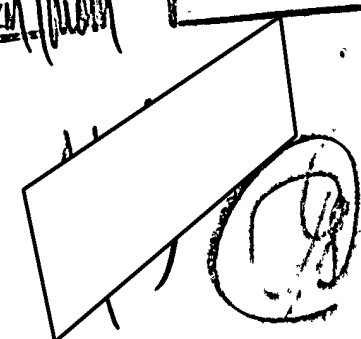

b6 per FBI b7c

Leo Ryan

89-4286-423

23 NOV 27 1978

Declassified per DOD letter 7/21/2005 65179DMH/ST/bpg

PAGE 2 RUEKJCS 2769 ~~CONFIDENTIAL~~

RUWIMAB/AFMPC RANDOLPH AFB TX//MPCCM//

RUEBEJA/436 ABG DOVER AFB DE//SVM//

RUEBEJA/436MAW DOVER AFB DE

RUCLHTD/USCINCARRED FT MCPHERSON GA

RUWTBGR/ARRS SCOTT AFB IL//CC//

RUEADWD/CSA WASHINGTON DC

RUENAAA/CNO WASHINGTON DC

RUEAHQA/CSAF WASHINGTON DC

RUEACMC/CMC WASHINGTON DC

RUEBJGA/COMDT COGARD WASHINGTON DC

RUEHFB/FBI WASHINGTON DC//DIR//

BT

~~CONFIDENTIAL~~ 4542

SUBJ: JCS SITREP 007/262400Z NOV 78 (U)

(U) 1. ~~TOP SECRET~~ SITUATION:

A. 912 BODIES HAVE BEEN AIRLIFTED TO DOVER AFB DE. A THOROUGH SEARCH OF JONESTOWN WAS CONDUCTED TO ASSURE ALL BODIES WERE FOUND/REMOVED PRIOR TO DEPARTURE OF MILITARY PERSONNEL ON 25 NOV. MEDICAL RECORDS FROM JONESTOWN ARE EN ROUTE TO DOVER,

2

MAC 1031-08.

B. COMUSJTF RETROGRADE TO GEORGETOWN COMPLETED. REDEPLOYMENT OPERATIONS TO CONUS UNDERWAY. 4-UH1H HELICOPTERS CLOSED FT BENNING 262200Z NOV 78.

C. GOVERNMENT OF GUYANA (GOG) STILL HAS NOT INDICATED WHEN REMAINING CULT SURVIVORS WILL BE RELEASED. STATE DEPARTMENT INDICATES MANY MAY NOT BE RELEASED UNTIL SOMETIME IN DECEMBER.

D. GOG REQUEST FOR US HELICOPTER SUPPORT FOR 30 DAYS (STATE SITREP NO. 21, 261846Z NOV 78) IS UNDER REVIEW.

(U)

2. ~~(S)~~ FRIENDLY OPERATIONS:

A. JCS APPROVED (WIN 196, 262121Z NOV 78) USCINCSO CONPLAN (WIN 193, 262003Z NOV 78). TWU (2) UH-1 HELICOPTERS WILL BE PROVIDED BY USCINCSO TO CONTINUE SUPPORT AMEMB GUYANA. HH 53 HELICOPTERS SHOULD NOT DEPART GEORGETOWN ON 27 NOV UNTIL CINCSO HELICOPTERS ARE OPERATIONAL.

B. TOTAL MILITARY IN GUYANA AS OF 262300Z NOV 78 IS 128.

C. STRATEGIC/TACTICAL AIRLIFT SUMMARY AS OF 262300Z NOV 78

C-141

C-130

- GEORGETOWN DEPLOYMENT

SCHEDULED

24

7

COMPLETED	24	7
REMAINING	0	0
EN ROUTE	0	0
- MOVEMENT OF REMAINS		
SCHEDULED	9	0
COMPLETED	9	-
REMAINING	0	-
EN ROUTE	0	-
- REDEPLOYMENT		
SCHEDULED	15	1
COMPLETED	6	1
REMAINING	7	0
EN ROUTE	2	0

- ADDITIONAL MISSIONS WILL BE SCHEDULED AS REQUIRED.

3. (U) GENERAL INFORMATION. JCS EXTENDED SUSPENSE FOR SUBMISSION OF COST ESTIMATES UNTIL 28 NOV 78.

GDS-84

BT

#2769

4

UNCLASSIFIED

FBB685

Assoc. Dir.	
Dep. AD Adm.	
Dep. AD Inv.	
Asst. Dir.:	
Adm. Serv.	
Crim. Inv.	
Ident.	
Insp.	
Intell.	
Lab.	
Legal Coun.	
Plan. & Insp.	
Rec. Mgmt.	
Tech. Servs.	
Training	
Public Affs. Off.	
Telephone Rm.	
Director's Sec'y	

PAGE 01

STATE 300000

27 Nov 78 0130z

ORIGIN SCS-06

COMMUNICATIONS SECTION

INFO OCT-00 ARA-15 ISO-00 CA-01 FBIE-00 CIAE-00 INR-

NSAE-00 JUSE-0P DODE-00 SS-15 SSO-00 INRE-00 L-03

H-02 SY-05 PA-02 TRSE-00 ICAE-00 /060 R

DRAFTED BY CA/VO: SKFISCHEL/SD

APPROVED BY ARA: J BUSHNELL

CA/SCS:RDAVIS

SXS-0 : RCASTRODALE

FEDERAL GOVERNMENT

ALL INFORMATION CONTAINED

HEREIN IS UNCLASSIFIED

DATE 9/24/02 BY 1096 DKM/ADM

b6 per FBI
b7C

ICC - Stuart
12 M 11/26/78

-----AAAAAAAPOQPOP 270059Z /64

O 270032Z NOV 78

FM SECSTATE WASHDC

TO AMEMBASSY GEORGETOWN IMMEDIATE

Leo Ryan

UNCLAS STATE 300000

REC-102

89-4286-424

NOV 27 1978

E.O. 11652: N/A

TAGS: CASC

SUBJECT: PEOPLE'S TEMPLE MEMBERS AND VISITORS; NEW NAMES

REPORTED IN GUYANA
58 NOV 30 1978



UNCLASSIFIED

b6 Per Dept. of State

2

UNCLASSIFIED

PAGE 02

STATE 300000

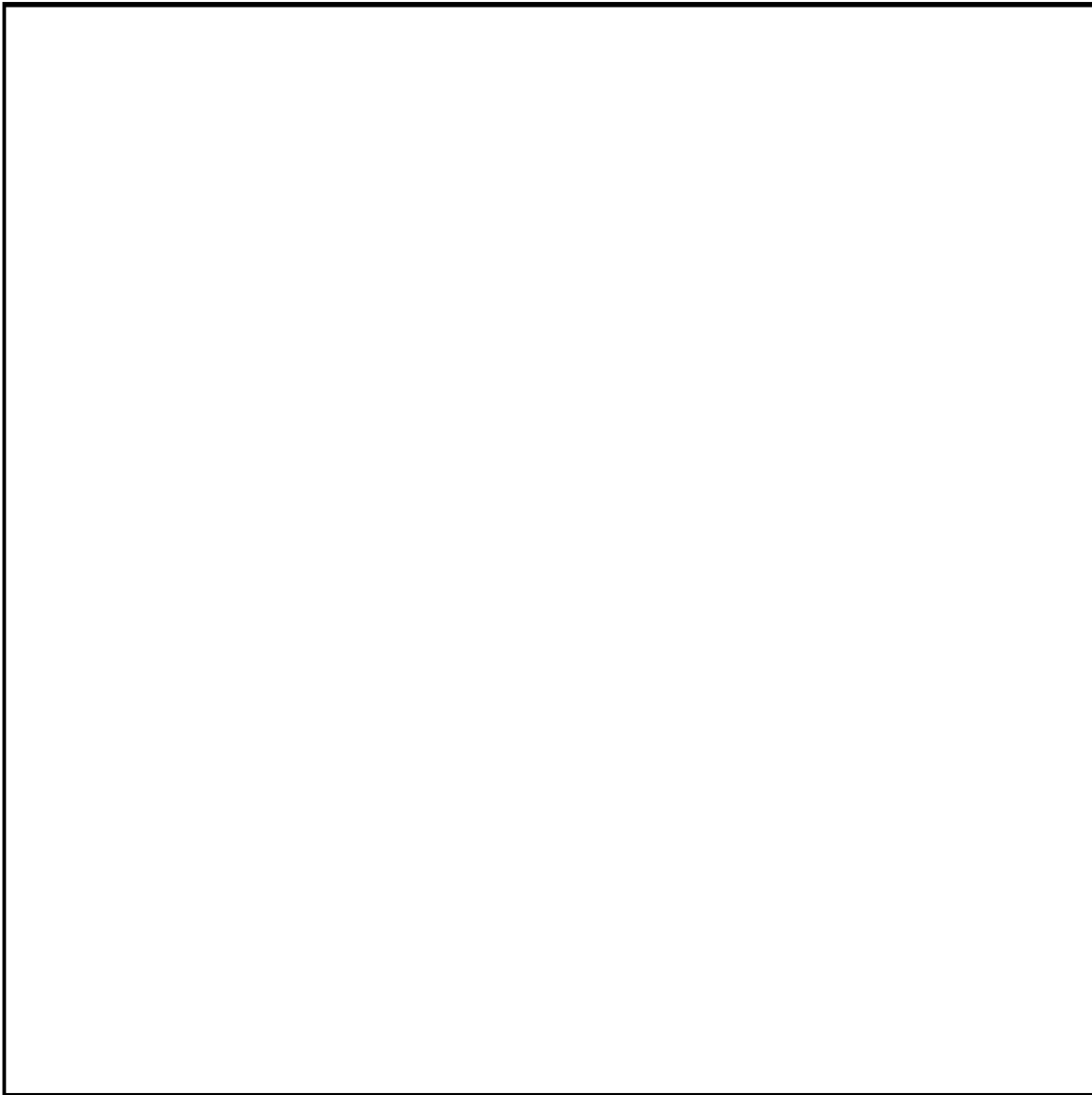

b6 Per Dept. of State

6. GUIDRY, MERCEDES (AKA WILLIAMS); 10/6/08 LOUISIANA;

NOK



INGLEWOOD,

CALIF., PHONE

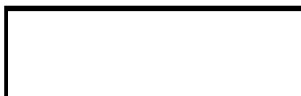

3



11. MOORE, CLARENCE EDWARD; AGE 6; NOK 

UNCLASSIFIED

b6 Per Dept. of State

UNCLASSIFIED

PAGE 03

STATE 300000

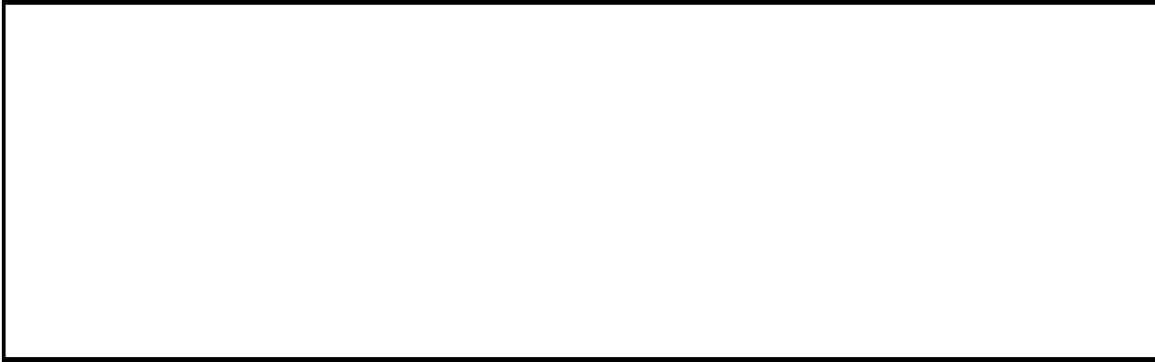

13. MCKENZIE, CLARA; 11/26/29, MACON, GEORGIA; NOK



LOS ANGELES, CALIF., PHONE



b6 Per Dept. of State

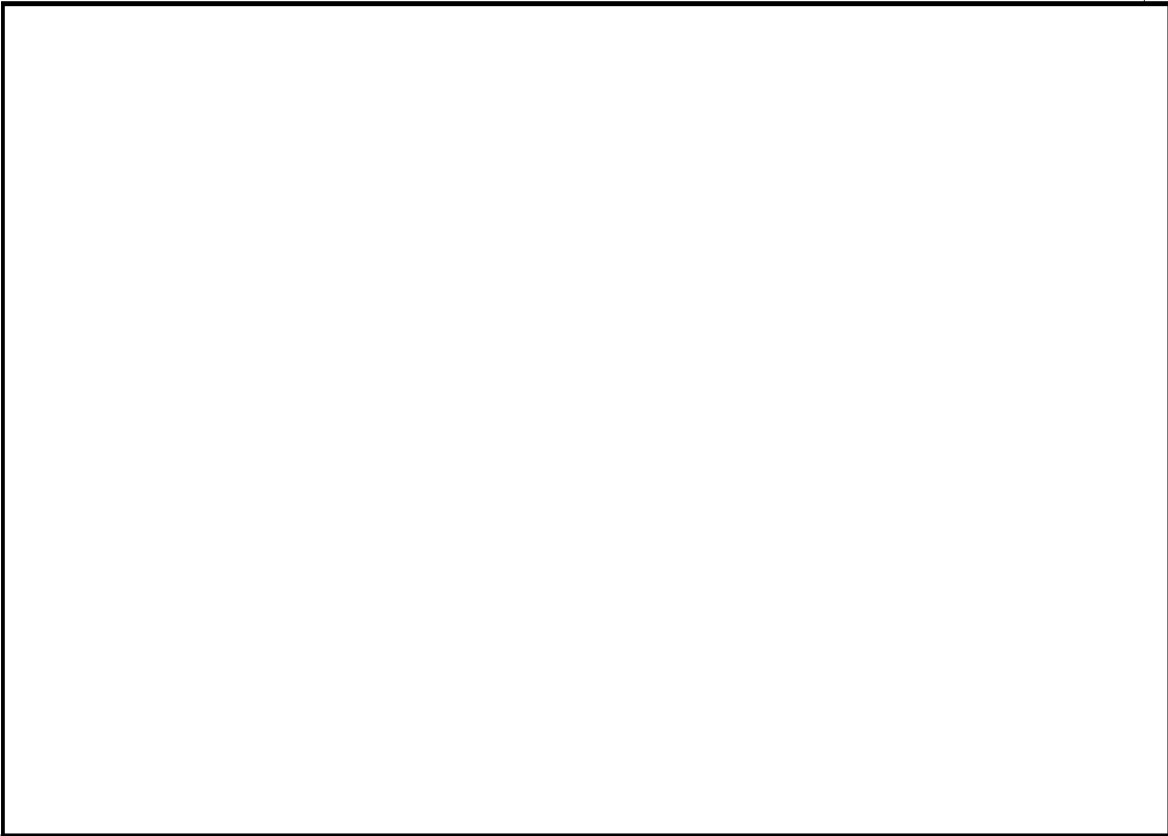

17. TURNER, ROOSEVELT; AGE 53; NOK

[REDACTED]

[REDACTED]

LONG BEACH, CALIF., PHONE

[REDACTED]

18. WADE, ROBERTA (HOSTINLV AGE 65, TEXAS; NOK SON

[REDACTED]

TULANE, CALIF., PHONE

[REDACTED]

b6 Per Dept. of State

[REDACTED]

20. WERREN, BRENDA; AGE 18; NOK

[REDACTED]

[REDACTED]

CHICAGO, ILLINOIS 60651, PHONE

[REDACTED]

[REDACTED]

UNCLASSIFIED

~~CONFIDENTIAL~~

FBB682



Assoc. Dir.	
Dep. AD Adm.	
Dep. AD Inv.	
Asst. Dir.:	
Adm. Serv.	
Crim. Inv.	
Ident.	
Insp.	
Intell.	
Lab.	
Legal Coun.	
Plan. & Insp.	
Rec. Mgmt.	
Tech. Serv.	
Training	
Public Aff. Off.	
Telephone Rm.	
Director's Sec'y	

PAGE 01 GEORGE 03953 262328Z

ACTION L-03

27 Nov 78 00

INFO OCT-01 ARA-11 ISO-00 SOG BY 262328Z SSO-00 H-01
SS-15 JUSE-00 FBIE-00 /038 W

FEDERAL BUREAU OF INVESTIGATION COMMUNICATIONS SECTION

-----AAAAA
ALL INFORMATION CONTAINED
HEREIN IS UNCLASSIFIED
DATE 9/24/92 BY 1048 DML/MLK

0 262210Z NOV 78D

FM AMEMBASSY GEORGETOWN

TO SECSTATE WASHDC NIACT IMMEDIATE 8223

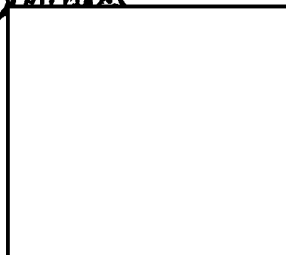

~~CONFIDENTIAL~~ GEORGETOWN 03953

FEDERAL GOVERNMENT

E.O. 11652: GDS

TAGS: CASC OREP BY AFSP

SUBJECT: ENGAGEMENT OF LOCAL LEGAL COUNSEL TO ASSIST USG TO DISCHARGE RESPONSIBILITIES IN CONNECTION WITH JONESTOWN DISASTER AND ESTATES OF DECEASED AMERICANS.

Leo Ryan

b6 per FBI
b7C

REF: STATE 299133 AND PREVIOUS

REC-102

89-4286-425

HAVE REFLECTED AT SOME LENGTH ON IMPLICATIONS REFERRED TO IN PARA ONE REFTEL. CONTINUE TO FEEL, HOWEVER, THAT [REDACTED] IS THE BEST QUALIFIED LOCAL ATTORNEY AVAILABLE WHO HAS EXCELLENT ACCESS TO GOG MINISTRIES AND DEPARTMENTS WHILE AT THE SAME TIME BEING POLITICALLY NEUTRAL VIS-A-VIS THE BURNHAM GOVERNMENT. ANY OTHER CHOICE WILL BE LESS QUALIFIED AND/OR POLITICALLY

NOV 27 1978

TAINED. all
58 NOV 30 1978
BUR KE

NNNNVV FBA179

00 RUEHFB

DE RUEHSP #3399 3311321

ZNY CCCCC ZZH

O 27132Z NOV 78

FM AMEMBASSY PORT OF SPAIN

TO RUEHC/SECSTATE WASHDC NIACT IMMEDIATE 3288

RUEHCR/AMEMBASSY BRIDGETOWN NIACT IMMEDIATE 2559

RUEHFB/DIRECTOR FBI NIACT IMMEDIATE

INFO RUESON/AMEMBASSY GEORGETOWN PRIORITY 2072

BT

~~CONFIDENTIAL~~

FBI
ALL INFORMATION CONTAINED
HEREIN IS UNCLASSIFIED

DATE 9/24/92 BY 10486DKM/indm

LIMITED OFFICIAL USE PORT OF SPAIN 03399

FEDERAL GOVERNMENT

E. O. 11652: N/A

TAGS: CASC, OREP (RYAN, LEO), TD

SUBJECT: PEOPLES' TEMPLE MOVEMENT.

b6 per FBI
b7c

REFERENCES: (A) BRIDGETOWN 3455; (B) PORT OF SPAIN 3396

1. AS GOVERNMENT OF BARBADOS HAS AGREED TO PROPOSED VISIT (REFTEL A), AGENTS [] AND [] PLAN TO STOP IN BRIDGETOWN ENROUTE TO SAN JUAN UNLESS ADVISED TO THE CONTRARY BY FBI HEADQUARTERS. PLEASE ADVISE BY NIACT IMMEDIATE.

REC-102

89-4286

4-216
23 NOV 28 1978

2. FOR BRIDGETOWN: AS YOU INDICATED VESSEL HAD NOT ARRIVED SUNDAY EVENING, AGENTS WILL DEFER TRAVEL UNTIL TUESDAY. ETA NOVEMBER 28 AT 1045 HOURS ON FIA 602. PLEASE ARRANGE HOTEL ACCOMMODATIONS FOR TUESDAY EVENING AND ONWARD RESERVATIONS TO SAN JUAN FOR WEDNESDAY.

Assoc. Dir.	
Dep. AD Adm.	
Dep. AD Inv.	
Asst. Dir.:	
Adm. Serv.	
Crim. Inv.	
Ident.	
Intell.	
Laboratory	
Legal Coun.	
Plan. & Insp.	
Rec. Mgmt.	
Tech. Servs.	
Training	
Public Affs. Off.	
Telephone Rm.	
Director's Sec'y	

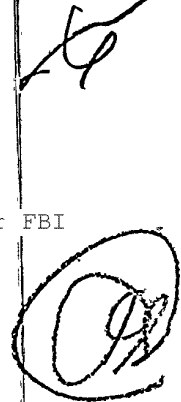

Assoc. Dir.	_____
Dep. AD Adm.	_____
Dep. AD Inv.	_____
Asst. Dir.:	_____
Adm. Serv.	_____
Crim. Inv.	_____
Ident.	_____
Intell.	_____
Laboratory	_____
Legal Coun.	_____
Plan. & Insp.	_____
Rec. Mgnt.	_____
Tech. Servs.	_____
Training	_____
Public Affs. Off.	_____
Telephone Rm.	_____
Director's Sec'y	_____

IP0006 3312244Z

77 Nov 78 23 17z

OO HQ CO SF

DE IP

RECEIVED
FEDERAL BUREAU
OF INVESTIGATION
COMMUNICATIONS SECTION

0 272244Z NOV 78

FM INDIANAPOLIS (89-181) (P)

TO DIRECTOR IMMEDIATE

COLUMBIA IMMEDIATE

SAN FRANCISCO IMMEDIATE

BT

ALL INFORMATION CONTAINED
HEREIN IS UNCLASSIFIED
DATE 9/24/92 BY 1008 OKA/kub

UNCLAS

RYMUR; OO: SF.

RE IPTELCAL TO BUREAU, NOVEMBER 27, 1978 (u)

FOR INFORMATION RECEIVING OFFICES, THE FOLLOWING IS
A SUMMARY OF INFORMATION PROVIDED BY CHARLOTTE ALETHA
BALDWIN, NEE LAMB, BORN AUGUST 4, 1905, RICHMOND, INDIANA, AND
HER HUSBAND, WALTER REED BALDWIN, BORN JUNE 4 (7), 1904,
RICHMOND, INDIANA, WHO RESIDE 149 SOUTHWEST 16TH STREET,
RICHMOND, INDIANA, TELEPHONE (317) 935-2189. BALDWINS ARE THE
PARENTS OF MARCELINE MAE JONES, NEE BALDWIN, WHITE FEMALE,
BORN JANUARY 8, 1927, UNIONDALE, INDIANA, AND IS THE WIFE OF
JAMES WARREN JONES, WHITE MALE, BORN MAY 13, 1931, LYNN, (u)

REC-102 89-4286-427

58 NOV 30 1978

b6
b7c

PAGE TWO (IP 89-181) UNCLAS

RANDOLPH COUNTY, INDIANA. MARRIAGE OCCURRED JUNE 12, 1949, RICHMOND, INDIANA. EMPLOYED AS A MALE ORDERLY REID MEMORIAL HOSPITAL, DURING TIME MARCELINE RECEIVED CERTIFICATION AS A REGISTERED NURSE AT REID MEMORIAL HOSPITAL, RICHMOND, INDIANA. FOLLOWING MARRIAGE, BOTH ATTENDED INDIANA UNIVERSITY, FOR TWO YEARS WHEN JONES SUBSEQUENTLY TRANSFERRED TO BUTLER UNIVERSITY, INDIANAPOLIS, INDIANA, WHERE HE RECEIVED DEGREE IN EDUCATION. IN 1951, JONES BECAME INTERESTED IN SOCIAL GOSPEL ACTIVITIES AND AFFILIATED HIMSELF WITH THE METHODIST CHURCH, BEECH GROVE, AND INDIANAPOLIS, INDIANA. AS ASSISTANT PASTOR, SUNSET METHODIST CHURCH, BEECH GROVE, INDIANA, FOR ONE YEAR AND A METHODIST CHURCH IN INDIANAPOLIS, JONES ATTEMPTED TO INTEGRATE CHURCH MEMBERSHIP, BUT FAILED TO DO SO. HE LEFT METHODIST AFFILIATION TO BECOME ACTIVE WITH ASSEMBLY OF GOD, AGAIN FAILING IN HIS INTEGRATION EFFORTS AND LEFT THIS CHURCH GROUP. JONES, AT AGE 22, PURCHASED JEWISH TEMPLE ON 10TH STREET, INDIANAPOLIS, WHERE HE ESTABLISHED PEOPLES TEMPLE. JONES WAS APPOINTED DIRECTOR OF MAYOR'S COMMISSION ON HUMAN RIGHTS DURING ADMINISTRATION OF MAYOR CHARLES BOSWELL, INDIANAPOLIS, INDIANA.

(u)

PAGE THREE (IP 89-181) UNCLAS

DURING 1960 OR EARLY 1961, JONES REFUSED MEDICAL TREATMENT AT METHOD I ST HOSPITAL AT INDIANAPOLIS UNTIL FACILITIES WERE INTEGRATED. DURING CHURCH ACTIVITIES AT BEECH GROVE, INDIANA, JONES ADOPTED 11 YEAR OLD GIRL NAMED AGNES. STEVEN JONES, AGE 19, IS THE ONLY NATURAL ISSUE TO THE UNION OF JAMES AND MARCELINE JONES. JONES SUBSEQUENT TO MOVE TO CALIFORNIA, ADOPTED SUZANNE, WHO IS NOW MARRIED AND AN EMPLOYEE OF THE U.S. GOVERNMENT, DEPARTMENT OF HEALTH, EDUCATION, AND WELFARE, SAN FRANCISCO, UNDER HER MARRIED NAME OF SUZANNE CARTNELL. SHE IS OF KOREAN DESCENT AND ABOUT 24 YEARS OF AGE. SHE WAS A FORMER MEMBER OF THE PEOPLES TEMPLE, SAN FRANCISCO, CALIFORNIA, AND INCURRED THE IRE OF JONES WHEN SHE SEPARATED HER AFFILIATION WITH THE PEOPLES TEMPLE. JONES ALSO ADOPTED LEW JONES, AGE 22, OF KOREAN EXTRACTION, WHO IS MARRIED TO TERRIE OR TERRY, AND HAS ONE CHILD, CHI-OK, AGE APPROXIMATELY ONE AND ONE-HALF YEARS. ADDITIONALLY, AGNES WHO WAS MARRIED ON TWO PRIOR OCCASIONS, IS CURRENTLY MARRIED TO RAY JONES (NO RELATION) AND HAS FOUR CHILDREN, BILLY, AGE 17; STEPHANIE, AGE 16; JIMBO, AGE 14; AND MICHAEL, AGE 8.

PAGE FOUR (IP 89-181) UNCLAS

JOHN JONES, AGE 6, IS THE ILLEGITIMATE ISSUE BETWEEN JAMES JONES AND GRACE STONE. THE FOREGOING PERSONS WERE OBSERVED AT JONESTOWN BY THE BALDWIN DURING OCTOBER-NOVEMBER 1978. STEVEN, JIM AND TIM JONES ARE THE ONLY KNOWN SURVIVORS. IN 1961, JONES AND FAMILY MOVED FROM INDIANAPOLIS, INDIANA, TO BELLE HORIZONTE, BRAZIL, SOUTH AMERICA, WHERE THEY REMAINED UNTIL 1963. DURING FEBRUARY 1962, MR. AND MRS. BALDWIN VISITED JONES IN BELLE HORIZONTE. JONES RETURNED TO INDIANAPOLIS, INDIANA, DURING 1963, TO CONTINUE HIS EFFORTS WITH THE PEOPLES TEMPLE. HE WAS SUBJECTED TO HARASSMENT, HAVING SHOTS FIRED INTO THE HOME, BRICKS, ROCKS AND OTHER ITEMS THROWN THROUGH THE WINDOWS, AND HARASSING TELEPHONE CALLS. IN 1964, JONES DECIDED TO SELL THE INDIANAPOLIS TEMPLE AND MOVE TO CALIFORNIA WHERE HE BELIEVED HIS FAMILY WOULD NOT BE HARASSED AND THE PEOPLE WOULD BE MORE RESPECTIVE TO HIS SOCIAL REFORM PHILOSOPHY. APPROXIMATELY 100 PERSONS LEFT INDIANAPOLIS TO FOLLOW JONES TO SAN FRANCISCO, CALIFORNIA, WHERE HE ESTABLISHED A PEOPLES TEMPLE. AMONG THOSE WERE DALE AND EDITH PARKS, FROM COLUMBUS, INDIANA. BOTH PARKS ARE KNOWN TO THE BALDWINS FOR 14 YEARS. DURING THE

(u)

PAGE FIVE (IP 89-181) UNCLAS

JONESTOWN VISIT, MRS. BALDWIN OBSERVED EDITH PARKS DISPLAYED A STRAINED RELATIONSHIP TOWARD HER AND WOULD LEAVE ANY GROUP WHERE MRS. BALDWIN WAS PRESENT. (u)

MARCELINE JONES WAS EMPLOYED BY THE CALIFORNIA STATE DEPARTMENT AND INVOLVED IN PUBLIC HEALTH INVESTIGATIONS REGARDING CONVALESCENT HOME LICENSING IN CALIFORNIA. JONES WAS AFFILIATED WITH THREE CHURCHES IN SOCIAL GOSPEL ACTIVITIES IN ADDITION TO THE PEOPLES TEMPLE ACTIVITIES. GRACE STONE, THE WIFE OF TIM STONE, ATTORNEY IN SAN FRANCISCO, WAS ATTRACTED TO JAMES JONES AND REPORTEDLY GAVE BIRTH TO JOHN JONES, SUPRA. TIM STONE REPORTEDLY THREATENED JAMES JONES WITH EXPOSURE IF HE REFUSED TO LEAVE THE SAN FRANCISCO AREA. IN APRIL 1976, JONES DECIDED TO LEAVE SAN FRANCISCO FOR JONESTOWN, GUYANA, SOUTH AMERICA, IN AN EFFORT TO AVOID EXPOSURE AS THREATENED BY STONE. MARCELINE JONES TERMINATED HER EMPLOYMENT WITH THE CALIFORNIA STATE DEPARTMENT AT THE DIRECTION OF JAMES JONES FOR THE PURPOSE OF OVERSEEING THE OPERATIONS OF THE PEOPLES TEMPLE IN SAN FRANCISCO, CALIFORNIA. BALDWIN WERE AWARE OF THE UNHAPPY MARRIED LIFE AND STRAINED RELATIONS WHICH

(u)

5

PAGE SIX (IP 89-181) UNCLAS

EXISTED BETWEEN MARCELINE AND JAMES JONES. IN OCTOBER 1978, MARCELINE JONES RETURNED TO THE U.S., SPENDING ABOUT THREE WEEKS IN SAN FRANCISCO, PRIOR TO HER ARRIVAL IN RICHMOND, INDIANA, ON OCTOBER 21, 1978. SHE EXPRESSED CONCERN TO HER PARENTS REGARDING THE FAILING HEALTH AND MENTAL ATTITUDE OF JIM JONES. SHE EXPRESSED A THOUGHT THAT SHE BELIEVED JONES WAS PROBABLY USING DRUGS AND STATED SHE HAD INTENTION OF FINDING OUT IF THIS WAS TRUE UPON HER RETURN TO JONESTOWN. BALDWINS ACCOMPANIED MARCELINE JONES FROM NEW YORK TO JONESTOWN ON OCTOBER 26, 1978, ARRIVING AT JONESTOWN ON OCTOBER 30, 1978. THEY DEPARTED JONESTOWN NOVEMBER 13, ARRIVED AT GEORGETOWN AND DEPARTED GEORGETOWN, GUYANA, NOVEMBER 15, 1978, ARRIVING IN RICHMOND, INDIANA, AT APPROXIMATELY 12:30 AM ON THE MORNING OF NOVEMBER 16, 1978. DURING THIS VISIT, BALDWINS OBSERVED JONES ON THREE SEPARATE OCCASIONS. JONES MAINTAINED A SEPARATE COTTAGE AND WAS IN COMPANY OF TWO PARAMORES, MARIE (LNU), WHO HANDLED THE FINANCIAL MATTERS FOR JONESTOWN AND CAROLYN MOORE, WHOSE PARENTS RESIDE IN RENO, NEVADA, WHERE HER FATHER IS A

(u)

6

PAGE SEVEN (IP 89-181) UNCLAS

METHODIST MINSITER. JONES SPENT MOST OF HIS TIME IN HIS COTTAGE DUE TO HIS ILLNESS. JONES ADMITTED TO THE BALDWINS THAT HE WAS EXPERIENCING GREAT PRESSURES FROM TIM STONE AND BELIEVED THAT HE HAD BEEN TRICKED BY STONE. JONES CRIED WHEN DISCUSSING HIS INVOLVMENT WITH GRACE STONE AND THE BIRTH OF JOHN JONES. MRS. BALDWIN COMMENTED TO HIM ABOUT THE SWOLLEN CONDITION OF HIS HANDS NOTING THEY WERE SWOLLEN TO AT LEAST TWICE THE SIZE HIS HANDS WOULD HAVE BEEN IF NORMAL. SHE DID NOT LEARN THE NATURE OF HIS ILLNESS OR IF HE WAS USING DRUGS. ON TWO SUBSEQUENT OBSERVATIONS, NO EXCHANGE OF CONVERSATION OCCURRED. BALDWINS HAVE NO KNOWLEDGE REGARDING A SUICIDE PACT OR ANY AGREEMENT EXISTING AMONG MEMBERS OF THE PEOPLES TEMPLE. THEY STATED THEY HAD NEVER BEEN TOLD BY JAMES JONES, MARCELINE JONES, OR ANY OTHER PERSON KNOWN TO BE ASSOCIATED IN ANY WAY WITH, BY MEMBERSHIP OR OTHERWISE, OF THE EXISTENCE OF A SUICIDE PACT OR ANY KIND OF AGREEMENT BY MEMBERS TO PARTICIPATE IN THE MURDER AGAINST MEMBERS OF THE GROUP OR ANY PERSON INVOLVED IN THE SERVICE OF THE U.S. GOVERNMENT OR ANY OTHER GOVERNMENTAL ORGANIZATION OF THE WORLD.

(4)

7

PAGE EIGHT (IP 89-181) UNCLAS

FD-302S DETAILING RESULTS OF INTERVIEW BEING FORWARDED
BY SEPARATE COMMUNICATION. (u)

ARMED AND DANGEROUS. (u)

BT

#



BU0002 3311903Z

27 NOV 78 19 08z

Assoc. Dir.	
Dep. AD Adm.	
Dep. AD Inv.	
Asst. Dir.:	
Adm. Serv.	
Crim. Inv.	<input checked="" type="checkbox"/>
Ident.	
Intell.	
Laboratory	
Legal Coun.	
Plan. & Insp.	
Rec. Mgnt.	
Tech. Servs.	
Training	
Public Affs. Off.	
Telephone Rm.	
Director's Sec'y	

TO HQ SF
DE BU

RECEIVED
FEDERAL BUREAU
OF INVESTIGATION
COMMUNICATIONS SECTION

271900Z NOV 78

FM BUFFALO (89-96) (P)

TO DIRECTOR IMMEDIATE

SAN FRANCISCO IMMEDIATE

BT

ALL INFORMATION CONTAINED
HEREIN IS UNCLASSIFIED
DATE 9/24/92 BY 1049 DDM/HML

UNCLAS E F T O

RYMUR

ON NOV. 27, 1978,

[Redacted]

(9)

[Redacted] N.Y. (PROTECT IDENTITY), ADVISED AFTER READING RECENT PUBLICITY REGARDING CAPTIONED, THAT HE IS A "HAM RADIO OPERATOR" AND ON AUG. 17, 1978, RECEIVED RADIO MESSAGE FROM UNKNOWN FEMALE PURPORTED TO BE MEDICAL TECHNICIAN AT JONES TEMPLE, GUYANA. [Redacted] EXPLAINED THAT FEMALE OPERATOR, USING HAM OPERATOR CALL LETTERS WB6MID/8R3, STATED THAT SHE DESIRED [Redacted] TO MAKE A LONG DISTANCE TELEPHONE CALL TO TELEPHONE NUMBER 415-922-9597, AND DETERMINE IF MEDICAL PACKAGE HAD BEEN SHIPPED FROM SAN FRANCISCO, CALIFORNIA, TO JONES TEMPLE IN GUYANA. [Redacted] STATED THIS REQUEST IS NOT AN UNUSUAL ONE AS HAM OPERATORS OUTSIDE CONTINENTAL U.S. OFTEN WILL REQUEST

b6
b7c

REC-102 89-4286-428

NOV 28 1978

(u) [Signature]

58 NOV 30 1978

4
d O
PAGE TWO BU 89-96 UNCLAS E F T O .

CALLS BE MADE. [REDACTED] STATED THAT CALL LETTERS USED BY
FEMALE OPERATOR ACTUALLY ARE ASSIGNED TO A MALE OPERATOR AT
JONES TEMPLE WHOSE NAME RECENTLY APPEARED AS BEING FOUND DEAD
AT JONES TEMPLE. (u)

b6
b7C

SAN FRANCISCO DETERMINE SUBSCRIBER TO TELEPHONE NUMBER
415-922-9597 AND CONDUCT APPROPRIATE INVESTIGATION. (u)

BUFFALO WILL MAINTAIN CONTACT WITH [REDACTED] (u)

BT

#

2

Assoc. Dir.	
Dep. AD Adm.	
Dep. AD Inv.	
Asst. Dir.:	
Adm. Serv.	X
Crim. Inv.	X
Ident.	
Intell.	
Laboratory	
Legal Coun.	
Plan. & Insp.	
Rec. Mgnt.	
Tech. Servs.	
Training	
Public Affs. Off.	
Telephone Rm.	
Director's Sec'y	

27 NOV 78 19 33z

RECEIVED
FEDERAL BUREAU
OF INVESTIGATION
COMMUNICATIONS SECTION

BT0001 331 1930Z

E HQ SF

DE BT

E 271930Z NOV 78

FM BUTTE (89-166) (P)

[Handwritten initials]

TO DIRECTOR (89-4286) (IMMEDIATE)

SAN FRANCISCO (89-250) (IMMEDIATE)

ALL INFORMATION CONTAINED
HEREIN IS UNCLASSIFIED
DATE 9/24/82 BY 1048 Bcm/mbm

BT

UNCLAS
RYMHR

[Handwritten initials in a circle]

RE BUTTE TELETYPE TO BUREAU AND SAN FRANCISCO, NOVEMBER 24,
1978. (u)

REFERENCED TELETYPE INDICATES MARY THERESA CARTER JONES
TRAVELED TO JONESTOWN, GUYANA, PRIOR TO CHRISTMAS, 1966.

SHE ACTUALLY TRAVELED TO JONESTOWN PRIOR TO CHRISTMAS, 1974,
(INSTEAD OF 1966), TO DELIVER CHRISTMAS PRESENTS TO RESIDENTS
OF THE COMMUNITY AND RETURNED TO THE UNITED STATES A FEW DAYS
LATER. SHE SUBSEQUENTLY TRAVELED AGAIN TO JONESTOWN
ABOUT MARCH, 1977. (u)

REC-102 89-4286-429

NOV 28 1978

FD-302 FOLLOWS. (u)

ARMED AND DANGEROUS; SUICIDAL TENDENCIES. (u)

BT

58 NOV 30 1978

Assoc. Dir.	
Dep. AD Adm.	
Dep. AD Inv.	
Asst. Dir.:	
Adm. Serv.	X
Crim. Inv.	X
Ident.	
Intell.	
Laboratory	
Legal Coun.	
Plan. & Insp.	
Rec. Mgmt.	
Tech. Servs.	
Training	
Public Affs. Off.	
Telephone Rm.	
Director's Sec'y	

27 Nov 78 18 38z

FEDERAL BUREAU OF INVESTIGATION COMMUNICATIONS SECTION

ALL INFORMATION CONTAINED HEREIN IS UNCLASSIFIED DATE 9/29/92 BY 1048 DICK/rdb

FEDERAL GOVERNMENT

Leo Ryan



REC-102

89-4286-430

27 NOV 29 1978

do

Declassified per DOD letter 7/21/2005 65179DMH/ST/bpg

NNNNVV FBA245

DD RUEHFB

DE RUEKJCS #2805 3311815

ZNY CCCCC

O 271744Z NOV 78

FM JCS WASHINGTON DC//J3//

TO RULPALJ/USCINCSO QUARRY HEIGHTS CZ

RUCIMAA/CINCMAC SCOTT AFB IL

RUCJAAA/USCINCPAC MACDILL AFB FL

INFO ZEN/SECDEF WASHINGTON DC

RUSNAAA/USCINCEUR VAIHINGEN GE

RUHQHQA/CINCPAC HONOLULU HI

RUWRNLB/CINCPAC PETERSON AFB CO

RUCIPBA/USCINCPAC LANGLEY AFB VA

RUEHC/SECSTATE WASHINGTON DC

RUEADWW/WHITE HOUSE WASHINGTON DC//SITROOM//

RUWTEKA/CINCSAC OFFUTT AFB NE

RUETIAA/DIRNSA FT GEORGE G MEADE MD

RUESON/AMEMB GEORGETOWN GY

RUEBHBA/2 IAF OC MCGUIRE AFB NJ//CAT//

RUCLSLA/437MAW CHARLESTON AFB SC

RUCLBMA/39ARRW EGLIN AFB FL

RUCBSAA/CINCLANT NORFOLK VA

RUWIMAB/AFMPC RANDOLPH AFB TX//MPCCM//

58 NOV 30 1978

PAGE 2 RUEKJCS 2805 ~~CONFIDENTIAL~~

RUEBEJA/436 ABG DOVER AFB DE//SVM//

RUEBEJA/436MAW DOVER AFB DE

RUCLHTD/USCINCARRED FT MCPHERSON GA

RUWTBGR/ARRS SCOTT AFB IL//CC//

RUEADWD/CSA WASHINGTON DC

RUENAAA/CNO WASHINGTON DC

RUEAHQA/CSAF WASHINGTON DC

RUEACMC/CMC WASHINGTON DC

RUEBJGA/COMDT COGARD WASHINGTON DC

RUEHFB/FBI WASHINGTON DC//DIR//

BT

~~CONFIDENTIAL~~ 4885

SUBJ: JCS SITREP 008/271700Z NOV 78 (FINAL)

(U) 1. ~~XX~~ SITUATION:

A. LAST FLIGHT CARRYING HUMAN REMAINS ARRIVED DOVER AFB 252355Z NOV 78 BRINGING TOTAL NUMBER OF BODIES RECOVERED FROM JONESTOWN TO 91

B. EIGHTY SURVIVORS HAVE BEEN IDENTIFIED IN GEORGETOWN: ONE HAS RETURNED TO US ON OWN: 47 DETAINED BY GOVERNMENT OF GUYANA (GOG)

AS UNFRIENDLY/POSSIBLY HOSTILE; 28 UNDER GOG HOUSE ARREST AS NON-MILITANTS; AND 4 IMPRISONED BY GOG AT GEORGETOWN. GOG HAS NOT INDICATED WHEN SURVIVORS WILL BE RELEASED.

(U) 2. ~~(C)~~ FRIENDLY OPERATIONS.

A. AS OF 271200Z NOV 78, 39 US MILITARY PERSONNEL REMAINED IN GEORGETOWN. JTF GUYANA WAS DISESTABLISHED AT 271145Z NOV 78 WHEN JTF COMMANDER RETURNED TO CANAL ZONE. ONLY US FORCES REMAINING IN GUYANA WILL BE 2 UH-1 HELICOPTERS AND CREWS SUPPORTING AMEMB GEORGETOWN. ADDITIONALLY, 3 HH-53S WILL REDEPLOY 281100Z NOV 78.

B. EXTENSIVE DAYLIGHT SEARCH OF JONESTOWN FAILED TO FIND ADDITIONAL BODIES OR SURVIVORS.

3. (U) GENERAL INFORMATION. DOD MAY BE TASKED TO AIRLIFT SURVIVORS FROM GEORGETOWN TO CONUS AFTER THEIR RELEASE BY GOG. DOD IS PREPARED TO HAVE AIRCRAFT IN GEORGETOWN 24 HOURS AFTER NOTIFICATION IF MILITARY AIRLIFT IS REQUIRED. GDS 84

BT

#2805

3

Assoc. Dir.	_____
Dep. AD Adm.	_____
Dep. AD Inv.	_____
Ass. Dir.:	_____
Adm. Serv.	_____
Crim. Inv.	_____ <i>Safar</i>
Ident.	_____
In'tel.	_____
Laboratory	_____
Legal Coun.	_____
Plan. & Insp.	_____
Rec. Mgmt.	_____
Tech. Servs.	_____
Training	_____
Public Affs. Off.	_____
Telephone Rm.	_____
Director's Sec'y	_____

NY0878 3310620

27 Nov 78 06 35z

OO HQ LA SF

DE NY 002

0 2 705 00

FEDERAL BUREAU OF INVESTIGATION
COMMUNICATIONS SECTION

FBI NEW YORK (89-495)

DIRECTOR (89-4286) IMMEDIATE

LOS ANGELES (89-436) IMMEDIATE (VIA FBIHQ)

SAN FRANCISCO (89-250) IMMEDIATE (VIA FBIHQ)

BT

UNCLAS
RYMUR

ALL INFORMATION CONTAINED
HEREIN IS UNCLASSIFIED
DATE 9/24/92 BY 1048 DKA/edm

Q

RE NY TELEPHONE CALL TO LA 11-26-78. (u)

FOR INFORMATION OF LOS ANGELES OFFICE MIGUEL DE PINA; DOB 9-29-1884

ARRIVED JFKIA 11-26-78 PAN AMERICAN FLIGHT 228 AT 640PM

ACCOMPANIED BY GRANDSON [REDACTED] DEPINA AND [REDACTED]

WERE BOTH INTERVIEWED BY SA OF FBI AT JFKIA. [REDACTED] ADVISED

THAT HE AND HIS GRANDFATHER WOULD BE DEPARTING TONIGHT TO LA. ON

TWA FLIGHT 17 ARRIVING IN LA. AT 11:45PM (u) *REC-102 89-4286-431*

[REDACTED] ADVISED THAT HIS GRANDFATHER DE PINA ²⁰ ~~29~~ NOV 28 1978

BE PERMANENTLY RESIDING WITH DE PINA'S DAUGHTER, [REDACTED]

[REDACTED] CARSON, CA. TELEPHONE NO. [REDACTED]

TELETYPE TO:
LA, SF 21
58 NOV 30 1978

b6
b7c

[REDACTED] FURTHER ADVISED THAT [REDACTED]

[REDACTED] AND HE WOULD BE AVAILIABLE

TO PROVIDE ANY INFORMATION AT THE FOLLOWING ADDRESS [REDACTED]

[REDACTED] LONG BEACH, CA. TELEPHONE NO. [REDACTED]

AND [REDACTED] AT LONG BEACH , CA. TELEPHONE

NO. [REDACTED] (u)

LA. SHOULD NOTE THAT DE PINA IS EXTREMELY ILL AND EXHAUSTED FROM HIS EXPERIANCE IN GUYANA AND FLIGHTS BACK TO UNITED STATES. LA SHOULD FURTHER NOTE THAT, DE PINA ADVISED THAT HE IS VERY FRIGHTENED AND FEARED THAT HIS LIFE IS IN DANGER. DEPINA ADVISED THAT REV. JIM JONES ORDERED MEMBERS OF THE COMMUNE TO GET HIM. (u)

LEADS: (u)

LA. WILL HAVE AGENTS MEET DE PINA AND [REDACTED] AT LOS ANGELES AIRPORT. LA. WILL VARIFY WHERE DE PINA WILL BE RESIDING AND WHEN HE WILL BE AVAILABLE FOR INTERVIEW. LA. WILL ALSO NOTIFY APPROPRIATE AUTHORITIES, LAPD, LONG BEACH PD. -, \$ AND CARSON PD. REGARDING THE SAFTY OF DE PINA. (u)

BT.

b6
b7c

27 Nov 78 15158z

RECEIVED
FEDERAL BUREAU
OF INVESTIGATION
COMMUNICATIONS SECTION

Assoc. Dir.	
Dep. AD Adm.	
Dep. AD Inv.	
Asst. Dir.:	
Adm. Serv.	
Crim. Inv.	<i>[initials]</i>
Ident.	
Intell.	
Laboratory	
Legal Coun.	
Plan. & Insp.	
Rec. Mgmt.	
Tech. Servs.	
Training	
Public Affs. Off.	
Telephone Rm.	
Director's Sec'y	

[Handwritten signature]



b6
b7C

O 271015Z NOV 78

FM PARIS (89-0)

TO DIRECTOR IMMEDIATE 311-27

BT

ALL INFORMATION CONTAINED
HEREIN IS UNCLASSIFIED
DATE 9/24/92 BY *[signature]*

UNCLAS E F T O

[circled] RYMUR

RE BUCAB NOVEMBER 22, 1978, AND PARCALL TO BUREAU
NOVEMBER 24, 1978. *(u)*

PARIS INDICES NEGATIVE RE JAMES WARREN JONES, PEOPLE'S
TEMPLE OF CHRISTIAN DISCIPLES OF GOD, AND CONGRESSMAN LEO J.

RYAN. *(u)*

BT

REC-102

89-4286-432

ES

[Handwritten signature]

211
58 DEC 1 1978

SF0831 3311958

OO HQ

DE SF 8301

O 2 1954Z NOV 78

FM SAN FRANCISCO (89-250) (P) (SQ. 10)

TO DIRECTOR (89-4286) IMMEDIATE

BT

27 Nov 78 20 01z

FEDERAL BUREAU OF INVESTIGATION COMMUNICATIONS SECTION

Assoc. Dir.	
Dep. AD Adm.	
Dep. AD Inv.	
Asst. Dir.:	
Adm. Serv.	
Crim. Inv.	
Ident.	
Intell.	
Laboratory	
Legal Coun.	
Plan. & Insp.	
Rec. Mgmt.	
Tech. Servs.	
Training	
Public Affs Off.	
Telephone Rm.	
Director's Sec'y	

ALL INFORMATION CONTAINED HEREIN IS UNCLASSIFIED DATE 9/24/92 BY 1045 DCM/pdm

UNCLAS
RYMUR

Q

IT WAS LEARNED TODAY, NOVEMBER 27, 1978, FROM CONGRESSMAN RYAN'S OFFICE IN SAN MATEO, CALIFORNIA, THAT THE ORIGINALS OF A LETTER FROM ATTORNEY MARK LANE TO CONGRESSMAN RYAN, DATED NOBEMBER 6, 1978, AND CONGRESSMAN RYAN'S REPLY TO MARK LANE, DATED NOBEMBER 10, 1978, AND A LETTER FROM CONGRESSMAN RYAN TO REVEREND JIM JONES, DATED NOBEMBER 1, 1978, ALL PERTAINING TO CONGRESSMAN RYAN'S PLANNED TRIP TO GUYANA, ARE LOCATED AT CONGRESSMAN RYAN'S OFFICE IN WASHINGTON, D.C. (u)

REC-102 89-4286-433

LEAD. WFO. AT WASHINGTON, D.C. WILL OBTAIN ORIGINALS OF THE ABOVE DESCRIBED CORRESPONDENCE. (u)

"ARMED AND DANGEROUS. SUICIDAL TENDENCIES" (u)

BT

SP

211
58 NOV 30 1978

Assoc. Dir.	_____
Dep. AD Adm.	_____
Dep. AD Inv.	_____
Asst. Dir.:	
Adm. Serv.	_____
Ident.	_____
Intell.	_____
Laboratory	_____
Legal Coun.	_____
Plan. & Insp.	_____
Rec. Mgnt.	_____
Tech. Servs.	_____
Training	_____
Public Affs. Off.	_____
Telephone Rm.	_____
Director's Sec'y	_____

MM0013 3312140Z

27 Nov 78 21 50z

OO HI SF

RECEIVED
FEDERAL BUREAU
OF INVESTIGATION
COMMUNICATIONS SECTION *MB*

DE MM

O 272140Z NOV 78

JM FM MIAMI (89-179) P

TO DIRECTOR (89-4286) IMMEDIATE

ALL INFORMATION CONTAINED
HEREIN IS UNCLASSIFIED
DATE 9/24/92 BY 1048 DKM/MLL

JM SAN FRANCISCO (89-250) IMMEDIATE

BT

UNCLAS
RYMUR.

(Handwritten initials)

RE BUREAU TELETYPES TO ALL OFFICES; MIAMI TELETYPES TO BUREAU; MILWAUKEE TELETYPE TO BUREAU, ALL NOVEMBER 24, 1978, HOUSTON TELETYPE TO BUREAU; BUFFALO TELETYPE TO BUREAU AND CHICAGO TELETYPE TO BUREAU, ALL NOVEMBER 25, 1978; AND MIAMI TELCALL TO BUREAU, NOVEMBER 27, 1978 ^(u)

REC-102 89-4286-434

WALTER THAIN, INTERVIEWED THIS P.M. AT HIS LABORATORY, 170 WEST SPANISH RIVER BOULEVARD, BOCA RATON, FLORIDA, TEL. NO. 392-6622. HE ADVISED HE WAS IN GUYANA LATE APRIL-EARLY MAY, THIS YEAR, AS A SIDE TRIP FROM BUSINESS IN VENEZUELA. THAIN VISITED JONESTOWN, TOURED IT AND DINED WITH JIM JONES APPROXIMATELY SIX TIMES. WHILE IN GUYANA, HE TOOK PHOTOS

(Handwritten initials and marks)

58 NOV 30 1978

PAGE TWO MM 89-179 UNCLAS

MOSTLY IN GEORGETOWN, BUT ALSO PHOTOGRAPHED JONESTOWN. HE ALSO SPOKE TO A NUMBER OF PEOPLE'S TEMPLE (PT) WHILE THERE. (u)

FOLLOWING HIS RETURN TO U.S., THAIN RECEIVED SEVERAL HUNDRED LETTERS FROM PT MEMBERS IN GUYANA, SOME QUITE RECENT. (u)

ADDITIONALLY, THAIN HAS TAPE RECORDING OF APPROXIMATELY FIVE HOURS OF RADIO CONVERSATION WITH PT IN JONESTOWN DURING FEBRUARY, 1978. CONVERSATION DEALT WITH CAESARIAN DELIVERY OF INFANT(S) AT JONESTOWN. THAIN OFTEN PROVIDES MEDICAL ASSISTANCE TO "HAM" RADIO OPERATORS. (u)

HE STATED, TO HIS RECOLLECTION, THERE WAS NEVER ANY INDICATION DURING VISIT, RADIO CONVERSATIONS, OR LETTERS OF PLANS TO MURDER CONGRESSMAN RYAN OR OTHERS. NOR WAS THERE INDICATION OF IMPENDING VIOLENCE OF ANY TYPE. (u)

THAIN AGREED TO PROVIDE PHOTOS, TAPE AND LETTERS TO FBI. HE NOTED, HOWEVER, HE ARRANGED FOR NBC NEWSMAN, (SEE REFERENCED CHICAGO TELETYPE) TO LISTEN TO TAPE PRIOR TO RELEASING SAME TO FBI. ABOVE ITEMS WILL BE OBTAINED AT EARLIEST OPPORTUNITY. (u)

BUREAU TELEPHONICALLY ADVISED OF ABOVE. (u)

b6
b7c

PAGE THREE MM 89-179 UNCLAS

THIS DATE, [REDACTED] BRITISH WEST INDIES AIRLINE (BWIA),
MIAMI, ADVISED PILOT [REDACTED] DUE TO ARRIVE MIAMI FROM BWI
TOMORROW, 4:30 P.M. (u)

DURING LATE EVENING, NOVEMBER 26, 1978, DR. [REDACTED]
LOCATED AT RESIDENCE OF DR. [REDACTED]

[REDACTED] FORT PIERCE, FLORIDA. [REDACTED] ADVISED HE HAD ONLY
ONE RADIO CONTACT WITH JONESTOWN SOMETIME LAST SPRING. HE
DESCRIBED CONVERSATION ONLY AS A "PASSING" ONE AND THAT JONESTOWN
WAS ATTEMPTING TO ELICIT MEDICAL ADVICE. [REDACTED] NOTED JONESTOWN
OPERATOR WAS FEMALE WITH APPARENT MEDICAL BACKGROUND, POSSIBLY
A NURSE. QUESTIONS FROM JONESTOWN APPARENTLY CONCERNED DELIVERY
OF TWINS. DURING CONVERSATION, ANOTHER "HAM" OPERATOR, BELIEVED
BASED IN CALIFORNIA AND THOUGHT BY [REDACTED] TO BE A DR., JOINED
CONVERSATION. [REDACTED] STATED CONVERSATION WAS LIMITED TO ABOVE
MEDICAL MATTER AND COULD FURNISH NO FURTHER INFO RE PT. (u)

FOR INFO, STATION CAL SIGN [REDACTED] (SEE REFERENCED HOUSTON
TELETYPE) ASSIGNED [REDACTED], KEY WEST, FLORIDA. [REDACTED]
PREVIOUSLY INTERVIEWED, THIS MATTER (u)

EFFORTS TO LOCATE AND INTERVIEW "HAM" RADIO OPERATOR [REDACTED]

[REDACTED], NEGATIVE TO DATE. (u)

b6
b7c

PAGE FOUR MM 89-179 UNCLAS

MIAMI AT BOCA RATON, WILL OBTAIN PHOTOS, LETTERS AND TAPE
FROM [REDACTED] (u)
AT MIAMI, WILL INTERVIEW [REDACTED] UPON HIS ARRIVAL
IN U.S., NOVEMBER 28, 1978. (u)

b6
b7C

AT FORT LAUDERDALE, WILL CONTINUE EFFORTS TO LOCATE AND
INTERVIEW [REDACTED] (u)
ARMED AND DANGEROUS. SUICIDAL TENDENCIES. (u)

BT

#

4

LA0001 3312000Z

OO HQ SF

DE LA

O 272000Z NOV 78

FM LOS ANGELES (89-436) (3) (P)

TO DIRECTOR (89-4286) IMMEDIATE

SAN FRANCISCO (89-250) IMMEDIATE (SF VIA FBIHQ)

BT

UNCLAS

RYMUR; OO: SAN FRANCISCO.

ON NOVEMBER 24, 1978, THE LOS ANGELES FBI OFFICE WAS INVITED TO OBSERVE A SEARCH WARRANT CONDUCTED ON TWO LOCATIONS BY THE OFFICE OF THE DISTRICT ATTORNEY, BUREAU OF INVESTIGATIONS, COUNTY OF LOS ANGELES.

THE LOCATIONS SEARCHED WERE CRESTWOOD ESCROW, 401 EAST MANCHESTER, SUITE 209, LOS ANGELES, CALIFORNIA, AND ENOLA M. NELSON REALTY, 3840 CRENSHAW BOULEVARD, LOS ANGELES, CALIFORNIA (u)

THE FBI PROVIDED ONE SPECIAL AGENT AT EACH LOCATION NOTING THAT THEIR ROLE WOULD BE STRICTLY ONE OF AN OBSERVER FOR CAPTIONED MATTER (u)

THE SEARCH AT CRESTWOOD ESCROW FAILED TO (u)

TELETYPED TO:

58 NOV 30 1978

77 Nov 78 20 10z

RECEIVED
FEDERAL BUREAU
OF INVESTIGATION
COMMUNICATIONS SECTION

ALL INFORMATION CONTAINED
HEREIN IS UNCLASSIFIED
DATE 9/24/92 BY 1018 DIC/mlh

Assoc. Dir.	
Dep. AD Adm.	
Dep. AD Inv.	
Asst. Dir.:	
Adm. Serv.	
Crim. Inv.	
Ident.	
Intell.	
Laboratory	
Legal Coun.	
Plan. & Insp.	
Rec. Mgnt.	
Tech. Servs.	
Training	
Public Affs. Off.	
Telephone Rm.	
Director's Sec'y	

[Redacted box with handwritten initials]

b6
b7C

REC-102 89-4286-435

23 NOV 28 1978

[Handwritten signature]

PAGE TWO (LA 89-436) UNCLAS

PROVIDE ANY INFORMATION OF VALUE TO CAPTIONED
MATTER. (u)

THE SEARCH AT ENOLA M. NELSON REALTY COMPANY
BEING OWNED BY A FEMALE WHO IS THE SISTER OF JAMES
MC ELVANE, WHO WAS THE REPORTED LEADER OF THE
PEOPLE'S TEMPLE CHURCH IN LOS ANGELES AT ONE TIME (u)

THE SEARCH AT ENOLA M. NELSON REALTY COMPANY
WHERE MC ELVANE IS A SALESMAN REVEALED THE FOLLOWING
ITEMS IN A DESK WHOSE USER IS NOT KNOWN: (u)

ONE HOAX BOMB WHICH CONSISTED OF TWO D-CELL
BATTERIES, APPROXIMATE THREE-AND-ONE-HALF-INCH BY
ONE-AND-ONE-HALF-INCH GALVANIZED PIPE THREADED
AT BOTH ENDS BUT NO END CAPS, ENDS BEING TAPED
OVER WITH BLACK ELECTRICAL TAPE, ONE WESTCLOCK
ALARM CLOCK, WHITE FACE WITH BLACK LETTERS, WITH
WIRES RUNNING FROM BATTERY TO CLOCK TO PIPE.
THIS DEVICE WAS EXAMINED BY THE LOS ANGELES POLICE
DEPARTMENT BOMB SQUAD AND FOUND TO BE A HOAX DEVICE.
THE CONTENTS OF THE PIPE WERE SOME TYPE OF PLASTIC (u)

2

PAGE THREE (LA 89-436) UNCLAS

HARDWOOD PUTTY (u)

ONE 50-POUND BOX OF NINE-MILLIMETER LUGER,
115-GRAIN BULLETS, SHIPPING NUMBER 79, LOT NUMBER
58HR2. (u)

ONE BOX 50 ROUNDS, .38-CALIBER, SMITH AND WESSON,
140-GRAIN, LEAD BULLET, SHIPPING NUMBER 40, LOT NUMBER
33GD01. (u)

ONE COFFEE CAN FILLED WITH MISCELLANEOUS
.12-GAUGE SHOTGUN ROUNDS. (u)

ONE SHOULDER HOLSTER FOR A FOUR- OR SIX-INCH
REVOLVER. (u)

ONE CLIP-ON HOLSTER FOR A FOUR-INCH, .38
REVOLVER (u)

ONE STARTER GUN WITH TWO, 100 EACH, BOXES OF
STARTING PRIMERS. (u)

ONE M-18, GREEN-SMOKE GRENADE. (u)

ONE 6.5-MILLIMETER NORMA RIFLE ROUND. (u)

ONE WEATHERBY 300-MAGNUM ROUND. (u)

ONE BAG CONTAINING APPROXIMATELY 100 MISCELLANEOUS
38 ROUNDS. (u)

3

PAGE FOUR (LA 89-436) UNCLAS

THIS SEARCH WARRANT WAS CONDUCTED ON THE BASIS OF AN EXTORTION AND FRAUD CASE THE DISTRICT ATTORNEY BUREAU OF INVESTIGATION OFFICE, LOS ANGELES COUNTY, HAD BEEN CONDUCTING WITH JAMES WARREN JONES, ALSO KNOWN AS REVEREND JIM JONES, AND JAMES MC ELVANE SUBJECTS. (u)

LOS ANGELES WILL NOTIFY BUREAU AND SAN FRANCISCO IF ANY OTHER PERTINENT ITEMS ARE FOUND AFTER ALL ITEMS HAVE BEEN PROPERLY EXAMINED. (u)

BT

#

4

K.

~~CONFIDENTIAL~~

FBB688

FAGL 00

BRIDGE 03455 270121Z

ACTION ARA-15

27 Nov 78 01 35Z

INFO OCT-01 ISO-00 FBIE-00 JUSE-00 SY-05 DODE-00

CIAE-00 INR-10 NSAE-00 SCS-06 CA-00 SSO-00 INR-00

/041 W

FEDERAL GOVERNMENT

Assoc. Dir.	
Dep. AD Adm.	
Dep. AD I	
Asst. Dir.:	
Adm.	
Crim. Inv.	
Ident.	
Insp.	
Intell.	
Lab.	
Plan. & Insp.	
Rec. Mgmt.	
Tech. Servs.	
Training	
Off. of Cong. & Public Affs.	
Telephone Rm.	
Director's Sec'y	

---AAAAAAAAAAAAAAAAAPOQQQWS 270124Z /73

O P 270022Z NOV 78

FBI
ALL INFORMATION CONTAINED
HEREIN IS UNCLASSIFIED
DATE 9/24/92 BY 98 DIC/indm

FM AMEMBASSY BRIDGETOWN

TO AMEMBASSY PORT OF SPAIN NIACT IMMEDIATE

INFO SECSTATE WASHDC PRIORITY 6800

AMEMBASSY GEORGETOWN PRIORITY

REC-102

894286 - 436

~~CONFIDENTIAL~~ BRIDGETOWN 3455

23 NOV 23 1978

E.O. 11652: GDS

Declass per State let 2/16/2005
UC65179DMH/ST/bpg

TAGS: CASC, OREP (RYAN, LEO), TD, BB

58 NOV 30 1978
SUBJ: PEOPLES TEMPLE MOVEMENT

REF.: A. PORT OF SPAIN 3396 B. PORT OF SPAIN 3398

1. GOVERNMENT OF BARBADOS AGREES TO VISIT AS PROPOSED, HOWEVER, AGENTS WILL HAVE TO SURRENDER THEIR WEAPONS ON ARRIVAL TO CUSTOMS. WEAPONS WILL BE RETURNED ON THEIR DEPARTURE.

2. WHEN ADVISED OF PRESENCE OF PT MEMBERS ON BOARD VESSEL CALLING AT BARBADOS, MINISTER OF EXTERNAL AFFAIRS WHO IS ALSO ATTORNEY GENERAL DECIDED BOTH MEN WOULD BE GIVEN TREATMENT AS UNDESIRABLE ALIENS AND NOT ADMITTED. THIS IS HIS FIRST THINKING AND POSITION MAY CHANGE BY TOMORROW BUT FOR PLANNING, [REDACTED] AND [REDACTED] SHOULD EXPECT TO INTERVIEW ONE OR BOTH PT MEMBERS ABOARD VESSEL PROVIDED CAPTAIN DOES NOT OBJECT.

b6 per FBI
b7C

~~CONFIDENTIAL~~

2

~~CONFIDENTIAL~~

PAGE 02

BRIDGE 0345T 270121Z

3. AS OF 1900 LOCAL, ALBATROSS III HAD NOT BEEN HEARD FROM. VESSELS ARRIVING AFTER 1800 MAY NOT COME ALOGSIDE IN SMALL VESSEL BERTH IN CAREENAGE BUT MUST MOOR IN OFFHORE ANCHORAGE. CUSTOMS AND IMMIGRATION ARE ALERT TO VESSEL'S EXPECTED ARRIVAL AND CONSULAR OFFICER WILL ATTEMPT TO BOARD AT EARLIEST OPPORTUNITY NOVEMBER 27 TO DETERMINE WHETHER INTERVIEWS CAN TAKE PLACE.

4. REQUEST AGENTS' FLIGHT ETA BARBADOS IN ORDER THAT WE CAN MEET AND ASSIST.

ORTIZ

3

NNNNVV FBA142

00 RUEHFB

DE RUEHC #0009 3310629

ZNY CCCCC ZZH

080602Z NOV 78

FBI SECSTATE WASHDC

27 Nov 78 06 41z

RECEIVED
FEDERAL BUREAU
OF INVESTIGATION
COMMUNICATIONS SECTION

FBI
ALL INFORMATION CONTAINED
HEREIN IS UNCLASSIFIED
DATE 9/29/92 BY 1048 DKM/ldm

Assoc. Dir.	
Dep. AD Adm.	
Dep. AD Inv.	
Asst. Dir.:	
Adm. Serv.	
Crim. Inv.	<i>M/ken</i>
Ident.	
Int'l.	
Laboratory	
Legal Coun.	
Plan. & Insp.	
Rec. Mgmt.	
Tech. Serv.	
Training	
Public Affs. Off.	
Telephone Rm.	
Director's Sec'y	

(Handwritten initials)



TO RUESON/AMEMBASSY GEORGETOWN IMMEDIATE 3897

RUEHZP/AMEMBASSY PANAMA IMMEDIATE 3004

RUESRS/AMEMBASSY CARACAS IMMEDIATE 3714

RUEHSP/AMEMBASSY PORT OF SPAIN IMMEDIATE 0694

FEDERAL GOVERNMENT

b6 per FBI
b7C

RUDTC/AMEMBASSY LONDON IMMEDIATE 4215

RUEHCR/AMEMBASSY PARAMARIBO IMMEDIATE 4586

(Handwritten: RYMLUR)

RUEHFB/ FBI WASHDC IMMEDIATE 0043

RUEBWJA/DEPT OF JUSTICE WASHDC IMMEDIATE

RULPALJ/CINCSOUTHCOM QUARRY HTS CANAL ZONE IMMEDIATE

REC-102

RUCIMAA/CINCMAC SCOTT AFB ILL IMMEDIATE

(Handwritten: 89-4286-437)

RUCJAAA/US REDCOM/RCJ2 MACDILL AFS FLA IMMEDIATE

RUCLHTD/UNCINCARRED FT MCPHERSON GA IMMEDIATE

23 NOV 28 1978

RUCLGFA/CDR 18TH AIRBORNE CORPS FT BRAGG NC IMMEDIATE

RUSNAAA/UNCINCEUR VAIHINGEN GE ATTN: J-2 IMMEDIATE

BT

~~CONFIDENTIAL~~ STATE 300009

E.O. 11652: GDS

Declass per State let 2/16/2005
UC65179DMH/ST/bpg

58 NOV 30 1978
TAGS: CASC, GY

SUBJECT:

SITUATION REPORT: 22-11/26/78 (2400 EST)

REF: STATE 299149

, THE FINAL COUNT OF BODIES REMOVED FROM JONESTOWN AND TRANSPORTED TO DOVER AIR FORCE BASE IS BEING CONFIRMED BUT WILL TOTAL 912 OR 913. PERSONNEL AT DOVER ARE CONTINUING THE SLOW AND DIFFICULT PROCESS OF ATTEMPTING TO IDENTIFY THE VICTIMS. SCS IS COLLATING GUYANA IMMIGRATION FILES WITH PASSPORT APPLICATIONS IN OUR FILES TO PREPARE A NEXT OF KIN LIST. THE MEDICAL RECORDS FROM JONESTOWN ARE SCHEDULED IN DOVER TONIGHT AND SHOULD PROVE HELPFUL IN THE IDENTIFICATION PROCESS. IN A REVERSAL, THE GUYANESE DECIDED NOT TO PERMIT FINGERPRINT CARDS IN OFFICIAL IMMIGRATION FILES TO LEAVE THE COUNTRY. OUR EMBASSY IS MAKING ARRANGEMENTS TO HAVE THE CARDS PHOTOGRAPHED AND THE FILM SENT TO DOVER TO HELP IN THE IDENTIFICATION PROCESS.

2. THE BUREAU OF CONSULAR AFFAIRS HAS PARTICIPATED IN THE DEPARTMENT'S TWENTY-FOUR HOUR MULTI-BUREAU AND MULTI-AGENCY GUYANA TASK FORCE. BETWEEN 10 AND 20 OFFICERS AND STAFF HAVE MANNED NINE TELEPHONE LINES. IT IS CONSERVATIVELY ESTIMATED THAT THEY HAVE HANDLED 4,000 TELEPHONE CALLS FROM RELATIVES AND FRIENDS OF THE VICTIMS AND THE GENERAL

PUBLIC. AS PART OF THE EFFORT TO IDENTIFY THE VICTIMS AND INFORM NEXT OF KIN, THE SCS STAFF HAS SENT OVER 1,000 NAMES OF POSSIBLE PEOPLE'S TEMPLE MEMBERS RESIDENT IN GUYANA TO THE EMBASSY ON THE BASIS OF INFORMATION TELEPHONED INTO THE DEPARTMENT. THE SCS JOB HAS REALLY JUST BEGUN; THEY WILL HAVE A MAJOR ROLE IN OBTAINING INFORMATION TO ASSIST IN IDENTIFYING BODIES AND NOTIFYING NEXT OF KIN.

3. THERE IS STILL NO DEFINITE WORD ON WHEN THE GUYANESE WILL RELEASE SURVIVORS. THE EMBASSY MAY LEARN SOMETHING ON MONDAY. PREPARATIONS TO RECEIVE SURVIVORS AT CHARLESTON AFB ARE WELL ADVANCED, BUT THERE MAY WELL BE PROBLEMS AS THE LARGE PRESS CONTINGENT SEES THIS AS A MAJOR MEDIA EVENT, WHILE MANY OF THE SURVIVORS STILL FEAR FOR THEIR LIVES AND MAY NOT WANT TO BE PHOTOGRAPHED.

4. THE U.S. MILITARY RETROGRADE OPERATIONS CONTINUE. APPROXIMATELY HALF OF THE SIXTEEN MISSIONS SCHEDULED WILL BE COMPLETED BY MORNING. REDUCED HELICOPTER SUPPORT FOR THE EMBASSY WILL BE RETAINED FOR THE TIME BEING. TWO EXTENDED RANGE HUEYS ARE BEING SENT TO GUYANA TO REPLACE THE H-3'S FOR THIS PURPOSE. THE AIR FORCE IS ALSO MAKING CONTINGENCY PLANS TO PICK UP SURVIVORS AND FERRY THEM TO THE U.S. ON TWENTY-FOUR HOUR NOTICE.

5. AMBASSADOR BURKE HAS AN APPOINTMENT TO MEET WITH
PRIME MINISTER BURNHAM AT HIS COUNTRY PLACE AT 00 HOURS
EST TIME MONDAY TO DISCUSS THE ISSUE OF FBI PRESENCE
AND RELATED MATTERS.

6. WE ARE STILL CONSULTING WITH THE EMBASSY ON THE
RETENTION OF LOCAL LEGAL COUNSEL FOR THE USG IN CONNECTION
WITH EVENTS IN JONESTOWN. IN ADDITION, A MEMBER OF THE
DEPARTMENT'S LEGAL OFFICE WILL ARRIVE IN GEORGETOWN NO
LATER THAN TUESDAY EVENING TO ASSIST THE EMBASSY.

7. IN RESPONSE TO PRESS INQUIRIES WE HAVE ASKED THE
EMBASSY TO VERIFY INFORMATION PASSED TO US LAST WEEK TO
THE EFFECT THAT GUYANESE AUTHORITIES INTENDED TO CONDUCT
SAMPLE AUTOPSIES IN JONESTOWN.

8. WITH THE COMPLETION OF THE REMOVAL OF THE BODIES FROM
GUYANA AND THE RAPID PHASE DOWN OF MILITARY OPERATIONS,
SITUATION REPORTS WILL BE PREPARED ONLY ONCE A DAY. VANCE

BT

#0009

SF0819 3300144Z

OO HQ

DE SF 002

Ø 270142Z NOV

FM SAN FRANCISCO (89-250) (P) (SQ. 10)

TO DIRECTOR (89-4286) IMMEDIATE

BT

UNCLAS

ATTENTION: CID COMMAND POST

RYMUR

27 Nov 78 02 01z

RECEIVED
FEDERAL BUREAU
OF INVESTIGATION
COMMUNICATIONS SECTION

Assoc. Dir.	_____
Dep. AD Adm.	_____
Dep. AD Inv.	_____
Asst. Dir.:	_____
Adm. Serv.	_____
Crim. Inv.	_____
Ident.	_____
Intell.	_____
Laboratory	_____
Legal Coun.	_____
Plan. & Insp.	_____
Rec. Ment.	_____
Tech. Servs.	_____
Training	_____
Public Affs. Off.	_____
Telephone Rm.	_____
Director's Sec'y	_____

ALL INFORMATION CONTAINED
HEREIN IS UNCLASSIFIED
DATE 9/24/96 BY 1046 DMH/MLH

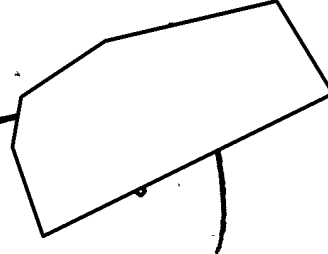

b6
b7C

SAN FRANCISCO DAILY SUMMARY (U)

BEVERLY AND HOWARD OLIVER, VICTIMS OF GUYANA SHOOTING, WILL ARRIVE AT TRAVIS AIR FORCE BASE, CALIFORNIA, AT 6:05 PM, ON NOVEMBER 26, 1978, VIA USAF MEDIVAC, FLIGHT NUMBER 1614. OLIVERS WILL BE TRANSPORTED FROM TRAVIS AIR FORCE BASE TO MT. ZION HOSPITAL, SF, VIA KING AMERICAN AMBULANCE SERVICE. MAJOR JACK SHELTON, COP, TRAVIS AIR FORCE BASE, COORDINATING SECURITY WITH CALIFORNIA HIGHWAY PATROL (CHP) AND SAN FRANCISCO POLICE DEPARTMENT (SFPD). CHP ADVISED THIS OFFICE THAT THEY WILL ESCORT THE



REC-102

89-4286 - 438

58 NOV 30 1978

PAGE TWO SF 89-250 UNCLAS

AMBULANCE AND THE OLIVERS TO MT. ZION HOSPITAL. (u)

COLUMBIA OFFICE FURNISHED COPY OF SAN FRANCISCO
TELETYPE, DATED NOVEMBER 25, 1978, TO BUREAU, WHICH SETS FORTH
ANALYSIS OF CONSPIRACY AND COPIES OF FD-302S RE INTERVIEWS WITH
DEBORAH LAYTON BLAKEY, [REDACTED]
AND COPY OF AFFIDAVIT, DATED JUNE 15, 1978, BY DEBORAH LAYTON
BLAKEY ALSO FURNISHED. (u)

b6
b7c

CHARLES GARRY, ATTORNEY, SAN FRANCISCO, MADE
AVAILABLE TODAY, A LIST OF PEOPLE'S TEMPLE (PT) MEMBERS THAT
REPORTEDLY TRAVELED TO GUYANA. (u)

SUMMARY OF PT AND ITS DEVELOPMENT FURNISHED BUREAU
FOR RELAY TO LEGAT AT GEORGETOWN, GUYANA. (u)

"ARMED AND DANGEROUS. SUICIDAL TENDENCIES" (u)

BT

2

✓

CONFIDENTIAL 48 48 z FBB724

Assoc. Dir.	
Dep. AD Adm.	
Dep. AD Inv.	
Asst. Dir.:	
Adm. Serv.	
Crim. Inv.	
Ident.	
Intell.	
Laboratory	
Legal Coun.	
Plan. & Insp.	
Rec. Mgnt.	
Tech. Servs.	
Training	
Public Affs. Off.	
Telephone Rm.	
Director's Sec'y	

PAGE 01

GEORGE 0367 DE INVESTIGATION COMMUNICATIONS SECTION

ACTION L-03

COMMUNICATIONS SECTION

INVO OCT-01 ARA-11 ISO-00 SCS-06 CA-01 SSO-00 H-01

SS-15 JUSE-00 FBIE-00 /038 W

-----AAAAAPOUEQR 271836Z /44

O 271835Z NOV 78

FM AMEMBASSY GEORGETOWN

TO SECSTATE WASHDC NIACT IMMEDIATE 8234

~~CONFIDENTIAL~~ GEORGETOWN 3963

E.O. 11652: GDS

TAGS: CASC, OREP (RYAN) GY

SUBJECT: ENGAGEMENT OF LOCAL LEGAL COUNSEL

FEDERAL GOVERNMENT

FOR ALL INFORMATION CONTAINED HEREIN IS UNCLASSIFIED DATE 9/24/92 BY 1096DKM/MLM

Handwritten signature and initials

b6 per FBI
b7C

REF: GEORGETOWN 3953 AND PREVIOUS REC-102

89-4286-439

ATTORNEY [] CALLED AMBASSADOR AT 1:08 P.M. NOV. 27

TO INFORM HIM THAT HIS BROTHER SIR LIONEL LUCKHOO HAD DECIDED

NOT REPEAT NOT TO UNDERTAKE THE DEFENSE OF LARRY LAYTON

NOV 28 1978

[] STATED THAT HIS DECISION WAS UNRELATED TO ANY POSSIBILITY

THAT HE, LLOYD LUCKHOO, MIGHT BE ENGAGED ON BEHALF OF THE USG.

BURKED

58 DEC 1 1978

Declassified per STATE letter 2/16/2005 UC65179DMH/ST/bpg

Handwritten signature

NNNVV FBA307

OO RUEHFB

DE RUEKJCS #2835 3312100

ZNY CCCCC

O 271744Z NOV 78 ZDS

FM JCS WASHINGTON DC//J3//

TO RULPALJ/USCINCSO QUARRY HEIGHTS CZ

RUCIMAA/CINCMAC SCOTT AFB IL

RUCJAAA/USCINCPAC MACDILL AFB FL

INFO ZEN/SECDEF WASHINGTON DC

RUSNAAA/USCINCEUR VAIHINGEN GE

RUHQHQA/CINCPAC HONOLULU HI

RUWRNLB/CINCPAC PETERSON AFB CO

RUCIPBA/USCINCPAC LANGLEY AFB VA

RUEHC/SECSTATE WASHINGTON DC

RUEADWW/WHITE HOUSE WASHINGTON DC//SITROOM//

RUWIEKA/CINCSAC OFFUTT AFB NE

RUETIAA/DIRNSA FT GEORGE G MEADE MD

RUESON/AMEMB GEORGETOWN GY

RUEBHEA/21AF OC MCGUIRE AFB NJ//CAT//

RUCLSLA/437MAW CHARLESTON AFB SC

RUCBMA/39ARRW EGLIN AFB FL

RUCBSAA/CINCLANT NORFOLK VA

RUWTMAB/AFMPC RANDOLPH AFB TX//MPCCM//

27 NOV 78 21 15z

COMPARATIONS SECTION

ALL INFORMATION CONTAINED
HEREIN IS UNCLASSIFIED
DATE 9/25/92 BY 1048 OXM/...

Assoc. Dir.	
Dep. AD Adm.	
Dep. AD Inv.	
Asst. Dir.:	
Adm. Serv.	
Crim. Inv.	
Ideat.	
Intell.	
Laboratory	
Legal Coun.	
Plan. & Insp.	
Rec. Mgnt.	
Tech. Servs.	
Training	
Public Affs. Off.	
Telephone Rm.	
Director's Sec'y	

FEDERAL

Leo Ryan

(Handwritten initials)

REC-102

89-4286-440

Declassified per DOD letter 7/21/2005
65179DMH/ST/bpg

211
58 NOV 30 1978

RUEBEJA/436 ABG DOVER AFB DE//SVM//

RUEBEJA/436MAW DOVER AFB DE

RUCLHTD/USCINCARRED FT MCPHERSON GA

RUWIBGR/ARRS SCOTT AFB IL//CG//

RUEADWD/CSA WASHINGTON DC

RUENAAA/CNO WASHINGTON DC

RUEAHQA/CSAF WASHINGTON DC

RUEACMC/CMC WASHINGTON DC

RUEBJGA/COMDT COGARD WASHINGTON DC

RUEHFB/F B I WASHINGTON DC//DIR//

BT

~~CONFIDENTIAL~~ 4885

SUBJ: JCS SITREP 008/271700Z NOV 78 (FINAL)

(U) 1. ~~XX~~ SITUATION:

A. LAST FLIGHT CARRYING HUMAN REMAINS ARRIVED DOVER AFB 252355Z NOV 78 BRINGING TOTAL NUMBER OF BODIES RECOVERED FROM JONESTOWN TO 912.

B. EIGHTY SURVIVORS HAVE BEEN IDENTIFIED IN GEORGETOWN: ONE HAS RETURNED TO US ON OWN: 47 DETAINED BY GOVERNMENT OF GUYANA (GOG)

2

AS UNFRIENDLY/POSSIBLY HOSTILE; 28 UNDER GOG HOUSE ARREST AS NON-MILITANTS; AND 4 IMPRISONED BY GOG AT GEORGETOWN. GOG HAS NOT INDICATED WHEN SURVIVORS WILL BE RELEASED.

2. ~~(C)~~ FRIENDLY OPERATIONS.

(U)

A. AS OF 271200Z NOV 78, 39 US MILITARY PERSONNEL REMAINED IN GEORGETOWN. JTF GUYANA WAS DISESTABLISHED AT 271145Z NOV 78 WHEN JTF COMMANDER RETURNED TO CANAL ZONE. ONLY US FORCES REMAINING IN GUYANA WILL BE 2 UH-1 HELICOPTERS AND CREWS SUPPORTING AMEMB GEORGETOWN. ADDITIONALLY, 3 HH-53S WILL REDEPLOY 281100Z NOV 78.

B. EXTENSIVE DAYLIGHT SEARCH OF JONESTOWN FAILED TO FIND ADDITIONAL BODIES OR SURVIVORS.

3. (U) GENERAL INFORMATION. DOD MAY BE TASKED TO AIRLIFT SURVIVORS FROM GEORGETOWN TO CONUS AFTER THEIR RELEASE BY GOG. DOD IS PREPARED TO HAVE AIRCRAFT IN GEORGETOWN 24 HOURS AFTER NOTIFICATION IF MILITARY AIRLIFT IS REQUIRED. GDS 84

BT

#2805

Assoc. Dir.	
Dep. AD Adm.	
Dep. AD Inv.	
Asst. Dir.:	
Adm. Serv.	
Crim. Inv.	
Ident.	
Intell.	
Laboratory	
Legal Coun.	
Plan. & Insp.	
Rec. Mgnt.	
Tech. Servs.	
Training	
Public Affs. Off.	
Telephone Rm.	
Director's Sec'y	

NK0007 3312137

00 HQ SF

DE NK 007

77 Nov 78 21 47.2

RECEIVED
FEDERAL BUREAU
OF INVESTIGATION
COMMUNICATIONS SECTION

0 272137Z NOV 78

FM NEWARK (89-147) (P) (C-1)

TO DIRECTOR (IMMEDIATE)

SAN FRANCISCO (IMMEDIATE)

ALL INFORMATION CONTAINED
HEREIN IS UNCLASSIFIED
DATE 9/27/92 BY 1080XEL/udm

BT

UNCLAS
RYMUR

RE BUREAU TELETYPE, NOVEMBER 22, 1978, AND TELEPHONE CALL
TO SA DON HALE, SAN FRANCISCO, NOVEMBER 27, 1978. (u)

ON NOVEMBER 27, 1978, [REDACTED]

SCOTCH PLAINS, NEW JERSEY, ADVISED THAT HE HAS MONITORED
HAM RADIO TRANSMISSIONS FROM GUYANA, SOUTH AMERICA. TWO
CALL SIGNS UTILIZED WERE: WB6-MNH/8R1 BELONGING TO PAULA
J. ADAMS, 41 BENNIS STREET, LAMAHA GARDENS, GREATER

GEORGETOWN, GUYANA, UNITED STATES ADDRESS OF 1664 PAGE
STREET, SAN FRANCISCO, CA.; WB6-MID/8R1 BELONGING TO

ALBERT TOUCHETTE, PORT KAITUMA, NORTHWEST DISTRICT, GUYANA,
UNITED STATES ADDRESS OF 3747 ROAD B, REDWOOD VALLEY, CA. (u)

[REDACTED] RECORDED SIX TRANSMISSIONS HE BELIEVES ORIGINATED
IN GUYANA IN WHICH A FEMALE APPEARS TO BE SPEAKING IN A CODE.
THE FEMALE SPOKE OF DESTROYING SOMETHING BY TAKING IT TO (u)

58 NOV 30 1978

b6
b7c

REC-102 89-4286-441

PAGE TWO, NEWARK 89-147, UNCRLAS

A LOCAL DUMP. (u)

NEWARK WILL FURNISH SAN FRANCISCO WITH A TRANSCRIPT
OF THE TAPES. (u)

ARMED AND DANGEROUS, SUICRIDAL TENDENCIES. (u)

BT

#

2

LA0002 3312107

00 HQ SF

DE LA

0 272107Z NOV 78

FM LOS ANGELES (89-436) (P) (3)

TO DIRECTOR - IMMEDIATE

SA FRANCISCO (89-250) IMMEDIATE (SF VIA FBIHQ)

BT

27 NOV 78 21 3/12
RECEIVED
FEDERAL BUREAU OF INVESTIGATION
COMMUNICATIONS SECTION

Assoc. Dir.	
Dep. AD Adm.	
Dep. AD Inv.	
Asst. Dir.:	
Adm. Serv.	
Crim. Inv.	
Ident.	
Intell.	
Laboratory	
Legal Coun.	
Plan. & Insp.	
Rec. Mgnt.	
Tech. Servs.	
Training	
Public Affs. Off.	
Telephone Rm.	
Director's Sec'y	

ALL INFORMATION CONTAINED
HEREIN IS UNCLASSIFIED
DATE 9/27/92 BY [signature]

UNCLAS
RYMUR, OO: SAN FRANCISCO.

RE LOS ANGELES TELETYPE TO DIRECTOR AND SAN FRANCISCO,
NOVEMBER 22, 1978. (u)

ON NOVEMBER 27, 1978, [redacted] RESIDING AT
[redacted] LOS ANGELES, CALIFORNIA, TELEPHONE
NUMBER [redacted], ADVISED THAT IN ADDITION TO HER
MOTHER, LEÑA MAE BENTON BEING A MEMBER OF THE PEOPLE'S
TEMPLE (PT), THE FOLLOWING RELATIVES WERE ALSO MEMBERS OF

THE PT: ROBERT AND OFELIA JACOBS, LAST KNOWN ADDRESS

[redacted] SAN JOSE, CALIFORNIA, [redacted]

TELEPHONE NUMBER [redacted] BARBARA JEAN DOUGLAS, NEE

JACOBS (DAUGHTER OF ROBERT AND OFELIA JACOBS), [redacted]

[redacted] SAN JOSE, CALIFORNIA, TELEPHONE (u)

[Handwritten mark]

442

REC-102 89-4286

b6
b7c

TELETYPED TO:

SF 2/11
58 NOV 20 1978

PAGE TWO (LA 89-436) UNCLAS

NUMBER [REDACTED] CHARLES JACOBS (SON OF ROBERT AND OFELIA JACOBS), [REDACTED] SAN JOSE, CALIFORNIA, TELEPHONE NUMBER [REDACTED] LIEUTENANT BROWN, AN UNCLE OF [REDACTED] RESIDING AT [REDACTED] LOS ANGELES, CALIFORNIA, TELEPHONE NUMBER [REDACTED]

[REDACTED] FURTHER ADVISED THAT MRS. MOORE, RESIDING AT [REDACTED] LOS ANGELES, TELEPHONE NUMBER [REDACTED]

WAS ALSO A MEMBER OF THE PT (u)

MRS. [REDACTED] FURTHER ADVISED THAT TO HER KNOWLEDGE HER MOTHER, LENA MAE BENTON, WAS THE ONLY ONE FROM HER FAMILY TO GO TO GUYANA. [REDACTED] FURTHER ADVISED THAT SHE WAS NOT A MEMBER OF PT BUT HAD ATTENDED TWO OR THREE MEETINGS. MRS. [REDACTED] FURTHER STATED THAT PRIOR TO HER MOTHER DEPARTING FOR GUYANA SHE HAD SOLD ALL OF HER MATERIAL POSSESSIONS AND DISCARDED ALL OF HER IDENTIFICATION ON INSTRUCTIONS FROM THE REVEREND JIM JONES. MRS.

[REDACTED] STATED THAT SHE COULD NOT PROVIDE ANY INFORMATION LEADING TO ANY WEAPONS SHIPMENT TO GUYANA, FIREARMS TRAINING, OR ANY CASHING OF WEAPONS OR MONEY. SHE HAD (u)

b6
b7c

PAGE THREE (LA 89-436) UNCLAS

NEVER HEARD OF PT MEMBERS PLANNING TO HARM PUBLIC OFFICIALS OR PRESENT OR FORMER PT MEMBERS. SHE FURTHER HAS NO INFORMATION REGARDING ANY CONTINGENCY PLANS ESPOUSED BY JONES AGAINST PERSONS ATTEMPTING TO ARREST OR CAPTURE HIM. MRS. [REDACTED] FURTHER ADVISED THAT SHE HAD NO KNOWLEDGE OF ANY HIT MEN USED BY THE PT (u)

^N SAC SAN FRANCISCO AT SAN JOSE: (1) ATTEMPT TO LOCATE AND INTERVIEW OFELIA AND ROBERT JACOBS, [REDACTED]

[REDACTED] TELEPHONE NUMBER [REDACTED] (u)

(2) ATTEMPT TO LOCATE AND INTERVIEW BARBARA JEAN DOUGLAS, NEE JACOBS, [REDACTED]

TELEPHONE NUMBER [REDACTED] (u)

(3) ATTEMPT TO LOCATE AND INTERVIEW CHARLES JACOBS,

[REDACTED] TELEPHONE NUMBER [REDACTED]

IN VIEW OF THE SHOOTING OF CONGRESSMAN RYAN AND THE REPORTED RESULTING MASS SUICIDES, AS WELL AS THREATS WHICH HAVE BEEN MADE AGAINST GOVERNMENT OFFICIALS, CHURCH MEMBERS CONTACTED IN THIS CASE SHOULD BE CONSIDERED ARMED AND EXTREMELY DANGEROUS WITH SUICIDAL TENDENCIES. (u)

BT

b6
b7c

PH0001 331 2035Z

PP HQ SF LA MM JK KC MI

DE PH

P 272035Z NOV 78

FM PHILADELPHIA (89-276) (SQ 9) (P)

TO DIRECTOR (89-4286) PRIORITY

SAN FRANCISCO (89-250) PRIORITY

LOS ANGELES PRIORITY

MIAMI PRIORITY

JACKSONVILLE PRIORITY

KANSAS CITY PRIORITY

MILWAUKEE (89-120) ROUTINE (INFO.)

BT

UNCLAS
RYMUR.

RE BUREAU TELETYPE TO ALL OFFICES, NOVEMBER 22, 1978, AND
MILWAUKEE TELETYPE TO BUREAU, NOVEMBER 24, 1978. (h)

FOR INFORMATION OF JACKSONVILLE AND KANSAS CITY, THE
BUREAU IS ATTEMPTING TO IDENTIFY AND INTERVIEW ANY HAM RADIO
OPERATORS WHO HAVE BEEN IN RADIO CONTACT WITH GEORGETOWN AND
JONESTOWN, GUYANA AS IT PERTAINS TO RYMUR. (h)

23 NOV 28 1978

Assoc. Dir.	_____
Dep. AD Adm.	_____
Dep. AD Inv.	_____
Asst. Dir.:	_____
Adm. Serv.	_____
Crim. Inv.	AA
Ident.	_____
Intell.	_____
Laboratory	_____
Legal Coun.	_____
Plan. & Insp.	_____
Rec. Mgnt.	_____
Tech. Servs.	_____
Training	_____
Public Affs. Off.	_____
Telephone Rm.	_____
Director's Sec'y	_____

7-7 Nov 78 20 49z
RECEIVED
FEDERAL BUREAU
OF INVESTIGATION
COMMUNICATIONS SECTION

ALL INFORMATION CONTAINED
HEREIN IS UNCLASSIFIED
DATE 9/25/94 BY [signature]

(h)

58 NOV 30 1978

REC-102 89-4286-443

Xp

PAGE TWO, PH 89-276, UNCLAS.

MILWAUKEE DIVISION INFORMS US THERE IS A WORLDWIDE NETWORK OF MEDICAL AMATEUR RADIO COUNCIL MEMBERS (MARCO)

AND ACCORDING TO THE MIDWEST NET CONTROL, MILWAUKEE, WISC. ~~(u)~~ MARCO PROVIDES EMERGENCY MEDICAL SERVICES THROUGH CONSULTATION VIA AMATEUR RADIO. MARCO STATIONS KNOWN TO MILWAUKEE THAT HAVE BEEN IN CONTACT WITH THE PEOPLES TEMPLE IN GUYANA HAVE BEEN FURTHER IDENTIFIED THROUGH THE FEDERAL COMMUNICATIONS CENTER, AMATEUR RADIO LICENSING STATION, GETTYSBURG, PA., AS FOLLOWS: (u)

STATION [REDACTED] ASSIGNED TO [REDACTED]
[REDACTED] SAN JOSE, CALIFORNIA, DATE OF BIRTH: [REDACTED] (u)

STATION [REDACTED], ASSIGNED TO [REDACTED]
[REDACTED] VAN NUYS, CALIFORNIA, DATE OF BIRTH:
[REDACTED] (u)

STATION [REDACTED] ASSIGNED TO [REDACTED]
POST OFFICE BOX [REDACTED] SAN FRANCISCO, CALIFORNIA, DATE OF BIRTH:

[REDACTED] STATION LOCATION, [REDACTED] SAN FRANCISCO, CALIFORNIA. (u)

STATION [REDACTED] ASSIGNED TO [REDACTED]
[REDACTED] TALLAHASSEE, FLORIDA, DATE OF BIRTH: (u)

b6
b7c

PAGE THREE, IH 89-276, UNCLAS

[REDACTED] STATION LOCATION: [REDACTED] RICHARD GEBUR
AIR FORCE BASE, MISSOURI (u)

RECEIVING OFFICES ARE TO CONTACT THESE HAM RADIO
OPERATORS WITHIN THEIR RESPECTIVE DIVISIONS, AND INTERVIEW
REGARDING THEIR INVOL

VEMENT EITHER PROFESSIONALLY OR OTHERWISE
WITH THE PEOPLES TEMPLE SECT IN GUYANA. (u)

MIAMI NOTE ADDITIONAL ADDRESSES FOR [REDACTED] AND
KANSAS CITY AND JACKSONVILLE SHOULD COORDINATE TOGETHER WITH
MIAMI IN EFFORTS TO LOCATE [REDACTED] (u)

ARMED AND DANGEROUS. SUICIDAL TENDENCIES. (u)

BT

b6
b7c

NK0009 3312329

OO HI SF

DE NK 009

O 272329Z NOV 78

27 Nov 78 23 :27z

FM NEWARK (89-147) (P) (C1)

RECEIVED
FEDERAL BUREAU
OF INVESTIGATION
COMMUNICATIONS SECTION

DIRECTOR, FBI
SAN FRANCISCO

IMMEDIATE
IMMEDIATE

ALL INFORMATION CONTAINED
HEREIN IS UNCLASSIFIED
DATE 9/25/92 BY 1046 DLM/ldh

Assoc. Dir.	_____
Dep. AD Adm.	_____
Dep. AD Inv.	_____
Asst. Dir.:	_____
Adm. Serv.	_____
Crim. Inv.	_____
Ident.	_____
Intell.	_____
Laboratory	_____
Legal Coun.	_____
Plan. & Insp.	_____
Rec. Mgnt.	_____
Tech. Servs.	_____
Training	_____
Public Affs. Off.	_____
Telephone Rm.	_____
Director's Sec'y	_____

UNCLAS

RYMUR

RE NK TELCAL TO SF, NOVEMBER 27, 1978; u

BU TEL TO ALL OFFICES, NOVEMBER 22, 1978 rw

ON NOVEMBER 27, 1978, [REDACTED]

LINCOLN PARK, NEW JERSEY, TELEPHONE [REDACTED] ADVISED

THAT ON MAY 1, 1978, HE PATCHED A RADIO-TELEPHONE CALL

FROM MARGARET LNU, JONESTOWN, GUYANA, SOUTH AMERICA, WHO

WAS UTILIZING RADIO CALL SIGN WB6MID/8R3. [REDACTED] ADVISED

HE PATCHED THIS RADIO CALL THROUGH TO TELEPHONE NUMBER

[REDACTED]

HE ALSO ADVISED THAT THE PERSON WHO

ANSWERED THE PHONE IDENTIFIED HERSELF AS "LIL" OR "LILLIAN"

AND THAT THE CALL LASTED FOR TEN MINUTES. (u) REC-120: 89-4286

SAN FRANCISCO WILL IDENTIFY TELEPHONE SUBSCRIBER AND

CONDUCT APPROPRIATE INVESTIGATION. (u)

ARMED AND DANGEROUS. SUICIDAL TENDANCIES. (u)

BT

Handwritten circled mark

b6
b7c

444
23 NOV 28 1978

Handwritten signature

58 NOV 30 1978

TP0006 3312249

OO HQ SF IP

DE TP

O 272245Z NOV 78

FM TAMPA (89-79) (P)

TO DIRECTOR (89-4286) IMMEDIATE

SAN FRANCISCO (89-250) IMMEDIATE

INDIANAPOLIS IMMEDIATE

BT

UNCLAS

RYMUR, AFO (A).

27 Nov 78 22 56z

RECEIVED
FEDERAL BUREAU
OF INVESTIGATION
COMMUNICATIONS SECTION

Assoc. Dir.	_____
Dep. AD Adm.	_____
Dep. AD Inv.	_____
Asst. Dir.:	_____
Adm. Serv.	_____
Crim. Inv.	_____
Ident.	_____
Intell.	_____
Laboratory	_____
Legal Coun.	_____
Plan. & Insp.	_____
Rec. Mgnt.	_____
Tech. Servs.	_____
Training	_____
Public Affs. Off.	_____
Telephone Rm.	_____
Director's Sec'y	_____

ALL INFORMATION CONTAINED
HEREIN IS UNCLASSIFIED
DATE 9/25/92 BY 1049 DCM/ADM

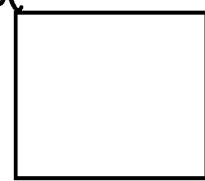

b6
b7c

RE TAMPA TELEPHONE CALL TO INDIANAPOLIS AND SAN FRANCISCO, NOVEMBER 27, 1978; SAN FRANCISCO TELETYPE TO BUREAU, NOVEMBER 22, 1978 (u)

(Handwritten initials)

ON NOVEMBER 27, 1978, [REDACTED] WAS REINTERVIEWED AND FURNISHED THE FOLLOWING ADDITIONAL INFORMATION: (u)

DURING THE LATE 1950'S AND/OR EARLY 1960'S, WHEN HE SERVED AS A MEMBER OF THE PEOPLES' TEMPLE (PT), "COUNCIL OF ELDERS" IN INDIANAPOLIS, IND., IT WAS NOT CALLED THE "PLANNING COMMISSION"; HOWEVER, CONSISTED OF 14 MEMBERS WHOSE PURPOSE, ASIDE FROM BEING A RUBBER STAMP FOR JIM JONES, WAS AS A POLICY (u)

89-4286-445

REC-126

NOV 28

(Handwritten initials)

58 DEC 1 1978

PAGE TWO TP 89-79 UNCLAS

OR PLANNING GROUP. OF THE 14 MEMBERS, THERE WERE 4 WHO WERE PARTICULARLY CLOSE TO JIM JONES, AND WHO, WITH JONES, WOULD HOLD SEPARATE MEETINGS REGARDING POLICY MATTERS AND OTHER MATTERS CONCERNING THE PT. THESE MEETINGS WERE HELD BEFORE ANY COUNCIL OF ELDERS MEETING AND WOULD THEN BE BROUGHT BEFORE THE COUNCIL OF ELDERS AND ALWAYS PASSED. WHILE THESE OTHER MEN FORMED AN "INNER CIRCLE," THEY WERE NOT REFERRED TO BY THAT OR ANY OTHER SPECIFIC TITLE. (u)

THE 4 MEN WERE ARCHIE IAMES, LAST BELIEVED TO BE RUNNING THE PT IN SAN FRANCISCO, CALIF.; RUSSELL WINBERG (PHONETIC), WHO DROPPED OUT OF THE PT WHEN JIM JONES TOOK HIS GROUP FROM INDIANAPOLIS; (FNU) STAHL, WHO IS BELIEVED AMONG THE DEAD IN GUYANA, ALONG WITH JACK BEAMS (PHONETIC), ALSO BELIEVED DEAD. BEAMS OFTEN TALKED ABOUT, AND EXHIBITED, NUMEROUS GUNS OF BOTH HAND HELD AND SHOULDER TYPE. (u)

[REDACTED] ADVISED HE RECALLED WHEN JONES WAS RELIEVED OF HIS CIVIL RIGHTS DIRECTOR POSITION IN INDIANAPOLIS, JONES STOOD BEFORE THE COUNCIL OF ELDERS AND MADE A STATEMENT TO THE EFFECT THAT MAYOR BOSWELL SHOULD BE ELIMINATED INASMUCH AS HE WAS OBVIOUSLY AN ENEMY OF THE PEOPLE (u)

b6
b7c

[REDACTED] FURTHER ADVISED THAT ONE ROSS CASE HAD BEEN CLOSELY ASSOCIATED WITH JONES AND THE PT IN INDIANAPOLIS, BUT ALLEGEDLY BECAME DISENCHANTED AND MOVED TO THE UKIAH, CALIF., AREA BEFORE JONES HAD LEFT INDIANAPOLIS. [REDACTED] STATED HE AND HIS WIFE, [REDACTED]

[REDACTED] TAMPA, FLA., TELEPHONE [REDACTED] ARE SEPARATED, BUT NOT EVERYONE IS AWARE OF THIS. HIS WIFE CONTACTED HIM LAST WEEK AND ADVISED CASE HAD BEEN TRYING TO CONTACT HIM. CASE ALLEGEDLY TOLD [REDACTED] THAT HE BELIEVED HIMSELF TO BE ON SOME KIND OF "HIT LIST" ALONG WITH SOME POLITICIANS. (U)

b6
b7c

[REDACTED] ADVISED THAT [REDACTED] IS CURRENTLY ON A TRIP OF UNKNOWN DURATION TO AN UNKNOWN LOCATION.

[REDACTED] SAID WHEN JONES WAS IN INDIANAPOLIS, HE HAD BRAGGED ABOUT HAVING MANY WEAPONS AT HIS HOME, AND MOST OF HIS CLOSE ASSOCIATES, SUCH AS JACK BEAMS (PHONETIC), HAD WEAPONS AT THEIR HOMES. (U)

[REDACTED] IS DESCRIBED AS WHITE MALE, BORN

[REDACTED]
[REDACTED] SANDY BLOND HAIR, BLUE EYES, [REDACTED]
[REDACTED] (U)

PAGE FOUR TP 89-79 UNCLAS

[REDACTED] PREVIOUSLY FINGERPRINTED FOR MILITARY AND CURRENT
POSITION AS [REDACTED] (u)

INDIANAPOLIS AT INDIANAPOLIS, IND. ADVISE FORMER
MAYOR BOSWELL, IF NOT PREVIOUSLY DECEASED, OF JONES' COMMENTS
AFTER HIS HAVING BEEN RELIEVED AS INDIANAPOLIS CIVIL RIGHTS
DIRECTOR. ATTEMPT TO IDENTIFY AND INTERVIEW RUSSELL WINBERG
(PHONETIC), NOT FURTHER IDENTIFIED. (u)

TAMPA AT TAMPA, FLA. ATTEMPT TO LOCATE [REDACTED]
AND ASCERTAIN MORE SPECIFIC DETAILS REGARDING HER CONVERSATION
WITH ROSS CASE (u)

LEADS AT SAN FRANCISCO ARE BEING LEFT TO THEIR
JUDGMENT. (u)

ARMED AND DANGEROUS. (u)

BT

b6
b7c

4

MI0004 3312203

PP HQ SF

DE MI

P 272203Z NOV 78

FM MILWAUKEE (89-120) P

TO DIRECTOR (89-4286) PRIORITY
SAN FRANCISCO (89-250) PRIORITY

BT

UNCLAS
RYMUR

27 Nov 78 22 11z

RECEIVED
FEDERAL BUREAU
OF INVESTIGATION
COMMUNICATIONS SECTION

ALL INFORMATION CONTAINED
HEREIN IS UNCLASSIFIED
DATE 9/25/92 BY 1046 DPM/whr

Assoc. Dir.	_____
Dep. AD Adm.	_____
Dep. AD Inv.	_____
Asst. Dir.:	_____
Adm. Serv.	_____
Crim. Inv.	_____
Ident.	_____
Intell.	_____
Laboratory	_____
Legal Coun.	_____
Plan. & Insp.	_____
Rec. Mgnt.	_____
Tech. Servs.	_____
Training	_____
Public Affs. Off.	_____
Telephone Rm.	_____
Director's Sec'y	_____



RE MILWAUKEE TELETYPE TO BUREAU NOV. 25, 1978. (u)

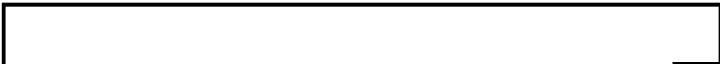

RIVER FALLS, WISCONSIN.

AN AMATEUR RADIO OPERATOR, CALL LETTERS [REDACTED], CONTACTED NOV. 26, 1978, AND ADVISED HE HAS CONTACTED WB6 MID/8R3, JONESTOWN, GUYANA, SOUTH AMERICA, ON THREE DIFFERENT OCCASIONS BY RADIO. [REDACTED]

BECAME AWARE OF WB6 MID/8R3 BY MONITORING THEIR TRAFFIC ON NUMEROUS OCCASIONS, A LOT OF IT BEING MEDICAL TRAFFIC BY A FEMALE AT JONESTOWN WHO APPEARED TO BE A NURSE. (u)

REC-12689-4286-446



FIRST CONTACT WITH WB6 MID/8R3 WAS ON JAN. 30, 1978,

AT 1:05 A.M. FOR APPROXIMATELY 15 MINUTES. HE TALKED WITH ALBERT

TOUCHETTE, WHO INDICATED HE WAS A MISSIONARY WITH A CHRISTIAN CHURCH.

AFTER [REDACTED] TOLD ALBERT HE WAS AN AGRONOMIST, ALBERT

NOV 28
(u)

58 NOV 30 1978

b6
b7c

PAGE TWO MI 89-120 UNCLAS

TALKED AT LENGTH ABOUT THE AGRICULTURAL PROBLEMS AT JONESTOWN AND THE PROBLEM THEY WERE HAVING WITH GROWING PAPAYAS (u)

[] NEXT CONTACT WITH JONESTOWN WAS ON MARCH 18, 1978, AT 1:20 A.M. WHEN HE TALKED WITH ALBERT TOUCHETTE FOR FIVE MINUTES. THIS WAS ONLY AN EXCHANGE OF QSL (CAN YOU ACKNOWLEDGE RECEIPT).

[] NEXT CONTACT WITH WB6 MID/8R3 WAS ON SEPT. 25, 1978, AND HE TALKED WITH LEE LNU FOR 15 MINUTES. LEE TALKED ABOUT MISSION PROBLEMS AND STATED THAT HE THOUGHT THEY HAD SOLVED THE PAPAYA PROBLEM (u)

ON ONE OCCASION [] ASKED TOUCHETTE IF THEY COULD USE INTERNATIONAL POSTAGE COUPONS AND TOUCHETTE STATED THEY COULD USE GREENBACKS. [] SENT A \$1 CONTRIBUTION AS HE WANTED A QSL CARD FROM JONESTOWN. [] DID RECEIVE TWO QSL CARDS; THE MESSAGE WAS THE SAME ON BOTH. ONE WAS HANDWRITTEN AND ONE TYPED. BOTH CARDS WERE SIGNED BY ALBERT (u)

[] STATED THAT IN RADIO TRAFFIC TOUCHETTE WAS A VERY ARTICULATE INDIVIDUAL. HE ALSO INDICATED NO MENTION WAS EVER MADE OF ANY WEAPONS. THE ONLY THING THAT APPEARED STRANGE TO [] WAS THE FACT THAT JONESTOWN WAS ALWAYS STATING HOW APPRECIATIVE THEY WERE OF THE HELP THEY WERE RECEIVING FROM GUYANA GOVERNMENT (u) ARMED AND DANGEROUS; SUICIDAL TENDENCIES. (u)

BT

b6
b7C

NY0898 3312300

PP HQ

DE NY 0009

R 2 72243Z NOV 78

FM NEW YORK (89-495) 7P) (212)

TO DIRECTOR (89-4286) PRIORITY

BT

27 Nov 78 23 08 Z

FEDERAL BUREAU OF INVESTIGATION COMMUNICATIONS SECTION

Assoc. Dir.	_____
Dep. AD Adm.	_____
Dep. AD Inv.	_____
Asst. Dir.:	_____
Adm. Serv.	_____
Crim. Inv.	_____
Ident.	_____
Intell.	_____
Laboratory	_____
Legal Coun.	_____
Plan. & Insp.	_____
Rec. Mgmt.	_____
Tech. Servs.	_____
Training	_____
Public Affs. Off.	_____
Telephone Rm.	_____
Director's Sec'y	_____

ALL INFORMATION CONTAINED HEREIN IS UNCLASSIFIED DATE 1/25/92 BY 1048 DCM/ndm

UNCLAS RYMUR

ON NOVEMBER 24, 1978, A CONFIDENTIAL MEDIA SOURCE ADVISED NEW YORK OFFICE THE PEOPLE'S TEMPLE OF CHRISTIAN DISCIPLES OF GOD (PT) IS INVOLVED HEAVILY IN DRUG SMUGGLING AND GUN RUNNING, AND THAT THE ALBATROSS, A 65 FOOT TRAWLER BELONGING TO THE PT, WAS USED FOR THIS PURPOSE. US COAST GUARD, MIAMI, FLORIDA, ALLEGEDLY CONFIRMED THIS INFORMATION AND STATED THIS SHIP REGISTERED IN MOBIL, ALABAMA. THE MEDIA SOURCE ADVISED OFFICIALS AT THE UNITED STATES LABOR PARTY (USLOP), NEW YORK, NEW YORK, WOULD CONFIRM THESE CHARGES. (u)

98

ON NOVEMBER 27, 1978, [REDACTED] (PROTECT IDENTITY), [REDACTED] USLP, NEW YORK CITY,

REC-126 89-4286-447

b6 b7c

0-73to SP4 EO 112758 kmr/bm

23 NOV 28 1978

10

58 NOV 30 1978

PAGE TWO

ELEPHONE NUMBER [REDACTED] VOLUNTARILY FURNISHED THE
FOLLOWING INFORMATION (U)

USLP HAS BEEN "INVESTIGATING" PT SINCE THE ASSASSINA-
TION OF CONGRESSMAN RYAN. USLP AFRAID USLP OFFICIALS AND
LYNDON LA ROCHE IN PARTICULAR ARE TARGETS OF PT'S "HIT LIST".
USLP HAS WORLDWIDE SOURCES OF INFORMATION AND ALTHOUGH USLP
HAS NO SPECIFICS TO DATE, INFORMATION HAS BEEN RECEIVED
THAT PT INVOLVED IN GUN RUNNING AND DRUG SMUGGLING AND USING
PT SHIPS FOR THIS PURPOSE. PT SUPPOSEDLY ABOUT TO BEGIN
PRODUCTION OF MARIJUANA ON A LARGE SCALE IN GUYANA. THE
LARGE QUANTITY OF GOLD AND DIAMONDS, STANDARD DRUG TRADE
CURRENCY, FOUND AT JONESTOWN SUPPORTS USLP'S INFORMATION (U)
[REDACTED] ADVISED OF THE LIMITED NATURE OF THE FBI'S
CRIMINAL INVESTIGATION OF MEMBERS OF PT. HE WILL ADVISE
NEW YORK OFFICE OF ANY SPECIFICS SUPPORTING THESE ALLEGATIONS.
BUREAU WILL BE KEPT ADVISED (U)

b6
b7C

BT

#

2

MI0005 3312210

PP HQ SF

DE MI

P 272210Z NOV 78

FM MILWAUKEE (89-120) P

TO DIRECTOR (89-4286) PRIORITY

SAN FRANCISCO (89-250) PRIORITY

27 Nov 78 22 15z

RECEIVED
FEDERAL BUREAU
OF INVESTIGATION
COMMUNICATIONS SECTION

Assoc. Dir.	_____
Dep. AD Adm.	_____
Dep. AD Inv.	_____
Asst. Dir.:	_____
Adm. Serv.	_____
Crim. Inv.	_____
Ident.	✓
Intell.	_____
Laboratory	_____
Legal Coun.	_____
Plan. & Insp.	_____
Rec. Mgnt.	_____
Tech. Servs.	_____
Training	_____
Public Affs. Off.	_____
Telephone Rm.	_____
Director's Sec'y	_____

ALL INFORMATION CONTAINED
HEREIN IS UNCLASSIFIED
DATE 9/25/92 BY 1042 DKL/ndm

BT

UNCLAS

RYMUR

ON NOV. 24, 1978, MRS. [REDACTED]

MANITOWOC, WISCONSIN, ADVISED OF THE POSSIBILITY THAT ONE OF THE UNIDENTIFIED INDIVIDUALS WHO COMMITTED SUICIDE IN GUYANA MAY HAVE BEEN HER MISSING DAUGHTER. SHE IDENTIFIED HER MISSING DAUGHTER AS

[REDACTED] A WHITE FEMALE, DOB [REDACTED]. THIS

DAUGHTER HAS BEEN MISSING FOR EIGHT YEARS AND WAS LAST KNOWN TO BE

IN THE FLORIDA AREA. THE DAUGHTER RAN AWAY WITH A [REDACTED]

WHO WORKED AT SUMMERFEST IN MILWAUKEE AT THE TIME. THERE WAS NO

FURTHER DESCRIPTION AVAILABLE ON [REDACTED]. MRS. [REDACTED] ADVISED

THAT HER DAUGHTER'S FINGERPRINTS ARE ON FILE AT WASHINGTON, D.C.,

AS SHE WAS ONCE EMPLOYED BY THE U.S. POST OFFICE (u)

THE ABOVE BEING FURNISHED FOR INFORMATIONAL PURPOSES AND IN (u)

REC-126

89-4286-448

ES NOV 28 1978

(1)

211
58 NOV 30 1978

b6
b7C

PAGE TWO MI 89-120 UNCLAS

ATTEMPT TO IDENTIFY UNKNOWN INDIVIDUALS WHO WERE INVOLVED IN THE
GUYANA INCIDENT (u)

MILWAUKEE INVESTIGATION CONTINUING. (u)

ARMED AND DANGEROUS; SUICIDAL TENDENCIES. (u)

BT

9

cc. Ident

ME0003 3320230Z

28 Nov 78 02 50z

OO HQSF AT

RECEIVED
FEDERAL BUREAU OF INVESTIGATION
COMMUNICATIONS SECTION

DE ME

0 270230Z NOV 78

FM MEMPHIS (89-110) (P)

TO DIRECTOR (89-4286) IMMEDIATE

SAN FRANCISCO (89-250) IMMEDIATE

ATLANTA IMMEDIATE

UNCLAS E F T O

RYMUR. OO: SANFRANCISCO

1648 Dial
ALL INFORMATION CONTAINED
HEREIN IS UNCLASSIFIED
DATE 10/15/80 BY SP1 GSK/108

Assoc. Dir.	_____
Dep. AD Adm.	_____
Dep. AD Inv.	_____
Asst. Dir.:	_____
Adm. Serv.	✓
Crim. Inv.	✓
Ident.	_____
Intell.	_____
Laboratory	_____
Legal Coun.	_____
Plan. & Insp.	_____
Rec. Mgnt.	_____
Tech. Servs.	_____
Training	_____
Public Affs. Off.	_____
Telephone Rm.	_____
Director's Sec'y	_____

RE MEMPHIS TEL TO THE BUREAU, COLUMBIA, AND SAN

FRANCISCO, NOVEMBER 25, 1978. (u)

FOR THE INFORMATION OF ATLANTA, ON THE EVENING OF NOVEMBER 24, 1978, ATTORNEY MARK LANE CONTACTED THE MEMPHIS

OFFICE AND ADVISED HE WAS CONCERNED THAT A INDIVIDUAL BY

THE NAME OF [REDACTED] HAD BEEN ALLEGEDLY RETAINED BY

THE PEOPLES TEMPLE TO BURGLARIZE HIS HOME. LANE SAID HE

HAD INFORMATION FROM A CBS CORRESPONDENT THAT [REDACTED]

HAD BEEN INTERVIEWED BY FBI AGENTS. LANE EXPRESSED DIS-

PLEASURE THAT THE FBI HAD THIS INFORMATION AND DID NOT

ADVISE HIM. INVESTIGATION AT MEMPHIS REVEALED THAT [REDACTED]

[REDACTED], WHITE MALE, DOB [REDACTED]

IS NOV 28 1978

58 NOV 30 1978

b6
b7c

Ⓞ

fy

PAGE TWO ME 89-110 UNCLAS E F T O

CURRENTLY INCARCERATED AT SHELBY COUNTY JAIL, MEMPHIS, TENN., ON A BAD CHECK CHARGE. HE HAS BEEN IN JAIL SINCE OCTOBER 12, 1978. [REDACTED] WAS NOT INTERVIEWED BY THE FBI ON THIS MATTER UNTIL NOVEMBER 25, 1978, SUBSEQUENT TO THE ALLEGATIONS MADE BY LANE. [REDACTED] DENIES ANY CONTACT WITH OR KNOWLEDGE OF LANE, THE PEOPLES TEMPLE, OR REVEREND JIM JONES PRIOR TO INCIDENT IN GUYANA. HIS ONLY KNOWLEDGE HAS COME FROM THE MEDIA. (u)

[REDACTED] STATED HE RECEIVED A CALL IN JAIL FROM HIS MOTHER ON THE EVENING OF NOVEMBER 23, 1978, WHEREIN HIS MOTHER ADVISED HIM A CBS CORRESPONDENT HAD INDICATED

[REDACTED] NAME AND PHONE NUMBER WERE FOUND AMONG THE PERSONAL BELONGINGS OF REV. JONES IN GUYANA. [REDACTED]

FURTHER STATED HE WAS CONTACTED BY A [REDACTED] WHO IDENTIFIED HIMSELF AS A CORRESPONDENT FOR ABC. THIS CONVERSATION WAS BY TELEPHONE AND [REDACTED] HAS BEEN TOLD BY JAIL PERSONNEL THAT O'BRIEN CALLED AND ASKED IF THEY HAD

A [REDACTED] SINCE THAT TIME, [REDACTED] FROM THE CBS AFFILIATE AT MEMPHIS HAS ALSO INDICATED THAT [REDACTED] NAME WAS FOUND AMONG

b6
b7c

(u)

PAGE THREE ME 89-110 UNCLAS E F T O

THE BELONGINGS OF REV. JONES. [REDACTED] WAS UNABLE TO SHED ANY LIGHT ON HOW HIS NAME WAS FOUND IN THE POSSESSION OF REV. JONES BUT DOES RECALL APPROXIMATELY TWO WEEKS AGO, A YOUNG FEMALE CALLED THE JAIL AND IDENTIFIED HERSELF TO JAIL PERSONNEL AS BEING A REPRESENTATIVE OF THE DEPARTMENT OF HUMAN RESOURCES. [REDACTED] SPOKE TO THIS FEMALE ON THE TELEPHONE BUT DURING HIS CONVERSATION WITH HER, SHE DID NOT IDENTIFY HERSELF AS BEING FROM THE DEPARTMENT OF HUMAN RESOURCES. SHE DID ASK HIM IF HE KNEW A [REDACTED] SHE ALSO ASKED IF HE WOULD BE WILLING TO GO INTO AN ATTORNEY'S OFFICE HERE IN MEMPHIS AND WHETHER HE WOULD BE ABLE TO TAKE PHOTOGRAPHS. ACCORDING TO [REDACTED], HE TOLD TOLD HER THAT HE COULD NOT GO ANYWHERE WHILE HE WAS IN JAIL AND THAT HE WAS NOT GOING TO DISCUSS IT WITH HER UNTIL HE GOT OUT OF JAIL. [REDACTED] SAID HE HAS NO KNOWLEDGE IF THERE IS ANY CONNECTION BETWEEN THIS AND HIS NAME BEING INVOLVED WITH THE PEOPLES TEMPLE BUT VEHEMENTLY DENIES ANY IMPLICATION WITH REV. JONES AND THE PEOPLES TEMPLE. [REDACTED] STATED HE DID KNOW A [REDACTED] WHO WAS A FELLOW INMATE WITH HIM AT FCI, EL RENO, OKLAHOMA. [REDACTED]

b6
b7c

PAGE FOUR ME89-110 UNCLAS E F T O

HAS NOT SEEN [REDACTED] SINCE APPROXIMATELY 1976 AND HAS HAD NO CONTACT WITH HIM SINCE THAT TIME. (u)

[REDACTED] INDICATED HE WAS UNFAMILIAR WITH THE PEOPLES TEMPLE AND REV. JONES UNTIL THE DEATH OF CONGRESSMAN RYAN AND THE MASS SUICIDE WHICH HAS BROUGHT THIS INTO NATIONAL PROMINENCE. (u)

b6
b7C

IN REVIEWING THE INFORMATION AVAILABLE, THE TELEPHONE NUMBER OF [REDACTED] IN MEMPHIS WAS OBVIOUSLY MADE AVAILABLE TO CBS CORRESPONDENT DON BROWN IN ATLANTA, GEORGIA, AS HE INITIATED A CALL TO [REDACTED] MOTHER. [REDACTED] [REDACTED] CHANNEL THREE, ~~MEMPHIS~~ MEMPHIS, ADVISED HE GOT THE INFORMATION FROM BROWN, WHO ALLEGEDLY RECEIVED IT FROM THE FATHER OF A MEMBER OF THE MILITARY FORCE SENT IN AFTER THE MASSACRE. THIS SERVICEMAN, NAME UNKNOWN, FURNISHED THREE NAMES AND THREE PHONE NUMBERS TO HIS FATHER WHICH WERE ALLEGEDLY FOUND IN THE PERSONAL BELONGINGS OF REV. JONES.

ATLANTA, SHOULD IMMEDIATELY LOCATE DON BROWN, CBS, ATLANTA, TO DETERMINE, IF POSSIBLE, THE SOURCE OF HIS INFORMATION. THE THREE NAMES FURNISHED TO BROWN SHOULD BE

(u)

4

PAGE FIVE ME89-110 UNCLAS E F T O

VERIFIED AND CHECKED TO DETERMINE IF ANY WERE KNOWN
MEMBERS OF THE PEOPLES TEMPLE. (u)

BT

5

KC0015 3320038Z

PP-HQ JJK SI

DE KC

P 272348Z NOV 78

KANSAS CITY (89-0)

TO DIRECTOR (89-4286) PRIORITY

JACKSONVILLE PRIORITY

SPRINGFIELD PRIORITY

28 Nov 78 00 46z

RECEIVED
FEDERAL BUREAU
OF INVESTIGATION
COMMUNICATIONS SECTION

Assoc. Dir.	_____
Dep. AD Adm.	_____
Dep. AD Inv.	_____
Asst. Dir.:	_____
Adm. Serv.	_____
Crim. Inv.	<input checked="" type="checkbox"/>
Ident.	_____
Intell.	_____
Laborator.	_____
Legal Coun.	_____
Plan. & Insp.	_____
Rec. Mgnt.	_____
Tech. S. s.	_____
Training	_____
Public Affs. Off.	_____
Telephone Rm.	_____
Director's Sec'y	_____

ALL INFORMATION CONTAINED
HEREIN IS UNCLASSIFIED
DATE 9/28/92 BY 1018 DLM/w



b6
b7c

BT

UNCLAS
RYMUR

RE BUREAU TELETYPE TO ALL OFFICES, NOVEMBER 22, 1978;
MILWAUKEE TELETYPE TO BUREAU, NOVEMBER 24, 1978; PHILADELPHIA
TELETYPE TO BUREAU, NOVEMBER 27, 1978. (u)

9

FOR INFO OF SPRINGFIELD, BUREAU IS ATTEMPTING TO IDENTIFY
AND INTERVIEW ANY HAM RADIO OPERATORS WHO HAVE BEEN IN RADIO
CONTACT WITH GEORGETOWN AND JONESTOWN, GUYANA, AS IT PERTAINS
TO RYMUR. (u)

MILWAUKEE DIVISION ADVISED THERE IS A WORLD-WIDE NETWORK
OF MEDICAL AMATEUR RADIO COUNCIL MEMBERS (MARCO), AND ACCORDING
TO MIDWEST NET CONTROL MILWAUKEE, WISCONSIN, MARCO PROVIDES

450

REC-126

89-4286-14

23 NOV 23 1978

AMS

58 DEC 1 1978

PAGE TWO, KC 89-Ø, UNCLAS

EMERGENCY MEDICAL SERVICES THROUGH CONSULTATION VIA AMATEUR RADIO. MARCO STATIONS KNOWN TO MILWAUKEE THAT HAVE BEEN IN CONTACT WITH THE PEOPLES TEMPLE IN GUYANA HAVE BEEN FURTHER IDENTIFIED THROUGH THE FEDERAL COMMUNICATIONS CENTER, AMATEUR RADIO LICENSING STATION, GETTYSBURG, PENNSYLVANIA, AND INCLUDE THE FOLLOWING: (u)

STATION [REDACTED],

ASSIGNED TO [REDACTED]

[REDACTED] TALLAHASSEE, FLORIDA, BORN [REDACTED]

[REDACTED] STATION LOCATION: [REDACTED]

RICHARDS GEBUR AFB,

MISSOURI. (u)

FOR INFO OF SPRINGFIELD, [REDACTED] IS BASE HOUSING CURRENTLY ASSIGNED TO THE U. S. MARINE CORPS. ALL AIR FORCE PERSONNEL HAVE BEEN TRANSFERRED TO SCOTT AIR FORCE BASE, ILLINOIS. (u)

SPRINGFIELD ASCERTAIN IF ABOVE HAM RADIO STATION IS NOW BEING OPERATED BY [REDACTED] AT SCOTT AIR FORCE BASE. [REDACTED] SHOULD BE INTERVIEWED REGARDING HIS INVOLVEMENT EITHER PROFESSIONALLY OR OTHERWISE WITH THE PEOPLES TEMPLE SECT IN GUYANA. (u)

ARMED AND DANGEROUS; SUICIDAL TENDENCIES. (u)

BT

b6
b7c

2

Assoc. Dir.	_____
Dep. AD Adm.	_____
Dep. AD Inv.	_____
Asst. Dir.:	_____
Adm. Serv.	_____
Crim. Inv.	_____
Ident.	_____
Intell.	_____
Laboratory	_____
Legal Coun.	_____
Plan. & Insp.	_____
Rec. Mgnt.	_____
Tech. Servs.	_____
Training	_____
Public Affs. Off.	_____
Telephone Rm.	_____
Director's Sec'y	_____

IP0008 3310237Z

00 HQ SF CO

DE IP

O 270237Z NOV 78

28 Nov 78 02 50z

RECEIVED
FEDERAL BUREAU
OF INVESTIGATION
COMMUNICATIONS SECTION

FM INDIANAPOLIS (89-181) (P)

TO DIRECTOR (89-4286) IMMEDIATE

SAN FRANCISCO (89-250) IMMEDIATE

COLUMBIA IMMEDIATE

ALL INFORMATION CONTAINED
HEREIN IS UNCLASSIFIED
DATE 9/25/96 BY 1048 DK/ML/and

BT

UNCLAS

RYMUR; 00: SF

ON 11/27/78, MR S. [REDACTED]

INDIANAPOLIS, INDIANA, TX [REDACTED], ADVISED SHE NEVER MET

REVERAND JIMMY JONES, HOWEVER, THE FOLLOWING FAMILY WERE MEMBERS

OF THE PEOPLES TEMPLE (PT): SON, CHARLES EUGENE TOUCHETTE, AKA

CHUCK, WHITE MALE, DOB/ 9-29-30, POB/ INDIANAPOLIS, INDIANA, WHO

IS CURRENTLY BELIEVED TO BE IN TRINADAD; DAUGHTER-IN-LAW, CAROL

JOYCE TOUCHETTE, NEE, SWINNEY, WHITE FEMALE, AGE 45, BELIEVED TO

HAVE DIED IN GUYANA; GRAND SON, MICHAEL JOHN TOUCHETTE, WHITE MALE,

DOB/ 1-11-53, WAS IN GUYANA AT THE TIME, HOWEVER, ACCORDING TO

U.S. STATE DEPARTMENT, SURVIVED; ALBERT ARDELL TOUCHETTE, WHITE MALE

DOB/ 9-13-54, DIED IN GUYANA; MICHELLE ELAINE TOUCHETTE, ²³ NOV 28 1978

WHITE FEMALE, AGE 22, ALSO BELIEVED TO HAVE DIED IN GUYANA;

GRANDDAUGHTER, MICKEY JEAN TOUCHETTE, WHITE FEMALE, (4)

58 NOV 30 1978

b6
b7c

(Handwritten signature)

REC-126 89-4286-451

NOV 28 1978

PAGE TWO IP 89-181 UNCLAS

DOB/ 5-4-51, A FORMER MEMBER OF THE PT, CURRENTLY LIVING IN THE SAN FRANCISCO, CALIFORNIA AREA, CBR AT TX 415-848-1773. (u)

MICKEY JEAN TOUCHETTE WAS A FORMER PERSONAL SECRETARY TO JIMMY JONES AND BECAME DISGUSTED WITH HIS FINANCIAL DEALINGS AND HIS BREAKING UP OF FAMILIES. ACCORDING TO MICKEY JEAN, JONES HAS LARGE SUMS OF MONEY HIDDEN IN CAVES ALL OVER THE STATE OF CALIFORNIA. SHE LEFT THE PT SEVERAL YEARS AGO AND HAS BEEN IN CONSTANT FEAR OF RETALIATION EVER SINCE. (u)

IN ADDITION TO THE ABOVE IMMEDIATE MEMBERS OF THE TOUCHETTE FAMILY, DAUGHTER-IN-LAW CAROL JOYCE TOUCHETTE, NEE SWINNEY, HAS THE FOLLOWING BROTHERS WHO ARE OR WERE ACTIVE IN THE PT. TIMOTHY SWINNEY, BELIEVED TO HAVE DIED IN GUYANA; BROTHER, MARVIN SWINNEY, A FORMER PT MEMBER, NOW LIVING IN SOUTH CAROLINA, AT

[REDACTED] S.C., TEL NO. [REDACTED] IS

APPARENTLY FEARFUL FOR HIS LIFE, DOES NOT WANT TO BE INTERVIEWED BY MEMBERS OF THE PRESS, AND IS FEARFUL REGARDING RETALIATION BY OTHER PT MEMBERS. (u)

TOUCHETTE HAD NO INFORMATION REGARDING ANY CACHE OF WEAPONS, MURDER OR ASSASSINATION PLANS REGARDING ANY GOVERNMENT OFFICIALS OR ANY PERSONS CONNECTED WITH THE PT. (u)

b6
b7c

PAGE THREE IP 89-181 UNCLAS

CONTACT WITH [REDACTED]

b6
b7C

INDIANA, TEL NO. [REDACTED], BROTHER OF THE ABOVE DECEASED CAROL JOYCE TOUCHETTE, CONFIRMS THAT APPARENTLY HIS FATHER CLEVE SWINNEY DIED IN GUYANA, HOWEVER, HIS MOTHER, HELEN SWINNEY, IS CURRENTLY RESIDING AT THE FABIAN GUEST HOUSE, PORT-A-SPAIN, TRINADAD, TEL NO. 320-25 OR TEL NO. 51113, ALONG WITH HIS BROTHER-IN-LAW CHARLES EUGENE TOUCHETTE, BOTH OF WHOM SURVIVED THE GUYANA TRAGEDY. [REDACTED] IS NOT, AND NEVER HAS BEEN A MEMBER OF THE PT AND HAS VERY LITTLE INFORMATION TO PROVIDE. (u)

COLUMBIA AT [REDACTED] S.C. LOCATE AND INTERVIEW [REDACTED]

[REDACTED] TEL NO. [REDACTED] (u)

SAN FRANCISCO AT SAN FRANCISCO, CA., LOCATE AND INTERVIEW MICKEY JEAN TOUCHETTE AT THE ABOVE LISTED TEL NO. (u)

INDIANAPOLIS AT INDIANAPOLIS, IN., INVESTIGATION CONTINUING. (u)

ARMED AND DANGEROUS (u)

BT

8

Assoc. Dir.	_____
Dep. AD Adm.	_____
Dep. AD Inv.	_____
Asst. Dir.:	_____
Adm. Serv.	_____
Crim. Inv.	_____ <i>JA</i>
Ident.	_____
Intell.	_____
Laboratory	_____
Legal Coun.	_____
Plan. & Insp.	_____
Rec. Mgnt.	_____
Tech. Servs.	_____
Training	_____
Public Affs. Off.	_____
Telephone Rm.	_____
Director's Sec'y	_____

SC0001 3320134Z

OO HI SF BBA

DE SC

O 280000Z NOV 78

28 Nov 78 01 37z

RECEIVED
FEDERAL BUREAU
OF INVESTIGATION
COMMUNICATIONS SECTION *MB*

JA FROM SACRAMENTO (89-191) (P)

TO DIRECTOR (89-4286) IMMEDIATE

SAN FRANCISCO (89-250) IMMEDIATE

BALTIMORE IMMEDIATE

BT

ALL INFORMATION CONTAINED
HEREIN IS UNCLASSIFIED
DATE 9/25/92 BY 1048 DKA/...

b6
b7C

UNCLAS

RYMUR. OO: SAN FRANCISCO

CALIFORNIA DMV ADVISED NOVEMBER 27, 1978, THEY HAVE BEEN RECEIVING CALLS FROM CITIZENS THROUGHOUT THE STATE REQUESTING DRIVER'S LICENSE PHOTOGRAPH AND THUMB PRINT OF A RELATIVE BE FURNISHED AUTHORITIES DOVER, DELAWARE, FOR COMPARISON WITH FINGERPRINTS OF DECEASED IN CAPTIONED CASE. DMV REPORTS THESE INDIVIDUALS STATE THEY HAVE BEEN INSTRUCTED TO DO THIS BY THE MORTICIAN IN DOVER. *(w)*

SACRAMENTO LOCAL AUTHORITIES AND FBI HAVE BEEN RECEIVING REQUESTS FROM NUMEROUS PERSONS WITH MISSING RELATIVES TO DETERMINE IF MISSING INDIVIDUALS ARE AMONG VICTIMS. *(w)*

REC-126 89-4286-452

23 NOV 28 1978

58 NOV 30 1978

PAGE TWO SC 89-191 UNCLAS

BALTIMORE IS REQUESTED TO ADVISE IF CITIZENS ARE BEING ADVISED AS INDICATED ABOVE AND, IF SO, IF THERE IS INDICATION THAT THE FINGERPRINTS ARE OF KNOWN POSSIBLE VICTIMS. (u)

BT

2

SFO 845 3320016Z

OO HQ NY

DE SF 0009

O 270014Z NOV 78

FM SAN FRANCISCO (8-250) (SQUAD 2) (P)

TO DIRECTOR (8-4286) (IMMEDIATE)

NEW YORK (8-495) (IMMEDIATE) (NY VIA FBIHQ)

BT

28 NOV 78 06 24z

FEDERAL BUREAU OF INVESTIGATION COMMUNICATIONS SECTION

Assoc. Dir.	_____
Dep. AD Adm.	_____
Dep. AD Inv.	_____
Asst. Dir.:	
Adm. Serv.	✓
Crim. Inv.	✓
Ident.	_____
Intell.	_____
Laboratory	_____
Legal Coun.	_____
Plan. & Insp.	_____
Rec. Mgnt.	_____
Tech. Servs.	_____
Training	_____
Public Affs. Off.	_____
Telephone Rm.	_____
Director's Sec'y	_____

UNCLAS EFTO

RYMUR; OO: SAN FRANCISCO.

ALL INFORMATION CONTAINED HEREIN IS UNCLASSIFIED DATE 9/25/92 BY 1048 DKA

RE NEW YORK TELCALLS TO SAN FRANCISCO. (u)

SAN FRANCISCO DESIROUS OF OBTAINING COPY OF THIRTEEN HOURS OF NBC VIDEO TAPE CONCERNING PEOPLE'S TEMPLE. (u)

NEW YORK, AT NEW YORK - THROUGH NBC COUNCIL [redacted] SHOULD MAKE ARRANGEMENTS FOR FBI TO PAY FOR REPRODUCTION OF TAPE AND TRANSMITTAL OF SAME TO FBI, SAN FRANCISCO (u).

BT

b6
b7c

REC-126

89-4286-453

23 NOV 23

TELETYPE TO: 211
28 NOV 30 1978

LA0623 3320320Z

OO HQ SF

DE LA

O 280320Z NOV 78

FM LOS ANGELES (89-436) (3) (P)

TO DIRECTOR (89-4286) (IMMEDIATE)

SAN FRANCISCO (89-250) (IMMEDIATE) (SF VIA FBIHQ)

BT

UNCLAS

RYMUR, OO: SAN FRANCISCO.

ALL INFORMATION CONTAINED
HEREIN IS UNCLASSIFIED
DATE 9/25/82 BY 1048 DCM/nda



b6
b7c

RE SAN FRANCISCO TELETYPE TO THE BUREAU, DATED NOVEMBER
24, 1978. (u)



ON NOVEMBER 27, 1978, SC [REDACTED] LOS ANGELES
FBI OFFICE, CONDUCTED A RECORD CHECK AT LOS ANGELES POLICE
DEPARTMENT (LAPD) WITH THE FOLLOWING RESULTS: (u)

NO RECORD OF AN ARREST FOR JAMES WARREN JONES IN 1974
OR 1975 FOR LEWD AND LASCIVIOUS CONDUCT (u) REC-126

89-4286-454

NO RECORD LAPD REGARDING DAVID WISE BEING BEAT UP BY
PAUL FLOWER WITH LIMITED INFORMATION AVAILABLE. (u)

23 NOV 28 1978

BT

#

LLLLLLLLLLLL

Handwritten signature

TELETYPE TO: 2-11
NOV 30 1978

Assoc. Dir.	_____
Dep. AD Adm.	_____
Dep. AD Inv.	_____
Asst. Dir.:	_____
Adm. Serv.	_____
Crim. Inv.	_____
Ident.	_____
Int'l.	_____
Laboratory	_____
Legal Coun.	_____
Plan. & Insp.	_____
Rec. Mgnt.	_____
Tech. Servs.	_____
Training	_____
Public Affs. Off.	_____
Telephone Rm.	_____
Director's Sec'y	_____

28 Nov 78 03 27

FEDERAL BUREAU OF INVESTIGATION
COMMUNICATIONS SECTION

SF0857 3320359Z

OO HQ SD

28 NOV 78 03 57z

DE SF 019

FEDERAL BUREAU OF INVESTIGATION COMMUNICATIONS SECTION

O 270347Z NOV 7

FM SAN FRANCISCO (89-250) (P) (SQ. 10)

TO DIRECTOR (89-4286) IMMEDIATE

SAN DIEGO (89-3.11) IMMEDIATE

BT

Assoc. Dir.	
Dep. AD Adm.	
Dep. AD Inv.	
Asst. Dir.:	
Adm. Serv.	<input checked="" type="checkbox"/>
Crim. Inv.	<input checked="" type="checkbox"/>
Ident.	<input checked="" type="checkbox"/>
Intell.	
Laboratory	
Legal Coun.	
Plan. & Insp.	
Rec. Mgnt.	
Tech. Servs.	
Training	
Public Affs. Off.	
Telephone Rm.	
Director's Sec'y	

ALL INFORMATION CONTAINED HEREIN IS UNCLASSIFIED DATE 9/25/92 BY 1048 DIC/ML

UNCLAS RYMUR

THROUGH INTERVIEWS, SAN FRANCISCO DETERMINED THAT

[Redacted]

LA MESA, CALIFORNIA, DOB

[Redacted]

FCC LICENSE NUMBER

[Redacted]

WAS

A HAM RADIO OPERATOR WHO ACTED AS A RELAY STATION FOR TRANSMISSIONS BETWEEN GUYANA AND THE U.S. (u)

SAN DIEGO. AT LA MESA, CALIFORNIA. LOCATE AND INTERVIEW

[Redacted]

FOR ANY INFORMATION CONCERNING MONITORED OR RECORDED

MESSAGES WITH PARTICULAR EMPHASIS ON POSSIBLE USE OF CODES AND CONSPIRACY ASPECT THIS INVESTIGATION. (u)

"ARMED AND DANGEROUS. SUICIDAL TENDENCIES" (u)

BT

REC-126

89-1286-455

23 NOV 28 1978

58 NOV 30 1978

b6 b7c

(u)

[Handwritten signature]

VZCZCWF0900

RR HQ BA CG PX PG SF SJ

DE WF #0044 3320302

ZNR UUUUU

R 270128Z NOV 78

FM FBI WASHINGTON FIELD (89-5709) COMMUNICATIONS SECTION

TO DIRECTOR FBI (89-4286) ROUTINE

FBI BALTIMORE ROUTINE

FBI PHOENIX (89-271) ROUTINE

FBI PITTSBURGH ROUTINE

FBI SAN FRANCISCO ROUTINE (SF VIA FBIHQ)

FBI SAN JUAN ROUTINE (SJ VIA FBIHQ)

BT

UNCLAS
RYMUR

28 NOV 78 03 16z

RECEIVED
COMMUNICATIONS SECTION

ALL INFORMATION CONTAINED
HEREIN IS UNCLASSIFIED
DATE 9/23/02 BY Louis B. Ben...

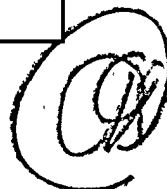

Assoc. Dir.	
Dep. AD Adm.	
Dep. AD Inv.	
Asst. Dir.:	
Adm. Serv.	
Crim. Inv.	
Ident.	
Intell.	
Laboratory	
Legal Coun.	
Plan. & Insp.	
Rec. Mgmt.	
Tech. Servs.	
Training	
Public Affs. Off.	
Telephone Rm.	
Director's Sec'y	

RE WFO TEL TO BUREAU NOVEMBER 24, 1978. (u)

ON NOVEMBER 27, 1978, [REDACTED] SECURITY, FEDERAL COMMUNICATIONS COMMISSION (FCC), WASHINGTON, D. C. (WDC), ADVISED HAM RADIO OPERATOR CALL LETTERS WERE ASSIGNED AS

FOLLOWS:

REC-126

89-4286-456

WB9CMT TO [REDACTED]

FLOSSMORE,

ILLINOIS, STATION LOCATION: [REDACTED]

23 NOV 28 1978

TELETYPE TO:

SF, SJ

58 NOV 30 1978

b6
b7c

WA3TVG TO [REDACTED] ACME, PENNSYLVANIA,

STATION LOCATION: ON [REDACTED] NEXT TO THE POST OFFICE.

KB4IJ TO [REDACTED] EST CONCORDIA [REDACTED]

ST. CROIX, AT CHRISTIANSTED, VIRGIN ISLANDS 00820, STATION
LOCATION: [REDACTED]

K3DML TO [REDACTED] POTOMAC,

MARYLAND.

ON NOVEMBER 27, 1978, [REDACTED] OFFICE MANAGER,
CONGRESSMAN RYAN, WDC, ADVISED SHE HAS NO KNOWLEDGE OF A
COMPLETE LIST OF PEOPLE WHO ACCOMPANIED THE CONGRESSMAN
FROM CALIFORNIA, AND THOUGHT THAT THE LIST WAS MAINTAINED
BY WILLIAM HOLSINGER IN CALIFORNIA. JACQUELINE SPEIER
WOULD BE THE ONLY PERSON WHO WOULD BE AWARE OF THE EXISTENCE
OF A LIST IN WDC. SPEIER IS STILL HOSPITALIZED IN BALTIMORE,
MARYLAND, AND SHE PLANS TO VISIT SPEIER ON WEDNESDAY,
NOVEMBER 29, 1978, AND WILL DETERMINE IF A LIST IS FILED IN
THE WASHINGTON OFFICE. SPEIER MAY HAVE HAD A LIST WITH
HER DURING THE TRIP. (u)

ON NOVEMBER 27, 1978, [REDACTED] ATTORNEY,

(u)

b6
b7c

PAGE THREE DE WF 0044 UNCLAS

[REDACTED] WDC, ADVISED HIS MANAGING PARTNER, [REDACTED] RECEIVED A TELEPHONE CALL ON AUGUST 16, 1978, FROM [REDACTED] A SAN FRANCISCO ATTORNEY, WHO WAS RETAINED BY THE PEOPLE'S TEMPLE (PT) TO FILE AN FOIA REQUEST. [REDACTED] WAS A FORMER LAW STUDENT WITH [REDACTED] AT GEORGE WASHINGTON UNIVERSITY. [REDACTED] IS A HAM RADIO OPERATOR AND THE EXPERT IN THE FIRM REGARDING THESE MATTERS. [REDACTED] HAS HAD COMMUNICATIONS WITH ELTON ADAM, AKA TOM, WHO IS IN CHARGE OF THE SF HAM RADIO OF THE PT. [REDACTED] KNOWLEDGE OF THIS MATTER WAS LIMITED TO THE TECHNICAL ASPECTS AND POSSIBLE VIOLATIONS OF FCC REGULATIONS. HE HAD NO INDICATION OF ANY OTHER POSSIBLE CRIMINAL VIOLATIONS. (u)

[REDACTED] WAS CONTACTED BY TELEPHONE BY PT MEMBER TERRY BUFORD CONCERNING SOME TYPE OF CIVIL LITIGATION, BUT HAS HAD NO FURTHER CONTACT WITH BUFORD. (u)

[REDACTED] BELIEVED THAT SENATOR BARRY GOLDWATER MAY HAVE BEEN BEHIND THE PT PROBLEMS WITH THE FCC (IT IS NOTED THE FCC HAS ADVISED THAT GOLDWATER IS A HAM RADIO OPERATOR AND THEY RECEIVE NUMEROUS CONGRESSIONAL INQUIRIES FROM GOLDWATER) (u)

b6
b7c

[REDACTED] HAS BEEN IN CONTACT WITH JONESTOWN THROUGH HIS HAM RADIO FOR ALMOST 1 1/2 YEARS, AND THERE WERE NO INDICATIONS OF ANY PROBLEMS. [REDACTED] WILL FURNISH WASHINGTON FIELD WITH HIS LOGS AND CONTACTS WITH ALBERT TOUCHETTE AND PAULA (LNU) IN GEORGETOWN. (u)

[REDACTED] HAS HIS OFFICE AT [REDACTED] [REDACTED] SAN FRANCISCO, TELEPHONE [REDACTED] (u)

FOR INFORMATION OF THE PHOENIX DIVISION, WASHINGTON FIELD IS NOT IN POSSESSION OF ANY FURTHER INFORMATION REGARDING [REDACTED]. IT IS NOTED THAT [REDACTED] WAS USED AS A HAM RADIO PATCH ON ONE OCCASION AND MAY NOT RECALL OR KNOW THE ORIGIN AND RELATIONSHIP WITH THE PT. (u)

b6
b7c

LEADS. BALTIMORE DIVISION. AT POTOMAC, MARYLAND. WILL INTERVIEW [REDACTED] WHO MAY HAVE MONITORED HAM RADIO OPERATIONS OF THE PT. (u)

CHICAGO DIVISION. AT FLOSSMORE, ILLINOIS. WILL INTERVIEW [REDACTED] WHO HAS REPORTEDLY MONITORED TRANSMISSIONS OF THE PT. (u)

4

PITTSBURGH DIVISION. AT ACME, PENNSYLVANIA. WILL INTERVIEW [REDACTED] WHO WAS REPORTEDLY MONITORED HAM RADIO TRANSMISSIONS OF THE PT. (u)

AT MT. PLEASANT, PENNSYLVANIA. IF NOT ALREADY DONE, WILL INTERVIEW [REDACTED] WHO HAS MONITORED PT HAM RADIO TRANSMISSIONS AND COMPLAINED TO THE FCC. (u)

b6
b7c

SAN FRANCISCO DIVISION. AT SAN FRANCISCO, CALIFORNIA. WILL INTERVIEW [REDACTED] (u)

SAN JUAN DIVISION. AT EST CONCORDIA, VIRGIN ISLANDS. WILL INTERVIEW [REDACTED] AS PER PHOENIX TELETYPE TO BUREAU NOVEMBER 25, 1978. (u)

WASHINGTON FIELD. AT WASHINGTON, D. C. WILL REVIEW ALL LETTERS SUBMITTED TO THE FCC FOR INFORMATION OF VALUE. (u)

WILL REVIEW LETTERS WRITTEN TO THE DEPARTMENT OF STATE FOR LEAD INFORMATION UPON RECEIPT OF LETTER FROM FBIHQ TO DEPARTMENT OF STATE AUTHORIZING REVIEW. (u)

BT

#0044

Assoc. Dir.	_____
Dep. AD Adm.	_____
Dep. AD Inv.	_____
Asst. Dir.:	_____
Adm. Serv.	_____
Crim. Inv.	<u>MA</u>
Ident.	_____
Intell.	_____
Laboratory	_____
Legal Coun.	_____
Plan. & Insp.	_____
Rec. Mgnt.	_____
Tech. Servs.	_____
Training	_____
Public Affs. Off.	_____
Telephone Rm.	_____
Director's Sec'y	_____

SC0003 3320120Z

00 HQ SF LA

28 Nov 78 01 27z

DE SC

RECEIVED
FEDERAL BUREAU
OF INVESTIGATION *MB*
COMMUNICATIONS SECTION

0 270005Z NOV 78

FM SACRAMENTO (89-191) (P)

TO BUREAU IMMEDIATE

SAN FRANCISCO (89-250) IMMEDIATE

LOS ANGELES IMMEDIATE

BT

UNCLAS

RYMUR. 00; SF

ALL INFORMATION CONTAINED
HEREIN IS UNCLASSIFIED
DATE 9/29/92 BY 1048 DCM/udr

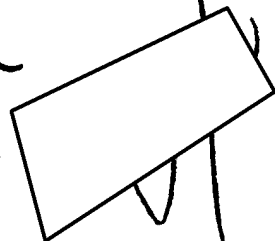

RE SC TELETYPE NOV 22, 1978, AND TELCALLS OF SA

[REDACTED] FRESNO RA TO [REDACTED] SF DIVISION
AND [REDACTED] LA DIVISION, NOV 27, 1978. (u)

b6
b7C

ON NOV 27, 1978, AT LL:40 A.M. PDT, [REDACTED]
CONTACTED FRESNO RA AND STATED THAT DAN WHITE WAS NOT KNOWN
BY HIM TO BE A MEMBER OF THE PEOPLE'S TEMPLE (PT). HE
STATED, HOWEVER, A LACK OF OBVIOUS CONNECTION BETWEEN WHITE
AND PT SHOULD NOT RULE OUT MAYOR MOSCONI'S ASSASSINATION AS
A PT RETALIATION. [REDACTED] STATED THAT THIS WAS TYPICAL
THE WAY JONES WOULD MASK HIS CRIMINAL ACTS. [REDACTED]

REC-126

89-4286 - 457

NOV 28 1978

58 NOV 30 1978

PAGE TWO. SC 89-191) UNCLAS

REITERATED JONES' POWER AND INFLUENCE IN SF POLITICS AND CLAIMED THAT BY INTIMIDATION, BRIBERY, BLACK MAIL, AND EXTORTION WHITE COULD HAVE BEEN INFLUENCED BY PT TO MURDER MOSCONI. [REDACTED] STATED HE HAD NO SOLID EVIDENCE OR REASONS BUT BELIEVED THAT IN LIGHT OF MOSCONI'S MURDER AUTHORITIES SHOULD BE ALERTED FOR AN ATTEMPT ON MAYOR TOM BRADLEY (u)

AT 11:45 A.M. PDT, [REDACTED] REPORTER, KMJ TV FRESNO, CALIFORNIA, RECEIVED A TELEPHONE CALL FROM A MALE WHO INDICATED HE WAS CALLING FROM SF AND WAS FAMILIAR WITH [REDACTED] OF KMJ'S NEWS DEPARTMENT. HE STATED HE HAD INFORMATION REGARDING MOSCONI'S ASSASSINATION IN SF. HE THEN STATED HE WAS A CURRENT MEMBER OF PT AND THAT DAN WHITE WAS A FORMER MEMBER. CALLER STATED ASSASSINATION WAS DEFINITELY A PT RETALIATION. CALLER SAID IF WHITE GETS OUT OF SF HE IS GOING TO RANCHO CORDOVA, A SMALL TOWN NEAR SACRAMENTO. HE SAID MOSCONI WAS NOT HIS ONLY TARGET AND MAYOR TOM BRADLEY OF LA WAS NEXT. HE SUGGESTED KMJ CALL BRADLEY'S OFFICE AND ALERT HIM. (u)

[REDACTED] STATED CALLER INDICATED HE WAS FLYING TO FRESNO THIS AFTERNOON AND MIGHT RECONTACT [REDACTED] CALLER DESCRIBED AS ARTICULATE MALE PROBABLY WHITE IN 20'S. CALLER VERY CONCERNED (u)

b6
b7c

2

PAGE THREE (SC 89-191) UNCLAS

ABOUT WHETHER INTERVIEW BEING TAPED. (u)

AT 12:10 P.M. PDT, SA [REDACTED] USFS FRESNO, RECEIVED CALL FROM MALE WHO STATED HE HAD TRIED TO CALL FBI FRESNO BUT RECEIVED NO ANSWER. HE STATED HE KNEW [REDACTED] WHO IS CURRENTLY ASSIGNED TO FRESNO FBI. CALLER TOLD [REDACTED] THAT MOSCONI'S ASSASSIN, DALE (SIC) WHITE WAS EN ROUTE TO RANCHO CORDOVA VIA LIVERMORE AND CASTRO VALLEY DRIVING A 1978 SILVER OVER LIGHT BLUE VAN. HE CLAIMED THIS WAS RETALIATION MURDER AND THAT WHITE WAS CONNECTED TO PT. HE HIMSELF CLAIMED TO BE A MEMBER BUT WAS LEAVING. HE STATED HE HAD SEEN THE "HIT" LIST AND MAYOR TOM BRADLEY WAS TO BE ASSASSINATED TOMORROW MORNING. [REDACTED] ASKED WHO ELSE WAS ON THE LIST AND CALLER HUNG UP. [REDACTED] DESCRIBED CALLER SIMILAR TO [REDACTED]. CALLER STATED HE WAS CALLING FROM SF AND WAS VERY CONCERNED ABOUT BEING TAPED OR TRACED. SA [REDACTED] ADVISED CALLER MIGHT BE FORMER [REDACTED] OR ONE [REDACTED], A SUSPECT IN SC 52-3026. SF IS REFERRRED TO SF LET TO SC DATED NOV 16, 1978, ON SF 183-380 (u)

IT NOW APPEARS CALLER TO KMJ AND SA [REDACTED] ARE PROBABLY SAME INDIVIDUAL. ALSO [REDACTED] REPORTER FOR CLOVIS INDEPENDENT, FRESNO, SUBURBAN NEWSPAPER, RECEIVED SIMILAR CALL AT ABOUT (u)

b6
b7C
b7D

PAGE FOUR (SC 89-191) UNCLAS

11:30 A.M. PDT. SA [REDACTED] KNOWS [REDACTED] VOICE AND ELIMINATED
HIM AS CALLER. (u)

LA AT LA. INSURE MAYOR BRADLEY ADVISED OF THREAT. (u)

SC WILL REVIEW ABOVE FILES IN EFFORT TO LOCATE [REDACTED]

AND [REDACTED] RE KNOWLEDGE OF PT. (u)

AT FRESNO WILL INTERVIEW [REDACTED] (u)

BT

b6
b7C
b7D

4

Assoc. Dir.	_____
Dep. AD Adm.	_____
Dep. AD Inv.	_____
Asst. Dir.:	_____
Adm. Serv.	_____
Crim. Inv.	_____
Ident.	_____
Intell.	_____
Laboratory	_____
Legal Coun.	_____
Plan. & Insp.	_____
Rec. Mgnt.	_____
Tech. Servs.	_____
Training	_____
Public Affs. Off.	_____
Telephone Rm.	_____
Director's Sec'y	_____

SFO 848 3320034

28 Nov 78 00 33z

OO HQ

FEDERAL BUREAU OF INVESTIGATION
COMMUNICATIONS SECTION MB

DE SF 0013

O 280035Z NOV 78

FM SAN FRANCISCO (8-250) (P) (SQ. 10)

TO DIRECTOR (8-4286) IMMEDIATE

ALL INFORMATION CONTAINED
HEREIN IS UNCLASSIFIED
DATE 9/25/92 BY 1048 DCM/ndm

BT

UNCLAS

RYMUR

BY FACSIMILE, THE SAN FRANCISCO OFFICE ON THE NIGHT OF NOVEMBER 26-27, 1978, FURNISHED THE LIST OF ALL PEOPLE'S TEMPLE (PT) MEMBERS THAT HAD GONE TO GUYANA. THIS LIST COMPILED BY ATTORNEY CHARLES GARRY, SAN FRANCISCO. (u)

ON PAGE 48, THE LAST NAME, NUMBER 960, SHOULD READ AS FOLLOWS: (u)

SMITH, KEVIN DEANE, MAY 21, 1961, B. M. (u)

BUREAU ADD TO COPIES. (u)

REC-126

89-4286-458

"ARMED AND DANGEROUS. SUICIDAL TENDENCIES". (u)

BT

28 NOV 28 1978

0-73 to
CO
11/27/78
KME

58 NOV 21 1978

SFO846 3310016Z

OO HQ HO LA NY SC SL WF

DE SF 008

28 Nov 78 00 23z

O 270007Z NOV 7

FEDERAL BUREAU OF INVESTIGATION COMMUNICATIONS SECTION

FM SAN FRANCISCO (89-250) (P) (SQ. 10)

TO DIRECTOR (89-4286) IMMEDIATE

HOUSTON IMMEDIATE

LOS ANGELES (89-436) IMMEDIATE (LA VIA FBIHQ)

NEW YORK (89-495) IMMEDIATE (NY VIA FBIHQ)

SACRAMENTO (89-191) IMMEDIATE (~~SAC VIA FBIHQ~~)

ST LOUIS IMMEDIATE

WFO (89-750) IMMEDIATE (WFO VIA FBIHQ)

BT

Assoc. Dir.	_____
Dep. AD Adm.	_____
Dep. AD Inv.	_____
Asst. Dir.:	
Adm. Serv.	_____
Crim. Inv.	_____ <i>M</i>
Ident.	_____
Intell.	_____
Laboratory	_____
Legal Coun.	_____
Plan. & Insp.	_____
Rec. Mgnt.	_____
Tech. Servs.	_____
Training	_____
Public Affs. Off.	_____
Telephone Rm.	_____
Director's Sec'y	_____

(Handwritten initials)

ALL INFORMATION CONTAINED
HEREIN IS UNCLASSIFIED
DATE 9/25/92 BY 1049 DMJ/KJA

UNCLAS
RYMUR

REC-126

89-4286-459

FOR INFORMATION PURPOSES, THE FOLLOWING PEOPLE'S
TEMPLE (PT) MEMBERS MAY BE ALLOWED TO PROCEED DIRECTLY FROM
GUYANA TO THEIR RESIDENCES IN THE U.S. WITHIN THE NEXT FEW DAYS.

IN THE EVENT THAT MEMBERS DO TRAVEL DIRECTLY TO THEIR RESIDENCES,

0-730
CO
11/27/78
KMR

NOV 28 1978
(Handwritten signature)

TELETYPE TO: all
LA 108 NOV 30 1978

PAGE TWO SF ,;-250 UNCLAS

THEY SHOULD BE LOCATED AND INTERVIEWED AT THE FOLLOWING LOCATIONS, HOWEVER, EVERY EFFORT WILL BE MADE TO OBTAIN ITINERARIES TO HAVE PERSONS INTERVIEWED UPON ARRIVAL AT RESPECTIVE AIRPORTS. (u)

THIS INFORMATION IS NOT TO BE MADE PUBLIC IN VIEW OF SURVIVING MEMBERS' FEAR OF REPRISAL (u)

SACRAMENTO: EDITH BOGUE, 17 ANCHOR DRIVE, SUISUN, CALIFORNIA; JAMES BOGUE, SAME ADDRESS; JUANITA BOGUE, SAME ADDRESS; TEENA BOGUE, SAME ADDRESS; TOM BOGUE, SAME ADDRESS; HAROLD CORDELL, SAME ADDRESS. (u)

LOS ANGELES: MARION CAMPBELL, 1435 ALVARADO TERRACE, LOS ANGELES, CALIFORNIA, 388-7535; VERSIE CONNESERO, SAME ADDRESS; HENRY CANNON, 3230 JANICE STREET, LONG BEACH, CALIFORNIA; RAY GODSHALK, 103 ROSE LANE, MONTEBELLO, CALIFORNIA; PAUL MC CANN, 4186 FOOTHILL ROAD, CARPENTERIA, CALIFORNIA. (u)

WFO: MADELINE BROOKS, 2039 NEW HAMPSHIRE AVENUE, NW, WASHINGTON, D.C.; BEA ORSOT GRUBBS, SAME AS ABOVE; LAURA JOHNSTON, SAME AS ABOVE. (u)

HOUSTON: DAWN (MITCHELL) GARDFFEY, 5600 N. FREEWAY III, HOUSTON, TEXAS; RUBY JOHNSON, SAME AS ABOVE; GUY MITCHELL, SAME AS ABOVE; LINDA MITCHELL, SAME AS ABOVE. (u)

PAGE THREE SF 89-250 UNCLAS

ST. LOUIS: AARON HENDRICKS, 5535 PERSHING AVENUE,
ST. LOUIS, MO. (u)

NEW YORK: LEE INGRAM, 29 MORE STREET, BROOKLYN,
NEW YORK, (212) 388-1419. (u)

BT

3

LA0626 3320338Z

OO HQ NO SF

DE LA

O 280338Z NOV 78

FM LOS ANGELES (89-436) (3) (P)

TO DIRECTOR (89-4286) (IMMEDIATE)

NEW ORLEANS (89-184) (IMMEDIATE)

SAN FRANCISCO (89-250) (IMMEDIATE) (SF VIA FBIHQ)

BT

UNCLAS

RY MUR, OO: SAN FRANCISCO.

RE NEW ORLEANS TELETYPE TO THE BUREAU, DATED NOVEMBER 27, 1978. (u)

[Redacted] LA PUENTE, CALIFORNIA, WAS CONTACTED BY LOS ANGELES FBI AGENTS. [Redacted] REFUSED TO DISCUSS THE CAPTIONED MATTER WITH INTERVIEWING AGENTS (u)

BT

DE-51

REC-126

89-4286 - 460

23 NOV 28 1978

Handwritten signature

RECEIVED
FEDERAL BUREAU
OF INVESTIGATION
COMMUNICATIONS SECTION
ALL INFORMATION CONTAINED
HEREIN IS UNCLASSIFIED
DATE 9/25/02 BY 1048 DCH/pda

MO

Assoc. Dir.	_____
Dep. AD Adm.	_____
Dep. AD Inv.	_____
Asst. Dir.:	_____
Adm. Serv.	_____
Crim. Inv.	_____
Ident.	_____
Intell.	_____
Laboratory	_____
Legal Coun.	_____
Plan. & Insp.	_____
Rec. Mgnt.	_____
Tech. Servs.	_____
Training	_____
Public Affs. Off.	_____
Telephone Rm.	_____
Director's Sec'y	_____

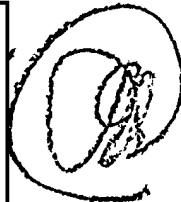

b6
b7c

15 NOV 30 1978
SF

PAGE 01 STATE 300468

ORIGIN CA-01

28 Nov 78 01 38

Assoc. Dir.	_____
Dep. AD Adm.	_____
Dep. AD Inv.	_____
Asst. Dir.:	_____
Adm. Serv.	_____
Crim. Inv.	_____
Ident.	_____
Insp.	_____
Laboratory	_____
Legal Coun.	_____
Plan. & Insp.	_____
Rec. Mgmt.	_____
Tech. Servs.	_____
Training	_____
Public Aff's Off.	_____
Telephone Rm.	_____
Director's Sec'y	_____

INFO OCT-01 ARA-11 ISO-00 SCS-00 COMMUNICATIONS SECTION SSO-00 SY-05

FBIE-00 CIAE-00 INR-10 NSAE-0P INRE-00 DGDE-00

/149 R

DRAFTED BY CA:TEGLOVER:LIM

APPROVED BY ARA:JABUSHNELL

SCS:AGISE

S/S-O:TREYNDERS

ALL INFORMATION CONTAINED
HEREIN IS UNCLASSIFIED
DATE 9/25/92 BY 1049 DCA/ada

-----AAAAAAAAAAAAQPQYUO 280132Z /64

O 280019Z NOV 78

FM SECSTATE WASHDC

FEDERAL GOVERNMENT

TO AMEMBASSY PORT OF SPAIN IMMEDIATE

Leo Ryan

LIMITED OFFICIAL USE STATE 300468

E.O. 11652: N/A

TAGS: CASC, OREP, TY - KJANARO, RICHARD)

SUBJECT: PRESENCE IN PORT OF SPAIN OF MEMBERS OF PEOPLE

TEMPLE MOVEMENT

REF: PORT OF SPAIN 03395

REC-126 89-4286 - 461

23 NOV 28 1978

b6 Per Dept. of St.

1. DEPARTMENT HAS RECEIVED REQUEST FROM []

[] COUSIN OF RICHARD JANARO. HE REQUESTS

MR. JANARO CONTACT HIM AT 5 QYAWWQAYTEP FOR ANY AID AND ASSISTANCE. MR. [] STATES HE REPRESENTS EAST

58 NOV 30 1978 EAST BRANCH OF MR. JANARO'S RELATIVES. VANCE

M00002 3320153Z

RR HQ SF

DE MO

R 272200Z NOV 78

FM MOBILE (89-67) (P)

TO DIRECTOR (89-4286) ROUTINE

SAN FRANCISCO ROUTINE

BT

UNCLAS E F T O

RYMUR

28 Nov 78 02 05z

RECEIVED
FEDERAL BUREAU
OF INVESTIGATION
COMMUNICATIONS SECTION

MB

ALL INFORMATION CONTAINED
HEREIN IS UNCLASSIFIED
DATE 2/25/92 BY 1048 DLM/ada

Assoc. Dir.	
Dep. AD Adm.	
Dep. AD Inv.	
Asst. Dir.:	
Adm. Serv.	
Crim. Inv.	
Ident.	
Intell.	
Laboratory	
Legal Coun.	
Plan. & Insp.	
Rec. Mgnt.	
Tech. Servs.	
Training	
Public Affs. Off.	
Telephone Rm.	
Director's Sec'y	

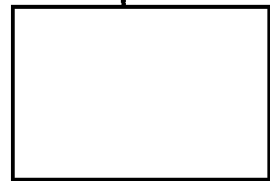

RE BUREAU TELETYPES NOVEMBER 24, 1978. (u)

ON NOVEMBER 27, 1978,



JACKSON, ALA., OWNER OF

JACKSON, ALA., STATED THAT HE HOLDS A FIRST CLASS COMMERCIAL
RADIO LICENSE. HE IS ALSO A HAM OPERATOR WITH CALL LETTERS

STATED THAT HIS FIRST CONTACT WITH

THE PEOPLES TEMPLE (PT) IN GUYANA WAS APPROXIMATELY FIVE MONTHS
AGO AT WHICH TIME HE HEARD THEM ON HIS HAM RADIO AND THEY WANTED
ANYONE INTERESTED IN A QSL CARD. HE STATED HE RECEIVED TWO POST-
CARDS FROM THEM DATED JULY 22 AND AUGUST 27, 1978. THESE POST-
CARDS WERE SIGNED BY DREW AND AL, AND WES AND AL. ACCORDING TO (u)

REC-126

89-4286 - 462

23 NOV 28 1978

58 DEC 1 1978

RDS

b6
b7C

PAGE TWO MO 89-67 UNCLAS E F T O

THE POSTCARDS, AL IS ALBERT TOUCHETTE, WHOSE CALL LETTERS ARE WB6MID/8R3, PORT KAITUMA N.W.R. GUYANA, SOUTH AMERICA. (u)

[REDACTED] STATED HE HEARD APPROXIMATELY 50 OR 60 TRANSMISSIONS OVER THE PAST FIVE MONTHS. HE STATED HE DID NOT KNOW IF ANY WERE MADE BY REVEREND JIM JONES HIMSELF OR NOT. HE STATED ONE PERSON IDENTIFIED HIMSELF AS RON, ANOTHER AS SUE OR SUSAN, ANOTHER AS DICK AND ONE AS AL. [REDACTED] STATED THAT SOMETIME IN JULY OR AUGUST, 1978, HE OVERHEARD A TRANSMISSION FROM A BOAT GOING TO MAINLAND GUYANA, WHICH WAS HAVING PROBLEMS WITH THE ENGINE AND CALLED ON THE HAM FREQUENCY TWENTY METERS, AND HE STATED THE COAST GUARD GOT INVOLVED WANTING TO KNOW WHY THEY WERE ON THAT FREQUENCY INSTEAD OF THE COMMERCIAL FREQUENCY. THE TRANSMISSION STATED NOT TO LET ANYONE ON BOARD AND TO SINK IT IF ANYONE ATTEMPTED TO BOARD. HE STATED THIS TRANSMISSION MAY HAVE BEEN FROM THE PT BUT HE HAD NO WAY OF KNOWING SINCE THEY DID NOT IDENTIFY THEMSELVES. (u)

[REDACTED] STATED HE DID NOT HAVE ANY KNOWLEDGE OR INFORMATION THAT ANY MURDER OR SUICIDE WAS CONTEMPLATED BEFORE THIS OCCURRED. HE STATED THAT HE OVERHEARD THE TRANSMISSIONS BETWEEN PT AT GUYANA AND THE PT AT SAN FRANCISCO, AND STATED THAT ON WEDNESDAY (u)

b6
b7c

2

PAGE THREE MO 89-67 UNCLAS E F T O

PRIOR TO THE KILLING OF CONGRESSMAN RYAN THE TRANSMISSIONS
APPEARED TO BE MADE WITH A LOT OF DISSENSION. (u)

[REDACTED] STATED HE DID NOT KNOW ANYONE ASSOCIATED WITH THE
PT AND COULD NOT FURNISH ANY ADDITIONAL INFORMATION IN THIS
MATTER. HE STATED THAT HE RECORDED SOME OF THE TRANSMISSIONS
BUT DOES NOT BELIEVE HE HAS ANY OF THESE RECORDINGS AT THE
PRESENT TIME SINCE THEY WERE PROBABLY ERASED. (u)

ARMED AND DANGEROUS. (u)

BT

b6
b7C

P 271531Z NOV 78

FM JCS WASHINGTON DC//J3//

TO ZEN/SECDEF WASHINGTON DC

RUEHC/SECSTATE WASHINGTON DC

RUEAIIA/CIA WASHINGTON DC

RUEJDCA/DCA WASHINGTON DC

RUEAUSA/DCPA WASHINGTON DC

ZEN/DIA WASHINGTON DC

RUEBDSA/DLA CAMERON STATION VA

RUEOAKA/DMA WASHINGTON DC

RUEBDBA/DNA WASHINGTON DC

RUEBJGA/DEPT OF TRANSPORTATION WASHINGTON DC

RUEOGBA/FAA WASHINGTON DC

RUETIAA/NSACSS FT GEORGE G MEADE MD REC-123

RUEBJGA/COMDT COGARD WASHINGTON DC

RUWRNLB/CINCAD PETERSON AFB CO

RUCBSAA/CINCLANT NORFOLK VA

RUSNAAA/USCINCEUR VAIHINGEN GE

RUEBPAA/F B I WASHINGTON DC//DIR//

RUCIMAA/CINCMAC SCOTT AFB IL

Assoc. Dir.	
Dep. AD Adm.	
Dep. AD Inv.	
Asst. Dir.:	
Adm. Serv.	
Crim. Inv.	
Ident.	
Intell.	
Laboratory	
Legal Coun.	
Plan. & Insp.	
Rec. Mgnt.	
Tech. Servs.	
Training	
Public Affs. Off.	
Telephone Rm.	
Director's Sec'y	

ALL INFORMATION CONTAINED
HEREIN IS UNCLASSIFIED
DATE 9/25/92 BY 1092 DKM/rdr
FEDERAL GOVERNMENT

0
LCA

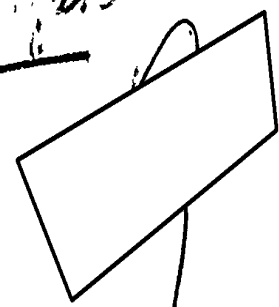

b6 per FBI
b7C

89-4286-463

23

8 NOV 30 1978

PAGE 2 RUEKJCS 2790 UNCLAS

RUHQHGA/CINCPAC HONOLULU HI

RUCJAAA/USCINCPAC MACDILL AFB FL

RUWTEKA/CINCSAC OFFUTT AFB NEB

RULPALJ/USCINCSO QUARRY HEIGHTS CZ 125

RUEADWD/CSA WASHINGTON DC

RUENAAA/CNO WASHINGTON DC

RUEAHQA/CSAF WASHINGTON DC

RUEACMC/CMC WASHINGTON DC

INFO RUEADWW/WHITE HOUSE WASHINGTON DC//SITROOM

BT

UNCLAS 4796

SUBJ: JCS CRISIS ACTION TEAM TERMINATION

REF: JCS 201330Z NOV 78

1. THE REFERENCE ACTIVATED THE JCS CRISIS ACTION TEAM TO SUPPORT SECSTATE DURING THE GUYANA HUMANITARIAN OPERATION.
2. EFFECTIVE 271700Z THE JCS CRISIS ACTION TEAM TO SUPPORT GUYANA OPERATIONS IS TERMINATED.

BT

#2790

2

FEDERAL BUREAU OF INVESTIGATION
NATL. CRIME INFO. CENTER

FEDERAL GOVERNMENT

NOV 18 1978

JAB
TELETYPE

MLO180663
AM. DCDO5000J
21:39 11/18/78 00002
21:39 11/18/78 00072 FBFBIAWAO
TXT FBFBIAWAO, DCDO50000.
MSGNO 79-68 U. S. DEPT. OF STATE, OFFICE OF SECURITY, WASHDC, 11/18/78
HQ, FBI- WASHINGTON, D. C. ATTN* DIVISION 6
COMMAND CENTER, USDO5 OFFICE OF SECURITY, WASHDC
SUBJ: ASSASSINATION OF CONGRESSMAN RYAN (CODEL)
STATE DEPT GEORGETOWN FLASH CABLE 03776

CONFIRMS THE
ALL INFORMATION CONTAINED
HEREIN IS UNCLASSIFIED
DATE 11/29/92 BY 1089 DEM/MLL
NOV 18 1978

Leo Ryan

MLO180663
SHOOTING
DEATH OF CONG. RYAN FROM CALIFORNIA, AND OTHER MEMBERS OF CODEL,
PLUS THE DEPUTY CHIEF OF MISSION (DCM) AND UNSPECIFIED OTHERS.
THE GROUP WAS FIRED UPON AS SOON AS ONE 5 SEAT CESSNA PLANE WAS
LOADED AND OTHERS WERE PREPARING TO LDARK THE LARGER OF THE TWO AIR
FT.
ONE OF THE RELIGIOUS SECT MEMBERS HAD EVIDENTLY SECKETED HIMSELF INTO
THE "DEFECTING" GROUP, ENIERE

Ⓢ

MLO180663
D THE CESSNA AND PROCEEDED TO SHOOT EVERYON
E
IN THE CRAFT. THIS WAS A SIGNAL FOR OTHER MEMBERS TO ASSAULT FROM
AN UNKNOWN POSITION. THIS GROUP APPROACHED THE AIRCRAFT AND FIRED UPON
CODEL, AND OTHERS.
AS OF THIS TIME DCM AND CONGRESSMAN (BODY) ET AL HAVE BEEN
LEFT BEHIND AS ONLY THE PILOTS AND ONE WOUNDED DEFECTING MEMEBR
MADE IT VIA THE BACK UP PLANE TO GEORGETOWN. IT

MLO180663
IS NOT KNOWN
AT THIS TIME THE CONDITION OF OTHER CODEL MEMBERS. THE DCM WAS LAST
SEEN BEING STRUCK BY GUNFIRE BUT AMBULATORY. RYAN WAS LAYING DEAD
AS TTE PILOT TOOK THE BACK UP PLANE OFF FOR GEORGETOWN.
ANY FURTHER QUESTIONS CAN BE ANSWERED BY CALLING US DIRECTLY
AT 632 2412.

REC-102

89-4286-464

END
SA [] A/ SY/ CC 11/18/78 2345HRS.

NOV 29 1978

58 NOV 30 1978

b6
b7c

QCRB
ALL INFORMATION CONTAINED
HEREIN IS UNCLASSIFIED
DATE 9/25/92 BY 1018 acd/pdh

San
DIST

~~CONFIDENTIAL~~

DEPARTMENT OF STATE
Operations Center

FEDERAL GOVERNMENT

(GUYANA WORKING GROUP)

Situation Report No. VII

Leo Ryan

- S
- D
- P
- E
- T
- M
- C
- S/S (3)
- S/S-O (2)
- S/S-S
- S/P
- PM
- INR
- PA/HO
- MILREP (2)
- EDITOR (1)
- WH (LDX)
- DOD (LDX)*
- CIA (LDX)
- NSA (LDX)
- ICA
- H
- ARA(10)
- CA (5)

Situation in Guyana as of 1130 Hours (EST), November 20, 1978

The Guyanese Crisis Committee has approved our offer of medical evacuation and grave registration units, including up to 12 helicopters. The National Military Command Center (NMCC) is mobilizing the units. The helicopters are expected to arrive early November 21.

Our DCM to Panama, who is helping at Georgetown, and a consular officer are flying to Jonestown this morning with three press representatives and Guyanese officials and will make an initial assessment of the situation there. They are expected to report their findings this afternoon. Another flight will bring our pathological and poisons experts to Jonestown this afternoon. Ambassador Burke also now advises that the 4-man DOD communications team will fly up to Jonestown today. They are expected to begin transmissions from Jonestown this afternoon.

(Handwritten initials in a circle)

- AID
- M/CT
- PA/PRS
- FBI**
- JUSTICE

The Air Force is investigating whether the Matthews Ridge airstrip can take aircraft as large as C-130s so that it can be used as a staging area for operations in Jonestown. The airstrip is about 35 miles away from Jonestown, and its use would considerably ease supply problems and facilitate evacuation activities.

- * DOD PA
- Duty Officer
- NMCC (LDX)

The Guyanese Government has requested the loan of two Otter or similar aircraft. The American Peoples Temple crisis has overtaxed Guyana's domestic air transport system, which is critical for the supply of many isolated Guyanese communities. NMCC has no Otters; but is looking into alternative ways of responding to this request.

REC-102 *89-4286-465*

Ambassador Burke advises that autopsies have been performed on the bodies of Congressman Ryan and the four others killed during the attack at Port Kaituma and that they are ready for transport back to the United States. SCS is coordinating their movement with the NMCC. Also Ambassador Burke advises that Guyana will probably require that autopsies be done only on a representative sample of the dead at Jonestown before authorizing the return of the bodies to the United States.

NOV 29 1978

John Bushnell
John Bushnell, ARA Director,
Guyana Working Group

Thomas G. Martin
Thomas G. Martin,
Senior Watch Officer

58 NOV 29 1978

~~CONFIDENTIAL~~

~~CONFIDENTIAL~~

ALL INFORMATION CONTAINED
HEREIN IS UNCLASSIFIED
DATE 9/25/82 BY 1048 DCA/MLA
Neo Ryan

DIST

FEDERAL GOVERNMENT

DEPARTMENT OF STATE
Operations Center

(GUYANA WORKING GROUP)

Situation Report No. VIII

Situation in Guyana as of 1830 Hours (EST), November 20, 1978

S
D
P
E
T
M
C
S/S (3)
S/S-O (2)
S/S-S
S/P
PM
INR
PA/HO
MILREP (2)
EDITOR (1)
WH (LDX)
DOD (LDX)*
CIA (LDX)
NSA (LDX)
ICA
H
ARA(10)
CA (5)

Reports by Guyanese police to U.S. Embassy Georgetown state 363 bodies of Peoples Temple adherents have been counted so far at Jonestown, including body of Rev. James Jones. Embassy believes some Jonestown residents fled into bush. There may also be additional dead not yet found.

DOD communications team has gone to Jonestown but communications system not yet functioning. Advice from pathologists in U.S. makes it questionable that after 50 hours bodies at Jonestown can be evacuated and local burial may be required.

U.S. military now plans fly in three large helicopters (HH-53), to be refueled in air, plus four smaller helicopters aboard 2 C-141s. USAF has not yet determined suitability of Matthew's Ridge for C-130 use. By Wednesday morning we anticipate having about 200 American military in Guyana to assist in operation.

FBI has ordered six agents to stand by to assist in investigations if requested by GOG.

Bodies of Congressman Ryan and three newsmen will be flown out to U.S. late November 20.

Peoples Temple lawyer Mark Lane and colleague Charles Garry are in Georgetown and gave press conference November 20.

U.S. military does not possess Otter or similar aircraft as requested by GOG but other solution being examined.

John A. Bushnell
John A. Bushnell, ARA Director,
Guyana Working Group

James E. Thyden
J. Thyden,
Senior Watch Officer

REC-102

89-4286-466

17 NOV 29 1978

311
58 NOV 30 1978

SF 685

0-73 (Rev. 1-24-77)

mit

MESSAGE RELAY VIA TELETYPE

Date 11/21/78

015 P

PRECEDENCE: IMMEDIATE PRIORITY ROUTINE

CLASSIFICATION: TOP SECRET SECRET CONFIDENTIAL UNCLASSIFIED

FIELD AND LEGAT MESSAGES ONLY CLEAR EFTO

FM: DIRECTOR TO:

ALL INFORMATION CONTAINED HEREIN IS UNCLASSIFIED DATE 9/25/92 BY 1048 DCM/mbr

FEDERAL GOVERNMENT

- Attorney General
 Deputy Attorney General
 Attn: Emergency Programs Center
 Assistant Attorney General, Civil Rights Div.
 Assistant Attorney General, Criminal Div.
 Attn: Internal Security Section
 Attn: General Crimes Section
 Immigration and Naturalization Service
 U. S. Marshal's Service
 U. S. Secret Service (PID)
 Director, CIA
 Secretary of State
 Department of Treasury
 Attn: U. S. Customs
 Department of Treasury
 Attn: Bureau of Alcohol Tobacco & Firearms

- Drug Enforcement Administration
 Energy Research and Development Administration
 U. S. Postal Service
 National Aeronautics & Space Adm.
 Department of Transportation
 Attn: Director of Security
 Federal Aviation Administration
 Department of the Air Force (AFOSI)
 Department of the Army
 Naval Investigative Service
 National Security Agency (DIRNSA/NSOC (Attn: SOO))
 Commandant, U. S. Coast Guard
 Director, Defense Intelligence Agency

- The President
 White House Situation Room
 Attn:
 The Vice President
 Attn:

9

0329

(SUBJECT (TEXT BEGINS NEXT PAGE): REC-102

89-4286-467

UNKNOWN SUBJECTS; CONGRESSMAN LEO J. RYAN (DECEASED) - VICTIM, CONGRESSIONAL ASSASSINATION STATUTE.

Foreign Liaison Unit
 Route through for review
 Cleared telephonically with

- Assoc. Dir.
Dep. AD Adm.
Dep. AD Inv.
Asst. Dir.:
Adm. Servs.
Crim. Inv.
Ident.
Intell.
Laboratory
Legal Coun.
Plan. & Insp.
Rec. Mgnt.
Tech. Servs.
Training
Public Affs. Off.
Telephone Rm.
Director's Sec'y

ORIGINATOR KMR JCC RM 5030 EXT 4188

4 NOV 27 1978

b6 b7c

0329 PD

m

58 DEC 1 1978

FBI/DOJ

SF0685 3262153Z

OO HQAFD

DE SF 06

O 222147Z NOV 78

FM SAN FRANCISCO (89-250) (P)

TO DIRECTOR IMMEDIATE

TO ALL OFFICES VIA FBIHQ

BT

UNCLAS

RYMOR

22 Nov 78 22 54z
RECEIVED
FEDERAL BUREAU
OF INVESTIGATION
COMMUNICATIONS SECTION

Assoc. Dir.	_____
Dep. AD Adm.	_____
Dep. AD Inv.	_____
Asst. Dir.:	_____
Adm. Serv.	_____
Crim. Inv.	_____
Ident.	_____
Intell.	_____
Laboratory	_____
Legal Co.	_____
Plan. & Insp.	_____
Rec. Mgmt.	_____
Tech. Servs.	_____
Training	_____
Public Affs. Off.	_____
Telephone Rm.	_____
Director's Sec'y	_____



b6
b7c

FBI SAN FRANCISCO ON 11/21/78, ADVISES THAT REVEREND JAMES WARREN JONES, ALSO KNOWN AS JIM JONES, FOUNDER OF THE PEOPLE'S TEMPLE CHRISTIAN CHURCH, DISCIPLES OF CHRIST (PT), FOUNDED THE CULT GROUP IN INDIANA IN THE LATE 1960'S AND MOVED WITH SOME OF HIS FOLLOWERS TO THE UKIAH, CALIFORNIA AREA IN APPROXIMATELY 1966, WHERE HE FOUNDED THE FIRST TEMPLE KNOWN AS THE REDWOOD VALLEY TEMPLE ON EAST ROAD, REDWOOD VALLEY, CALIFORNIA, NEAR UKIAH. SUBSEQUENT TEMPLES WERE ESTABLISHED AT THE INTERSECTION OF HOOVER AND ALVARADO IN LOS ANGELES. THE ONLY TEMPLE NOW OPEN IS THE ONE IN SAN FRANCISCO. (u)

MEMBERS OF THE PT WERE COERCED INTO MAKING WRITTEN STATEMENTS CONFESSING ILLEGAL AND IMMORAL ACTS SUCH AS VOWING TO (u)

TELETYPE TO:
HFO

2

PAGE TWO SF 89-250 UNCLAS

KILL GOVERNMENT OFFICIALS WHICH WERE THEN PICKED UP AT OPEN MEETINGS OF THE TEMPLE BY THE INNER CORE MEMBERS KNOWN AS THE PLANNING COMMISSION (PC) MEMBERS. THESE STATEMENTS WERE THEN DELIVERED TO THE REVEREND JONES, WHO USED THESE STATEMENTS TO INSURE THE MEMBERS INVOLVEMENT IN THE PT MOVEMENT. (u)

INFORMATION TO DATE INDICATES FOUR TYPES OF PERSONS INVOLVED IN THIS INVESTIGATION: EX-MEMBERS, CURRENT MEMBERS, MEMBERS OF THE PLANNING COMMISSION (THE "INNER CIRCLE" OF THE PEOPLE'S TEMPLE) AND "THE ANGELS" OR "STAFF" WHO WERE THE "INNER CIRCLE OF THE PLANNING COMMISSION". THE ANGELS HAVE BEEN CHARACTERIZED AS THE "HIT MEN" BY EX-MEMBERS WHO HAVE BEEN INTERVIEWED. (u) 3

EX-MEMBERS HAVE ALSO INDICATED THE EXISTENCE OF A "CONTINGENCY PLAN" WHICH WOULD GO INTO EFFECT UNDER THE FOLLOWING CIRCUMSTANCES WITH THE FOLLOWING RESULTS: (u)

IF A PUBLIC OFFICIAL ATTEMPTED TO EXPOSE THE PT, ANGELS WERE TO KIDNAP THE PUBLIC OFFICIAL'S CHILDREN, KILL THOSE CHILDREN, KILL THEIR OWN CHILDREN, AND THEN COMMIT SUICIDE.

IF THE HEAD OF THE PT, JIM JONES, WAS ARRESTED, PUBLIC OFFICIALS (NOT FURTHER IDENTIFIED) WOULD BE KIDNAPPED AND HELD (u)

PAGE THREE SF 89-250 UNCLAS

HOSTAGE UNTIL JONES WAS RELEASED. (u)

IF THE CHURCH FELL, THE FOLLOWING PERSONS ARE TO BE ASSASSINATED: SAN FRANCISCO MAYOR MOSCONE, DUE TO HIS WITHDRAWAL OF SUPPORT FOR PT, GOVERNOR OF CALIFORNIA, THE PRESIDENT OF THE UNITED STATES, AND THEN THOSE IN LINE FOR THE SUCCESSION TO THE PRESIDENCY. APPROPRIATE OFFICIALS HAVE BEEN ADVISED. (u)

BT

~~IN INTERVIEWING ANY OF THE PEOPLE ASSOCIATED WITH THE PT, THE FOLLOWING INFORMATION SHOULD BE OBTAINED: (u)~~

- ~~ANY SPECIFIC KNOWLEDGE THAT TROUBLE OF ANY TYPE WOULD OCCUR DURING CONGRESSMAN RYAN'S VISIT TO GUYANA.~~
- ~~ANY SPECIFIC KNOWLEDGE OF THE ACQUISITION, LICENSING OR SHIPMENT OF WEAPONS BY PT MEMBERS. (u)~~
- ~~ANY SPECIFIC KNOWLEDGE OF FIREARMS TRAINING RECEIVED BY PT MEMBERS, INCLUDING SPECIFIC DATES, PLACES AND BY WHOM GIVEN.~~
- ~~ANY DIRECT KNOWLEDGE OF THREATS TO HARM ANY PUBLIC OFFICIAL OR CURRENT OR FORMER PT MEMBERS AS A RESULT OF PERSONS ATTEMPTING TO EXPOSE THE PT, INFILTRATE THE PT OR INDUCING A MEMBER TO LEAVE THE PT. (u)~~
- ~~ANY CACHING OF WEAPONS OR MONIES. (u)~~

4

~~CONFIDENTIAL~~

**ALL INFORMATION CONTAINED
HEREIN IS UNCLASSIFIED
DATE 9/25/92 BY 1048 DMK/ack
FEDERAL GOVERNMENT**

DIST

S
D
P
E
T
M
C
S/S (3)
S/S-O (2)
S/S-S
S/P
PM
INR
PA/HO
MILREP (2)
EDITOR (1)
WH (LDX)
DOD (LDX)*
CIA (LDX)
NSA (LDX)
ICA
H
ARA (10)
CA (5)

DEPARTMENT OF STATE
Operations Center

(GUYANA WORKING GROUP)

Leo Ryan Situation Report No. X

Situation in Guyana as of 0715 AM (EST), November 21, 1978

We are awaiting Embassy views on our suggestion that the victims of the Jonestown tragedy be buried at Jonestown, given the long time of the bodies in open air and the fact that we won't have significant helicopter lift capacity until Wednesday. Ambassador Burke is currently consulting with the Guyanese authorities on this situation. Meanwhile the airlift of helicopters and supplies into Georgetown begins this morning with the arrival of three aircraft carrying support equipment and two unassembled helicopters. Local burial will not significantly reduce the need for U.S. equipment and personnel needed to carry out search and rescue operations in cooperation with Guyanese authorities. Three HH-53 helicopters are scheduled to arrive in Georgetown tomorrow morning as well as four additional light helicopters.

b6 per FBI
b7C

Six FBI agents, [redacted] (CA) and [redacted] (ICA) are scheduled to depart MacDill AFB at 11:55 A.M. today. The agents will join a legal attache from Caracas who arrived yesterday.

OTHER DEVELOPMENTS

The Embassy is looking into the possibility that the Otter damaged in the ambush at Port Kaituma can be repaired if parts were to be flown in by our Military Task Force.

The Press pool which visited Jonestown yesterday has begun to file detailed stories. The pool was made up of Charles Krause and Frank Johnson of the Washington Post, Mohamed Hamaludin of Reuters/CANA and a Guyanese photographer.

John Bushnell
John Bushnell, ARA
Guyana Working Group

T. Reynders
T. Reynders,
Senior Watch Officer

REC-102

~~CONFIDENTIAL~~

89-4286-468

17 NOV 29 1978

Declassified per STATE letter 2/16/2005
UC65179DMH/ST/bpg

58 NOV 30 1978

UNITED STATES GOVERNMENT

Memorandum

- Assoc. Dir. _____
- Dep. AD Adm. _____
- Dep. AD Inv. _____
- Asst. Dir.:
- Adm. Serv. _____
- Crim. Inv. _____
- Fin. & Pers. _____
- Ident. _____
- Intell. _____
- Laboratory _____
- Legal Coun. _____
- Plan. & Insp. _____
- Rec. Mgnt. _____
- Spec. Inv. _____
- Tech. Servs. _____
- Training _____
- Public Affs. Off. _____
- Telephone Rm. _____
- Director's Sec'y _____

TO : Mr. Moore *M/ADS*

ALL INFORMATION CONTAINED
HEREIN IS UNCLASSIFIED
DATE 9/25/92 BY 1048 DKA/MDM

DATE: 11/22/78

FROM : J. O. Ingram *JOI*

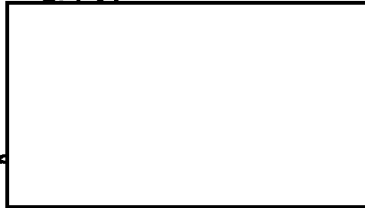

- 1 - Mr. Adams
- 1 - Mr. Moore
- 1 - Mr. Ingram
- 1 - Mr. Gow
- 1 - Mr. Wood
- 1 - Mr.
- 1 - Mr.

SUBJECT: RYMUR

best

As of 11 pm, 11/22/78, the available information from State Department indicates that bodies in route from Guyana are scheduled to arrive at Dover, Delaware, Air Force Base at 7 am on 11/23/78. Subsequent flights to arrive at six hour intervals. Conrad Banner, Identification Division, has been in contact with Bill Courtney, Chief, Air Force Mortuary Services, Dover, Delaware, telephone number 302-678-6683, and has established liaison with him with regard to contemplated use of FBI Disaster Squad.

Since information received from State Department indicated survivors would be flown to Charleston Air Force Base, Charleston, South Carolina, beginning on Saturday, 11/25/78, SAC Charles Devic, Columbia Office, was contacted and instructed to have his Charleston Resident Agency establish appropriate liaison with Air Force personnel at Charleston Air Force Base. SAC Devic subsequently advised Duty Agent that the Charleston Resident Agency had received information from OSI, Charleston, South Carolina, that a flight would arrive from Guyana on 11/23/78 containing 35 to 40 prisoners. SA contacted telephone number Guyana Desk, State Department, and informed her of information received by SAC Devic. Miss indicated she would research the matter and return the call. Miss subsequently contacted SA and advised she had determined that the Guyanese Government desires that all individuals, including bodies, be removed as soon as possible and it is very likely that a flight containing survivors will arrive sometime on 11/23/78 at Charleston, South Carolina, although this location is not definite at this point. She indicated that when a definite location is established, she will immediately contact the RYMUR command center. Information pertaining to conversation with Miss was furnished to SAC Devic, and he indicated appropriate plans would be set up to handle possible numerous interviews.

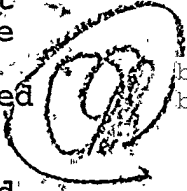

b6
b7c

REC-102 469

24 NOV 29 1978

APPROVED: _____

Director _____	Adm. Serv. _____	Legal Coun. _____
Assoc. Dir. _____	Crim. Inv. _____	Plan. & Insp. _____
Dep. AD Adm. _____	Ident. _____	Rec. Mgnt. _____
Dep. AD Inv. _____	Intell. _____	Training _____
	Laboratory _____	Public Affs. Off. _____

JCO:bvm
(8)



5010-110

Buy U.S. Savings Bonds Regularly on the Payroll Savings Plan
58 DEC 1 1978

~~CONFIDENTIAL~~

ALL INFORMATION CONTAINED
HEREIN IS UNCLASSIFIED
DATE 9/25/92 BY 1016 D/CW/1/2001

DEPARTMENT OF STATE
Operations Center
(GUYANA WORKING GROUP)

DIST

FEDERAL GOVERNMENT

Situation Report No.12

Leo Ryan

S
D
P
E
T
M
C

Dist

Situation in Guyana as of 1230 a.m. (EST), November 22, 1978

S/S (3)
S/S-O (2)
S/S-S
S/P
PM
INR
PA/HO
MILREP (2)
EDITOR (1)
WH (LDX)
DOD (LDX)*
CIA (LDX)
NSA (LDX)
ICA
H

Based on information received from the Guyanese authorities, Embassy Georgetown has transmitted the names of 174 of the deceased. The SCA Team has begun notifying the next of kin. Apparently, some elements of the press have received the same list. However, the Department will not be releasing the names to the media.

Very few survivors have been located in the Jonestown area thus far, perhaps no more than 20. Counting these, close to 70 People's Temple members are now in Georgetown. Some of these were not in Jonestown on Saturday. U.S. Military authorities believe they have sufficient facilities and personnel in Georgetown in the event of any influx of survivors.

Larry Layton, the person named as the one who started the shooting, is in Georgetown in custody of the police. To the Embassy's knowledge, he has not been charged, but is obviously being treated as a suspect. The People's Temple members in Georgetown appear to be divided into two groups, one group staying at the Georgetown police headquarters and the other elsewhere in town. Three are still in the hospital. Police officials have informed the Embassy that they prefer to keep all persons connected with the People's Temple organization available in the country for "two or three days".

USAF planes continue to arrive in Georgetown bearing equipment, supplies and support personnel. The U.S. Military Commander there reports that the Guyanese Defense Force representatives have been most cordial and helpful. Because of space limitations at the Georgetown Airport, turnaround time is being held to the minimum. The aircraft carrying the graves identification unit and equipment has been delayed because of mechanical problems and now will not be arriving in Georgetown until 0430 Georgetown time.

ARA(10)
CA (5)

AID
M/CP
PA/PRS
(tube K-5)
PA/PRS
(tube E-3)

* DOD PA
Duty Officer
NMCC (LDX)

FBI
JUSTICE

REC-102

89-4286-470

~~CONFIDENTIAL~~

Declassified per STATE letter 2/16/2005
UC65179DMH/ST/bpg

58 NOV 30 1978

NOV 29 1978

~~CONFIDENTIAL~~

-2-

We have formally requested DOD to provide transportation to the United States for People's Temple survivors who desire to leave Guyana.

AID is continuing to investigate the possibility of assisting the Guyanese Government to replace, on a temporary lease basis, the Twin Otter damaged during the attack on Congressman Ryan's party. The GOG has also requested some spare parts for aircraft in its military inventory. We have asked the Embassy to provide additional identifying information on the parts. DOD may have the items; however, the question of how they will be paid for remains to be resolved. The latest word from AID is that regulations prohibit AID from funding military transportation equipment.

Guyanese Ambassador Mann is scheduled to call on Acting Secretary Christopher on November 22 at 2:30 p.m. We expect that the purpose of the call will be for the Ambassador to express condolences and offer the continuing cooperation of his government. Mr. Christopher may have an opportunity to press for a Guyanese invitation for a visit by an FBI team. The FBI is very anxious to assist the Guyanese Government in its investigation of the People's Temple incident. An FBI team was en route yesterday, but was pulled off the plane at the last moment, at the request of Guyanese Minister Green, who informed the Ambassador that the presence of the FBI team would present a political problem for the government.

The staff director of the House International Relations Committee has informed H that Chairman Zablocki will be sending a letter to the Department containing many questions about the Department's role prior to the events in Guyana. Staffers are now working on the questions, which likely will cover all issues raised in the press and more. A decision on possible hearings will be made after receipt of the Department's response.

In response to a request from the Vice President's office, we have determined that the Vice President did not send a letter of support to People's Temple leader Jones.

~~CONFIDENTIAL~~

~~CONFIDENTIAL~~

~~-3-~~

According to Christopher Nascimento, a Guyanese official now in New York, the quotes in a People's Temple booklet attributed to Vice President Mondale were taken from statements the Vice President supposedly made, possibly during the 1976 campaign in California.

Stephen R. Gibson, ARA
Guyana Working Group

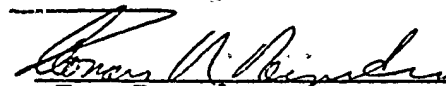
Tom Reynders,
Senior Watch Officer

~~CONFIDENTIAL~~

Memorandum

- Assoc. Dir. _____
- Dep. AD Adm. _____
- Dep. AD Inv. _____
- Asst. Dir.:
- Adm. Servs. _____
- Crim. Inv. _____
- Ident. _____
- Intell. _____
- Laboratory _____
- Legal Coun. _____
- Plan. & Insp. _____
- Rec. Mgnt. _____
- Tech. Servs. _____
- Training _____
- Public Affs. Off. _____
- Telephone Rm. _____
- Director's Sec'y _____

TO : Mr. Moore

DATE: 11/22/78

FROM : J. O. Ingram

- 1 - Mr. Adams
- 1 - Mr. Moore
- 1 - Mr. Ingram

SUBJECT: RYMUR

ALL INFORMATION CONTAINED
HEREIN IS UNCLASSIFIED
DATE 9/25/92 BY 1048 DCN/edm



(Attn: Mr. [Redacted])

b6
b7c

Jan 88

PURPOSE: To request that a cost center code for FBIHQ Command Center be established. (u)

RECOMMENDATION: If approved, the Administrative Services Division will establish a cost center code for FBIHQ RYMUR Command Center. (u)

JWM/ADW

APPROVED:

Director _____
 Assoc. Dir. _____
 Dep. AD Adm. _____
 Dep. AD Inv. _____

Adm. Serv. *rel* _____
 Crim. Inv. *JWM/ADW* _____
 Ident. _____
 Invt. _____
 Laboratory _____
 Legal Coun. _____
 Plan. & Insp. _____
 Rec. Mgnt. _____
 Tech. Servs. _____
 Training _____
 Public Affs. Off. _____



DETAILS: Captioned investigation is a Bureau-wide special concerning the murder of Congressman Leo J. Ryan on 11/18/78 in Guyana. FBIHQ Command Center has been established under direction of Deputy Assistant Director J. O. Ingram. In view of the large complement of Special Agent personnel involved in coordinating this matter and the expected addition of a support staff, a separate cost center code is advisable for cost accounting procedures. It is noted that a special major case number has already been assigned this matter for field office use. (u)

Cost center 0602 was sent up 11/27/78 (u)

PACT/jap (7)

REC-102

89-4286

471
27
NOV 27 1978



58 NOV 30 1978

~~CONFIDENTIAL~~

FEDERAL GOVERNMENT DEPARTMENT OF STATE
Operations Center
(GUYANA WORKING GROUP)

ALL INFORMATION CONTAINED
HEREIN IS UNCLASSIFIED
DATE 9/23/92 BY 1048 DKA/ubm

Just
DIST

S
D
P
E
T
M
C

Situation Report No.13

Leo Ryan

Situation in Guyana as of 0630 a.m. (EST), November 22, 1978

Military Operations

S/S (3)
S/S-O (2)
S/S-S
S/P

The majority (28 men) of the Graves Registration/Body Recovery Unit arrived in Georgetown during the night and 19 are now in Jonestown. The movement of men and material to Jonestown and Matthews Ridge is being accomplished by the three U.S. aircraft currently operational in country (one UH-1H, one OH-58 and one U-21) and Guyanese Defense Force aircraft. Reflecting yet another delay, the three HH-53 heavy helicopters are now due to arrive in Georgetown at 1300 EST. Rested crews will be in place and the aircraft can be put in immediate service.

PM
INR
PA/HO
MILREP (2)
EDITOR (1)
WH (LDX)
DOD (LDX)*
CIA (LDX)
NSA (LDX)
ICA

Four additional Huey helicopters are on the way; the first two are scheduled to arrive in Georgetown at 0920 EST. The second two will be airlifted to Guyana later today.

H
ARA (10)
CA (5)

There are currently 206 U.S. military personnel in country and there will be 300-350 by the end of the day.

AID
M/CT
PA/PRS

(tube K-5)
PA/PRS
(tube E-3)

The first ninety-six cases for body transfer (boxes suitable for stacking during shipment) will be sent from Richmond at 0900 this morning and will be in Guyana in time for the first bodies to be prepared and ready for shipment by 1630 EST. The bodies will be transferred to Dover AFB Delaware.

* DOD PA
Duty Officer
NMCC (LDX)

Of the one hundred and seventy-four bodies thus far identified by Guyanese authorities, we have no next of kin information on seventy-three. We are attempting to ascertain next of kin through passport records and inquiries. We are in the process of notifying next of kin in the other cases.

FBI
JUSTICE

REC-102

89-4286-472

~~CONFIDENTIAL~~

Declassified per State letter 2/16/2005

UC65179DMH/ST/bpg

NOV 20 1978

NOV 29 1978

~~CONFIDENTIAL~~

- 2 -

Embassy Georgetown was unofficially informed last evening that Larry Layton will be arraigned by Guyanese authorities today and charged with murder, attempted murder and related charges. Three other People's Temple members, Timothy and Michael Carter and Michael Prokes, have been taken to the "lock up" in Georgetown and may also be charged. All known survivors from Jonestown are now in Georgetown with the exception of one individual who is in Port Kaituma awaiting transportation.

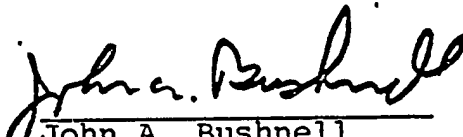
John A. Bushnell
Guyana Working Group

Tom Reynders,
Senior Watch Officer

~~CONFIDENTIAL~~

✓

FBI

TRANSMIT VIA:

- Teletype
- Facsimile
- Airtel

PRECEDENCE:

- Immediate
- Priority
- Routine

CLASSIFICATION:

- TOP SECRET
- SECRET
- CONFIDENTIAL
- E F T O
- CLEAR

WWE/086

A I R T E L

Date 11/22/78

TO: DIRECTOR, FBI

FROM: SAC, NEW HAVEN (~~203 new~~) (RUC)

SUBJECT: ~~PEOPLE'S TEMPLE~~ **RYMUR**
~~FCI GUYANA~~



ALL INFORMATION CONTAINED
HEREIN IS UNCLASSIFIED
DATE 9/25/92 BY 1046 DLM/ku

*TITLE CORRECTED PER
TELETYPE WITH SUPR.SA
11/28/78 (W)*

The New Haven Office received telephonic information from [redacted] Wallingford, Ct., [redacted] a ham radio operator. [redacted] advised that approximately two months ago he was in radio contact with ALBERT TOUCHETTE, People's Temple, Guyana, call sign WB6MID/8R3. [redacted] explained that WB6MID was an FCC radio operator's license from the California area and /8R3 was the Guyana suffix. Further information on the radio operator's license may be obtained from the FCC. (u)

b6
b7c

[redacted] advised that TOUCHETTE spoke of the country, the People's Temple, and their work. [redacted] had no further information pertaining to the group or their activities. (u)

Above for information. (u)

New Haven conducting no investigation. (u)

- 2 - Bureau
- 1 - New Haven

REC-102

DRM: amb/fat
(3)

89-4286-173

17 NOV 25 1978

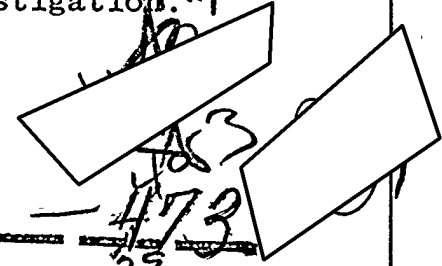

[Signature]
LIVE

Approved [Signature]

Transmitted _____ (Number) _____ (Time)

Per _____

DEPARTMENT OF JUSTICE
FEDERAL BUREAU OF INVESTIGATION
COMMUNICATION MESSAGE FORM

PAGE 1 OF 3	DATE 11/24/78	CLASSIFICATION UNCLAS	PRECEDENCE IMMEDIATE
-------------	---------------	-----------------------	----------------------

FM DIRECTOR, FBI

TO FBI SAN JUAN IMMEDIATE

FBI SAN FRANCISCO IMMEDIATE

ALL INFORMATION CONTAINED
HEREIN IS UNCLASSIFIED
DATE 9/25/92 BY 1048 DCA/ndm

BT

UNCLAS

RYMUR; 00: SAN FRANCISCO.

REBUTEL CALLS NOVEMBER 24, 1978 (u)

AS YOU ARE AWARE, FOUR MEMBERS OF THE PEOPLE'S TEMPLE (PT)
CHURCH WHO RESIDED IN JONESTOWN, GUYANA, LEFT THE JONESTOWN
CAMP PRIOR TO THE ATTACK ON THE CONGRESSMAN BY A BOAT NAMED
THE ALBATROSS AND TRAVELLED TO TRINIDAD PORT OF SPAIN. THESE
PERSONS ARE IDENTIFIED AS FOLLOWS: (u)

- CHARLES E. TOUCHETTE, DPOB SEPTEMBER 28, 1930, INDIANA;
- HELEN SWINNEY, DPOB OCTOBER 21, 1913, TEXAS;
- RICHARD MARIO JANARO, DPOB FEBRUARY 3, 1927, NEW YORK;
- PHILIP BLAKEY, BRITISH CITIZEN.

THE BOAT IS ONE OF TWO BOATS WHICH HAVE BEEN ALLEGED TO

DO NOT TYPE MESSAGE BELOW THIS LINE

89-4286-474
REC-102

APPROVED BY <i>DUNYADW</i>	DRAFTED BY LFS:KSW:ETJ	DATE 11/24/78	ROOM 406276	TELE EXT. 4656
----------------------------	------------------------	---------------	-------------	----------------

- 1 - MR. MOORE
- 1 - MR. INGRAM
- 1 - MR. GOW
- 1 - MR. []
- 1 - MR. []
- 1 - MR. []

NOV 25 1978

1 11E

58 NOV 30 1978

DO NOT FILE WITHOUT COMMUNICATIONS STAMP

FBI/DOJ

DO NOT TYPE PAST THIS LINE

b6
b7c

DEPARTMENT OF JUSTICE
FEDERAL BUREAU OF INVESTIGATION
COMMUNICATION MESSAGE FORM

PAGE 2

CONTINUATION SHEET

PAGEARTWOREDE HQ 0123 UNCLAS

20 CARRY WEAPONS FROM THE UNITED STATES TO JONESTOWN, GUYANA, FOR
18 THE PT. TOUCHETTE IS THE FATHER OF ALBERT TOUCHETTE, WHO IS
16 CONSIDERED A SUSPECT IN THE ASSASSINATION OF CONGRESSMAN RYAN.
AFTER CONSIDERABLE NEGOTIATION, THE GOVERNMENT OF TRINIDAD,
14 TOBAGO, HAS GIVEN ITS APPROVAL FOR THE VISIT OF TWO FBI AGENTS
12 TO INTERVIEW THE ABOVE PERSONS IN TRINIDAD. (u)

14 ACCORDINGLY, BUREAU AUTHORITY IS GRANTED FOR TWO AGENTS
12 OF THE SAN JUAN DIVISION TO TRAVEL TO TRINIDAD PORT OF SPAIN
10 AND INTERVIEW ABOVE PERSONS CONCERNING THEIR KNOWLEDGE OF THE
8 REVEREND JIM JONES AND ANY PLOT THE REVEREND JONES OR ANY OTHER
6 CHURCH MEMBER HAD TO ASSASSINATE CONGRESSMAN RYAN. IF TRAVEL
4 BY COMMERCIAL AIRLINES CANNOT BE ARRANGED, YOU ARE AUTHORIZED
2 TO CHARTER A PLANE FOR THE FLIGHT USING A BUREAU PILOT WHO IS
AVAILABLE AT SAN JUAN. HOWEVER, BECAUSE THE GOVERNMENT OF
TRINIDAD, TOBAGO, HAS ONLY AUTHORIZED TWO FBI AGENTS, THIS
PILOT MUST BE ONE OF THE TWO AGENTS ASSIGNED THIS LEAD. U. S.
DEPARTMENT OF STATE HAS ADVISED THAT THE ABOVE PERSONS ARE
CONSIDERING LEAVING TRINIDAD, HOWEVER, THEIR PLANS ARE AT THIS
POINT VERY TENTATIVE. THEREFORE, YOU SHOULD EXPEDITE THE
ARRANGEMENTS FOR AGENT TRAVEL AND ADVISE BY RETURN TELETYPE (u)

DO NOT TYPE MESSAGE BELOW THIS LINE

DO NOT TYPE PAST THIS LINE

2

DEPARTMENT OF JUSTICE
FEDERAL BUREAU OF INVESTIGATION
COMMUNICATION MESSAGE FORM

PAGE 3

CONTINUATION SHEET

PAGE THREE DE HQ 0123 UNCLAS

20
18
16
14
12
10
8
6
4
2

THE IDENTITIES OF THE AGENTS TRAVELING AND THEIR ESTIMATED
TIME OF ARRIVAL AND BY WHAT MEANS. (u)

UPON ARRIVAL, AGENTS SHOULD CONTACT THE U. S. EMBASSY
FOR PHYSICAL LOCATIONS OF THE ABOVE PERSONS. (u)

ARMED AND DANGEROUS. SUICIDAL TENDANCIES. (u)

BT

⌘

DO NOT TYPE PAST THIS LINE

DO NOT TYPE MESSAGE BELOW THIS LINE

3

NOTE:

BY TELETYPE 11/24/78, STATE DEPARTMENT ADVISED THAT THE GOVERNMENT OF TRINIDAD, TOBAGO, AUTHORIZED THE TRAVEL OF TWO FBI AGENTS TO TRINIDAD TO INTERVIEW FOUR PT MEMBERS. BUREAU AUTHORITY IS GRANTED FOR THIS TRAVEL.

4

UNITED STATES GOVERNMENT

UNITED STATES DEPARTMENT OF JUSTICE
FEDERAL BUREAU OF INVESTIGATION

Memorandum

Assoc. Dir. _____
 Dep. AD Adm. _____
 Dep. AD Inv. _____
 Asst. Dir.:

- Adm. Servs.
- Crim. Inv.
- Ident. _____
- Intell. _____
- Laboratory _____
- Legal Coun. _____
- Plan. & Insp. _____
- Rec. Mgnt. _____
- Tech. Servs. _____
- Training _____
- Public Affs. Off. _____
- Telephone Rm. _____
- Director's Sec'y _____

TO : Mr. Moore

DATE: 11/24/78

FROM : J. O. Ingram

ALL INFORMATION CONTAINED
 HEREIN IS UNCLASSIFIED
 DATE 4/25/82 BY 1048 OK/ldn

- 1 - Mr. Adams
- 1 - Mr. Moore
- 1 - Mr. Ingram
- 1 - Mr. Gow
- 1 - Mr. [redacted]
- 1 - Mr. [redacted]

SUBJECT: RYMUR



b6
b7C

DAILY SUMMARY (u)

The question of venue in this matter has arisen as we near the issue of anticipated prosecutions. Departmental Attorney Mike Abbell rendered the opinion that pursuant to 18 U. S. Code 3238, venue in this matter would lie primarily where the subjects are first found to be in the United States if the crime was committed extra-territorially. In this particular case, venue would lie in the Federal District of South Carolina.

Leads have been set forth to locate and interview attorneys Mark Lane, believed to be in Memphis, Tennessee, and Charles Garry, believed to be in San Francisco, California. The U. S. Attorney (USA), San Francisco, who has rendered the opinion that he also has jurisdiction in California inasmuch as that is the last known U. S. residence of the subjects, has stated that he is initiating a Federal Grand Jury inquiry into this matter in San Francisco, however, at this time, has declined to issue subpoenas to be served upon Lane and Garry when interviewed by the FBI. Similarly, issuance of subpoenas for all returning Americans at Charleston, South Carolina, was also declined. (u)

Requests are pending with the Governments of Trinidad and Guyana for the purpose of allowing FBI Agents to enter those countries to conduct interviews in this matter. To date, no reply has been received from these Governments. (u)

The Military Command Center has advised that the body count now stands at approximately 800 dead, rather than the original 409 body count. All bodies, however, will be processed through a singular location, Dover Air Force Base (DAFB), Dover, Delaware. The FBI Disaster Squad will process all bodies returned. (u)

REC-102

CONTINUED-OVER

NOV 29 1978

Buy U.S. Savings Bonds Regularly on the Payroll Savings Plan

FBI/DOJ

DES:wss
(7) wss



58 NOV 30 1978

89-4286-475
 RDS

Ingram to Moore Memorandum
RE: RYMUR

The motel that has been reserved by the Department of Health, Education, and Welfare (HEW) for reception of Americans being repatriated is the Northport Inn located approximately ¼ mile from Charleston Air Force Base (CAFB), Charleston, South Carolina. Local authorities are providing assistance to seal off the motel from unauthorized persons. Representatives of the U. S. Marshals Service will be transported to Guyana from CAFB to provide civilian law enforcement authority to the military airlift of returning Americans. A request by the FBI has been made to Immigration and Customs officials to insure the processing of all individuals by those agencies include fingerprinting and photographing of all individuals being returned to the United States.

USA, San Francisco, has authorized the filing of a complaint before the U. S. Magistrate in San Francisco charging the following individuals with the violation of the conspiracy paragraph of the Congressional Assassination Statute (18 U. S. Code 351)(d): Larry Layton, Bob Kice, Tom Kice, Joe Wilson, Albert Touchette, Eddie Crenshaw, Wesley Breidenbach, Ron James, Ron Tally, Stanley Gieb. (u)

The above complaints in support of arrest warrants are based upon the identification of these individuals as those being responsible for the shooting of Congressman Ryan and his party by [redacted] a former member of the Peoples Temple who [redacted]

At 3:45 pm, Deputy Assistant Attorney General Robert L. Keuch, Criminal Division, announced the Department would proceed with arrests. The arrest warrants will be hand carried to CAFB by two San Francisco Agents and an Assistant USA (AUSA) from the San Francisco Office who will accompany [redacted] who has already been placed in the Witness Protection Program. [redacted] will personally identify individuals named in the warrants and the warrants will be served at Charleston, South Carolina, on those individuals returning to the U. S. It is, however, recognized that some individuals may either be held in custody in Guyana or may in fact be dead. (u)

b6
b7C
b7D

The Charleston Command Post, under the personal direction of Columbia SAC Charles J. Devic has been established at the Northbrook Motel and SAC Devic has been made aware of the above information. (u)

Investigation continues. (u)

APPROVED: [signature]

Transmit attached by Facsimile - CLEAR

Precedence

25 Nov 78

0-1 112 #178

To: Director, FBI

From:

BA, BUFFALO, NEW YORK

Subject:

ATTS BURG, PITTSBURGH, PENNSYLVIA, SAN FRANCISCO

ORYMUR

From: SAC, WFO

Fingerprint Photo Fingerprint Record

Artists Conception

RECEIVED
FEDERAL BUREAU OF INVESTIGATION
COMMUNICATIONS SECTION

ALL INFORMATION CONTAINED
HEREIN IS UNCLASSIFIED
DATE 4/15/82 BY 1048 DKA/aid

Map Newspaper clipping Photograph

Other Pg 66 OF OST MAE
AUG 17 1978 ED.

Special handling instructions:

[Handwritten signature]

IMMEDIATE

Approved: *[Handwritten signature]*

Assoc. Dir.	
Dep. AD Adm.	
Dep.	
Asst. Dir.:	
Adm. Serv.	
Crim. Inv.	
Ident.	
Intell.	
Laboratory	
Legal Coun.	
Plan. & Insp.	
Rec. Mgnt.	
Tech. Servs.	
Training	
Public Affs. Off.	
Telephone Rm.	
Director's Sec'y	

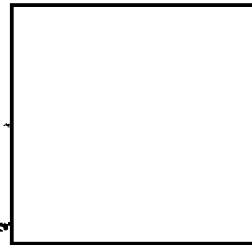

[Handwritten initials]

[Handwritten initials]

b6
b7c

REC-102

74-4286-476

NOV 29 1978

LEAD
COMP

[Handwritten initials]

58 NOV 30 1978

Revised Club Competition Rules

"Three cheers for three tiers!"

ALL INFORMATION CONTAINED
HEREIN IS UNCLASSIFIED
DATE 11/13/82 BY 10110/CLM/MLH

As early as mid-1976 the Contest Advisory Committee was studying the problem of ARRL-affiliated club competition because the giant clubs in metropolitan areas were dominating the standings. This left the smaller clubs and those in areas with few hams out of the running.

After review in early 1978 the ARRL Board of Directors approved a three-tiered competition which will allow clubs of approximately equal size to compete against each other. The revised club competition rules will be in effect for the 1978 ARRL November Sweepstakes and the 1979 January VHF Sweepstakes and International DX Competition.

Club Competition

Only ARRL-affiliated clubs may participate in the club competition. A member must be listed in the regular score listing before he can be counted for a club.

In order for a club to be listed, two points must be met:

- At least three entries from members of the club must be submitted.
- All members wishing to be included in the club scores must indicate the club name on their summary sheet and the club secretary must send a list of all club members eligible to compete for the club and which level (unlimited, medium, local) they wish to enter for each competition. Remember to meet the mailing deadline!

There are three levels of club competition:

Unlimited Any club submitting 31 or more entries would be in this class. (One station can submit two entries, one on phone and one on cw in the November Sweepstakes and the DX Competition.) All stations and all operators must reside within 175 miles of the club's center. All members more than 50 miles from the club's center must attend at least 50 percent of the club's meetings to be eligible to submit an entry. If, however, he has not been a member for a year's time, he must have attended at least 50 percent of the meetings. More so because a member. There would be no attendance requirement for those members within 50 miles. However, to be considered bona fide, a member must be active in club affairs. Members living outside of 175 miles and/or members operating without outside of 175 miles may not compete in the club competition. The club must be an ARRL-affiliated club.

Medium Any club submitting more than 10 but not more than 30 entries would be in this class. There would be the same mileage and attendance requirements as the unlimited class club. The club must be an ARRL-affiliated club.

Local Any club submitting 10 entries or less would be in this classification. All members must reside within 20 miles of the club's center. There would be no attendance requirement. Again, the club must be an ARRL-affiliate.

Single- and multioperator station scores may be counted. At a guest-estimated

single-operator station, both the guest operator and the station licensee must be members of the same club in order to count the score for that club. At multioperator stations, at least 50 percent of the operators must be members of the same club in order for the score to count for that club.

In conjunction with the 50 percent attendance rule, the club must hold at least four in-person meetings per year. A club's entry classification may be changed if, in the opinion of the ARRL Awards Committee, the club has manipulated its number of entries to fall into a lower classification (i.e., if a club with 100 members submit only the 50 highest scores, even if more than 50 of the members wish to compete).

It is not within the intent of these rules that a club should vote out a member or a member resign and then be voted back into the club later in order that he can meet the 50-percent attendance rule.

The highest-affiliated club entry will be awarded a medal in each category (unlimited, medium, local).

The highest single-operator cw score and the highest single-operator phone score in any club entry will be rewarded with a club certificate when at least three single-operator cw and/or three single-operator phone scores are submitted.

Disqualifications

The disqualification criteria within this issue or printed on page 42 of February 1978 QST.

Stays

LONG-DISTANCE DELIVERIES

From all across the United States, amateurs and doctors teamed up in February to help a missionary doctor deliver twins in a remote Guyanese village. After the mother-to-be had become two weeks overdue, then gone into prolonged labor, Dr. Larry Schacht asked Al Jankovich, W3CMT/ARRL, to call for

assistance. His first transmission, on the 20-meter Maritime Mobile Net, was answered by N2E1/4, K2P, W3DGT, W3SQV and W3HC. Changing band conditions, however, prevented completion of the exchange.

Aside the patient's complications, Al established contact later that night with more U.S. hams. They were able to phone various specialists or relay the messages to and from Dr. Schacht. Among them were K2EAL, Puzosnik, MD, who punched in Dr. Albert A. Giza-

field, an obstetrician, W3BJ, William Post, PA, an orthodontist, who punched in Dr. Kenneth L. Chang, an obstetrician, and W1VAX, Wallingford, CT, who relayed for Dr. Santa Stefano, an anesthesiologist at Yale-New Haven Hospital in Connecticut. Despite the lack of modern facilities, Dr. Schacht was talked through a Caribbean woman and delivered healthy, identical twin girls. The next day, Valentine's Day, the missionary doctor reported over the air that all were doing well.

STRAYS

LONG-DISTANCE DELIVERIES

From all across the United States, amateurs and doctors teamed up in February to help a missionary doctor deliver twins in a remote Guyanan village. After the mother-to-be had become two weeks overdue, then gone into prolonged labor, Dr. Larry Schacht asked Al Touchetts, WR6MID/8Kc, to call for assistance. His first transmission, on the 20-meter Maritime Mobile Net, was answered by N2EI/4, K4ZP, KP4DGT, WB5QAV and W7BIG. Changing band conditions, however, prevented completion of the exchange. (u)

Amidst the patient's complications, Al established contact later that night with more U. S. hams. They were able to phone patch various specialists or relay the messages to and from Dr. Schacht. Among them were K3DNL, Potomac, MD, who patched in Dr. Albert A. Greenfield, an obstetrician; W3JNJ, Williamsport, PA, an orthodontist, who patched in Dr. Kenneth L. Cooper, an obstetrician; and W4LYX, Wallingford, CT, who relayed for Dr. Sturla Stefason, an anesthesiologist at Yale-New Haven Hospital, in Connecticut. Despite the lack of modern facilities, Dr. Schacht was talked through a Caesarean section and delivered healthy, identical twin girls. The next day, Valentine's Day, the mission doctor reported over the air that all were doing well. (u)

western union Mailgram



SEATTLE WA 98155

4-001072E330 11/26/78 ICS IPMRNCZ CSP WSHB
2063622715 MGM TDRN SEATTLE WA 100 11-26 0128A EST

OUTSIDE SOURCE

ALL INFORMATION CONTAINED
HEREIN IS UNCLASSIFIED
DATE 9/25/96 BY (616) DM/whm

DIRECTOR
FBI
WASHINGTON DC 20535

Leo Ryan

WHEN I CALL LOCAL FBI OFFICE HERE I WANT TO SPEAK WITH AN AGENT, NOT LISTEN TO A GUM CHEWING ANSWERING SERVICE WITH ROCK MUSIC IN THE BACKGROUND, IT JUST MIGHT BE A BUSINESS CALL. HAVE INFO RE JIM JONES GUYANA INCIDENT, IF INTERESTED PLEASE CALL.

SEATTLE WA 98155

01:28 EST
MGMCOMP MGM

(21)
@

DE-511

REC-102

89-4286-477

NOV 29 1978

SAC PAUL MACK
ADVISED Telephonically to
COWBR LEAD
RDS 11/27/78

RDS
CORRESPONDENCE

211
50 NOV 30 1978

SEE PHONE NUMBERS

TO REPLY BY MAILGRAM, PHONE WESTERN UNION ANY TIME, DAY OR NIGHT:

FOR YOUR LOCAL NUMBER, SEE THE WHITE PAGES

OF YOUR TELEPHONE DIRECTORY

OR

DIAL (TOLL FREE) 800-257-2241

(EXCEPT IN NEW JERSEY 800-632-2271)

OR DIAL WESTERN UNION'S INFOMASTER SYSTEM DIRECTLY:

FROM TELEX 6161

FROM TWX 910 420 1212

Nov 27 2 36 PM '78

RECEIVED
CORRES-UCR
FBI

16 NOV 27 '78

COMMUNICATIONS TOLL - FI

Memorandum

Assoc. Dir. _____
 Dep. AD Adm. _____
 Dep. AD Inv. _____
 Asst. Dir.: _____
 Adm. Servs. _____
 Crim. Inv. _____
 Ident. _____
 Intell. _____
 Laboratory _____
 Legal Coun. _____
 Plan. & Insp. _____
 Rec. Mgnt. _____
 Tech. Servs. _____
 Training _____
 Public Affs. Off. _____
 Telephone Rm. _____
 Director's Sec'y _____

TO : Mr. Moore

DATE: 11/26/78

FROM : J. O. Ingram

- 1 - Mr. Adams
- 1 - Mr. Moore
- 1 - Mr. Ingram
- 1 - Mr. Gow
- 1 - Mr. [Redacted]
- 1 - Mr. [Redacted]

SUBJECT: RYMUR

ALL INFORMATION CONTAINED
 HEREIN IS UNCLASSIFIED
 DATE 9/25/92 BY 1048 DCP/whl

DAILY SUMMARY 11/25 - 11/26/78 (u)

On 11/24/78, the U.S. Attorney, San Francisco, Mr. James Hunter, after receiving authority from Deputy Attorney General Civiletti and Deputy Assistant Attorney General (DAAG) Robert Keuch, authorized complaints which were filed and warrants issued at San Francisco for the arrest of Bob Kice, Tom Kice, Joe Wilson, Albert Touchette, Ron James, Eddie Crenshaw, Ron Tally, and Wesley Bridenbach. These individuals are charged with violations of Section 351, paragraphs a and d, Title 18, U. S. Code - Conspiracy to Commit Murder and Murder of a Congressman. These are magistrate warrants and all papers regarding the warrants were sealed and no publicity afforded. As of this time, we have restricted notification of this information to SAC, Columbia, as Charleston, South Carolina is to be the port of entry of the survivors, and also Memphis for their information, in view of interviews conducted of Mark Lane at Memphis. This decision by Deputy Assistant Director (DAD) James O. Ingram is to insure this data is on a need-to-know basis at this time. (u)

b6
b7C
b7D

Key witness [Redacted] along with an Assistant U. S. Attorney and two Agents from San Francisco, are presently in Charleston, South Carolina... [Redacted] will attempt the identification of the above persons by way of a two-way mirror to be installed. Prosecutive matters are to be further discussed between the U. S. Attorney in San Francisco and the U. S. Attorney for the District of South Carolina. (u)

As of 12 Noon, 11/26/78, the Joint Chiefs of Staff (JCS) Crisis Action Team has advised that the count of known dead is 912, with 80 survivors, several of whom are known to be in Trinidad. Concerning the survivors, the State Department has advised that the exact date for their release from Guyana to return to the United States has not been determined. However,



PS:hjs (7)

REC-102

CONTINUED — OVER —

NOV 29 1978

58 NOV 30 1978

Buy U.S. Savings Bonds Regularly on the Payroll Savings Plan

Memo to Mr. Moore.
RE: RYMUR

it is believed the earliest date for release of survivors will be Tuesday, 11/28/78, pending approval of the Guyanese Government. Aircraft which will transport these people are presently at the Charleston, South Carolina Air Force Base.

SAC, Columbia has advised that he has 38 Agents available to handle interviews and the possible arrests. Agents are on the scene as of 1:00 p.m., 11/26/78. Logistical problems at Charleston as they concern the Department of Health, Education, and Welfare (HEW) have developed; however, these problems will be handled adequately by DAAG Keuch and officials of HEW, Washington, D. C. (u)

DAD Conrad S. Banner, presently on location at the Dover, Delaware Military Mortuary, has advised that there has been 22 positive identifications and a total of 478 bodies processed to date. On Noon, 11/27/78, there will be 35 pathologists on location to determine identities of victims. The pathologists do not intend to determine the cause of death and there will be no effort for autopsies. The autopsy issue was discussed with DAAG Keuch who advised he discussed this matter with Philip Heyman, AAG, and they agree Federal Government has no criminal jurisdiction of bodies at Dover; no request from Guyanese authorities for autopsies and bodies appear too mutilated at this time for autopsies. (u)

We have effected arrangements with the State Department and the Government of Trinidad for two of our Agents to fly to Trinidad to effect interviews of three known Peoples Temple members being detained in that country. In addition, through State Department and liaison with police authorities at Guyana, we have obtained a list of weapons and serial numbers that are known to have been in the Jonestown area, and these are being searched through NCIC. (u)

Peoples Temple Attorney Charles Garry, who was present during the shooting of Saturday, last, where Congressman Ryan was killed, was interviewed by the San Francisco Office on 11/24/78 and offered his cooperation. San Francisco is submitting results of the complete interview of Garry. Attorney Mark Lane, who was also present with Garry at the time of the shooting, has been interviewed. He expressed cooperation stating that he is completing a diary of the events in Guyana, after which he can more accurately talk to the FBI, and therefore he will be reinterviewed. Lane made reference to a burglary of his home, claiming the burglar was an employee of the FBI, at the time of his initial contact with the FBI. According to Lane, his information came from a CBS correspondent who identified [redacted] white male, born [redacted] as the alleged burglar. (u)

b6
b7c

Memo to Mr. Moore
RE: RYMUR

[redacted] was located at the Shelby County Jail where he has been incarcerated on bad check charges, 10/12/78. He denies contact or knowledge of Lane, the Reverend Jim Jones, or the Peoples Temple Church. He said on 11/23/78 his mother received a telephone call from a CBS newsmen who indicated that [redacted] name was found along with some of the personal belongings of Reverend Jones in Guyana. He also received subsequent contact from a correspondent at ABC. [redacted] has no idea how his name became involved with the Reverend Jones. He recalls about two weeks ago a young female called the jail identifying herself as an employee of the Department of Human Resources. She asked if he would be willing to go to an attorney's office in Memphis to take photographs. [redacted] replied that he could not do so because he was in jail. (u)

b6
b7C

Concerning the presence of additional FBI personnel in Guyana, DAAG Keuch has advised that in discussion with the State Department, it may be possible for us to send two or three Agents to go to Guyana to review 12 cabinets of records, as well as a tape recording believed to have been made at Jonestown during the last hour before the mass suicides, all of which are presently located at the American Embassy, Guyana. DAAG Keuch advised he would further pursue this with the State Department. Our liaison Agent at the JCS has further advised it is the intent of the military to secure their troops from Guyana early next week. With regard to the Charleston, South Carolina operation, it is also the intent of the military to insure that any spokesmen of the survivors be HEW so that both the FBI and the military can properly fulfill their administrative and investigative responsibilities with as little interference from the news media as possible. (u)

The U. S. Secret Service has advised by teletype that that agency has an investigation of the Peoples Temple and its members to determine the degree of danger which the group may present to protectees of the U. S. Secret Service.

The U. S. Attorney in Columbia is scheduling a press conference to discuss with the press the logistics of the arrival of the survivors and what will be expected of the press by way of cooperation in securing the interests of this Government. (u)

APPROVED: *[Signature]*
Adm. Serv. _____
Gen. Inv. *hm/gd* _____
Ident. _____
Int. _____
Lab. _____
Legal Coun. _____
Plan. & Insp. _____
Spec. Inv. _____
Training _____
Off. of Cong. & Public Affairs _____
Off. of Int. Affairs _____
Off. of Liaison & Int. Affs. _____
Off. of Records & Com. _____
Off. of Security _____
Off. of Technical Serv. _____
Off. of the Director _____

UNITED STATES GOVERNMENT

Memorandum

- Assoc. Dir. _____
- Dep. AD Adm. _____
- Dep. AD Inv. _____
- Asst. Dir.:
- Adm. Serv. _____
- Crim. Inv. _____
- Fin. & Pers. _____
- Ident. _____
- Intell. _____
- Laboratory _____
- Legal Coun. _____
- Plan. & Insp. _____
- Rec. Mgnt. _____
- Spec. Inv. _____
- Tech. Servs. _____
- Training _____
- Public Affs. Off. _____
- Telephone Rm. _____
- Director's Sec'y _____

TO : MR. D. W. MOORE, JR. *M/RDS*

DATE: 11/26/78

FROM : MR. [Redacted]

M/RDS

ALL INFORMATION CONTAINED
HEREIN IS UNCLASSIFIED
DATE 9/25/92 BY 1048 DJM/MLP

SUBJECT: RYMUR
(BUfile 89-4286)

Re San Francisco telephone call 11/26/78,
1:45 a.m. EST. *(u)*

See

SA HALE, case agent, San Francisco, telephonically
advised [Redacted] extra duty clerk, Criminal Investigative
Division, of the following: *(u)*

[Redacted] assistant to Attorney Charles Garry,
advised HALE that she had heard a televised request for
medical records in an effort to identify suicide victims
airlifted to Dover, Delaware *(u)*

[Redacted] advised HALE that she knows that cult members
were required to take medical documentation with them when
they entered the colony in Jonestown, Guyana. *(u)*

[Redacted] further advised that a dentist in Georgetown,
Guyana (name unknown) provided dental care to all of the
residents of Jonestown. *(u)*

SA HALE advised he will submit teletype with lead
requesting FBIHQ, through liaison with Department of State,
Washington, D.C., to verify existence of such records,
access to which could assist in identification of cult
victims. *(u)*

(u)
we are around
med. records
and being kept
in secure room
at AmEmb, George-
town, per Legat
R.T. Oglesby 11/27/78
Ox 11/28/78

Teletype to follow. *(u)*

[Redacted]

[Redacted]

[Redacted]

DVR/gdf

REC-102

89-4286-479

NOV 29 1978



5010-108

DEC 1 1978

Buy U.S. Savings Bonds Regularly on the Payroll Savings Plan

NNNNVV FBA112

00 RUEHFB

DE RUEHC #9149 3301914

ZNY CCCCC ZZH

0123184Z NOV 78

FM SECSTATE WASHDC

TO RUESON/AMEMBASSY GEORGETOWN IMMEDIATE 3892

RUEHZP/AMEMBASSY PANAMA IMMEDIATE 3001

RUESRS/AMEMBASSY CARACAS IMMEDIATE 3711

RUEHSP/AMEMBASSY PORT OF SPAIN IMMEDIATE 0693

RUDIC/AMEMBASSY LONDON IMMEDIATE 4214

RUEHCR/AMEMBASSY PARAMARIBO IMMEDIATE 4585

RUEHFB/FBI WASHDC IMMEDIATE

RUEBWJA/DEPT OF JUSTICE WASHDC IMMEDIATE

RULPALJ/CINCSOUTHCOM QUARRY HTS CZ IMMEDIATE

RUCIMAA/CINCMAC SCOTT AFB IMMEDIATE

RUCJAAA/USREDCOM/RCJ2 MACDILL AFB FLA IMMEDIATE

RUCLHTD/USCINCARRED FT MCPHERSON GA IMMEDIATE

RUCLGFA/CDR XVIII AIRBORNE CORPS FT BRAGG NC IMMEDIATE

BT

~~CONFIDENTIAL~~ STATE 299149

LONDON FOR MICHAEL FINLEY

REC-102

Declassified per STATE letter 2/16/2005
UC65179DMH/ST/bpg

58 NOV 30 1978
TAGS: CASC, GY

26 NOV 78 19 28z

FEDERAL BUREAU OF INVESTIGATION
COMMUNICATIONS SECTION

ALL INFORMATION CONTAINED
HEREIN IS UNCLASSIFIED
DATE 9/25/92 BY 1048DKA/wjm

Assoc. Dir.	_____
Dep. AD Adm.	_____
Dep. AD Inv.	_____
Asst. Dir.:	_____
Adm. Serv.	_____
Crim. Inv.	_____
Ident.	_____
Incl.	_____
Laboratory	_____
Legal Coun.	_____
Plan. & Insp.	_____
Rec. Mgmt.	_____
Tech. Servs.	_____
Training	_____
Public Affs. Off.	_____
Telephone Rm.	_____
Director's Sec'y	_____

Leo Ryan

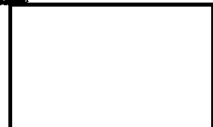

b6 Per FB
b7C

FEDERAL GOVERNMENT



RDS

*Relayed
Bas, Co, 27 US23*

89-4286-48072i sup

NOV 29 1978

SUBJECT: SITUATION REPORT NO. 21

1. THE LAST BODIES WERE REMOVED FROM THE JONESTOWN AREA SATURDAY AFTERNOON; A THOROUGH SEARCH OF THE AREA WAS CONDUCTED BEFORE DARK AND NO MORE BODIES WERE DISCOVERED. THE PLANE CARRYING THE LAST OF THE BODIES TO THE U.S. ARRIVED AT DOVER AFB AT 0310 (EST). A DOVER MILITARY SPOKESMAN ANNOUNCED LAST NIGHT THAT 912 BODIES HAD LEFT GUYANA. THE BODY OF ONE GUYANESE CITIZEN WAS HELD IN GEORGETOWN.

2. U.S. MILITARY RETROGRADE OPERATIONS HAVE BEGUN. THE EMBASSY AND U.S. TASK FORCE ARE IN THE PROCESS OF ESTABLISHING HOW MUCH MILITARY SUPPORT WILL BE REQUIRED IN THE NEXT FEW DAYS TO SUPPORT THE GOG IN SAFEGUARDING ASSETS FOUND IN THE JONESTOWN AREA AND SUPPORT INVESTIGATION ACTIVITIES. THE GUYANESE HAVE REQUESTED U.S. HELICOPTER SUPPORT FOR 30 DAYS TO ASSIST IN MAINTAINING NECESSARY SECURITY IN THE JONESTOWN AREA. THE EMBASSY HAS BEEN AUTHORIZED TO LEASE WAREHOUSE SPACE IN WHICH TO STORE THE MOVABLE PROPERTY AND EFFECTS.

3. THE TRIAL FOR LARRY LAYTON, WHO IS CHARGED WITH MURDER AS A RESULT OF THE SHOOTING AT PORT KAITUMA, HAS BEEN SET FOR JANUARY 15, 1979. NO TRIAL IS YET SET FOR CHARLES BEIKMAN.

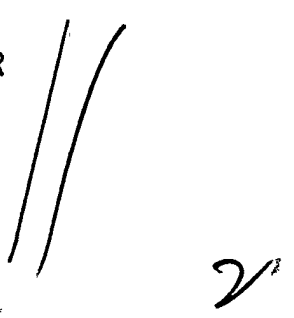

U.S. YESTERDAY THE GUYANESE RULING PARTY NEWSPAPER CARRIED
AN EDITORIAL AND CARTOON ACCUSING THE UNITED STATES OF
BEING INVOLVED IN AN INTERNATIONAL CONSPIRACY TO DISCREDIT
THE PEOPLE'S TEMPLE AND ITS SETTLEMENT IN GUYANA.

AMBASSADOR BURKE HAS PROTESTED TO THE GUYANESE GOVERNMENT
SAYING THAT THE VICIOUS TONE OF THE EDITORIAL WAS INCOM-
PREHENSIBLE IN VIEW OF THE EXCELLENT RECORD OF COOPERATION
BETWEEN THE U.S. AND THE GOG IN COMING TO GRIPS WITH A
MASSIVE TRAGEDY. THE EMBASSY SPECULATES THAT THE
EDITORIAL WAS PUBLISHED IN AN ATTEMPT TO SUPPORT DEPUTY
PRIME MINISTER REID, A PRINCIPAL SUPPORTER OF THE
PEOPLE'S TEMPLE WITHIN THE GOG. CHRISTOPHER

BT

#9149

4. THE POLICE HAVE STATED THAT ONE ELDERLY PEOPLE'S
TEMPLE MEMBER IS FREE TO LEAVE THE COUNTRY AND HE IS
DEPARTING TODAY FOR NEW YORK ON PAN AMERICAN. THE POLICE
HAVE ALSO INDICATED TO THE EMBASSY THAT OTHER MEMBERS WHO
ARE NOT DIRECTLY CONNECTED WITH THE MURDERS OF THE RYAN
PARTY OR THE AMOS FAMILY WILL BE RELEASED, BUT THEIR NAMES
WILL NOT BE KNOWN UNTIL MONDAY, NOVEMBER 27, AT THE
EARLIEST. THE REMAINING MEMBERS WILL BE ASKED TO STAY IN
GUYANA UNTIL THE PRELIMINARY HEARING SCHEDULED FOR
DECEMBER 6 OR 7.

5. ARRANGEMENTS ARE BEING MADE TO AIRLIFT MEDICAL
RECORDS RECOVERED AT JONESTOWN TO DOVER TODAY. THE
EMBASSY ALSO REPORTS THAT THE GOG WILL TODAY LEND US THEIR
IMMIGRATION CARDS BEARING THE FINGERPRINTS OF THE JONES-
TOWN DEAD, AND THESE WILL BE SENT TO DOVER AS SOON AS THEY
ARE AVAILABLE.

4

Assoc. Dir.	_____
Dep. AD Adm.	_____
Dep. AD Inv.	_____
Asst. Dir.:	_____
Adm. Serv.	_____
Crim. Inv.	_____
Ident.	_____
Intell.	_____
Laboratory	_____
Legal Coun.	_____
Plan. & Insp.	_____
Rec. Mgmt.	_____
Tech. Servs.	_____
Training	_____
Public Affs. Off.	_____
Telephone Rm.	_____
Director's Sec'y	_____

NNNVV ·FBA109.

OO RUEHFB

DE RUESON #3946 3301746

ZNY CCCCC ZZH

O R 261721Z NOV 78

FM AMEMBASSY GEORGETOWN

TO RUEHSE/USSS WASHDC//ID-FIB IMMEDIATE

INFO RUEHFB/DIRECTOR FBI

RUEHC/SECSTATE WASHDC 8216

BT

~~CONFIDENTIAL~~

26 Nov 78 18 29z

STAGE
FEDERAL BUREAU OF INVESTIGATION
COMMUNICATIONS SECTION
ALL INFORMATION CONTAINED
HEREIN IS UNCLASSIFIED
DATE 9/25/92 BY 1048 D/M/ML

FEDERAL GOVERNMENT

LIMITED OFFICIAL USE GEORGETOWN 3946

E.O. 11652: N/A

TAGS: CASC, OREP (RYAN LEO)

SUBJECT: ASSASSINATION THREAT AGAINST PRESIDENT/VICE PRESIDENT

UNITED STATES

REF: YOUR MSG, CITE NO. CO-2-78,978

DE-51

REC-102

89-4286-481

b6 per FBI
b7C

1. PARAGRAPHS KEYED TO YOUR QUERIES. WE WILL ADD USSS

TO LIST OF ADDRESSEES ON FUTURE CABLES REGARDING RETURN OF

58 NOV 30 1978
FUGITIVE MEMBERS OF THE PEOPLE'S TEMPLE.

17 NOV 29 1978

(PS)

DECL

2. WE PLAN TO NOTIFY CONCERNED AGENCIES OF THE NAMES OF PASSENGERS, ETA IN CHARLESTON, SC, ONWARD DESTINATIONS, FORWARDING ADDRESSES, ETC. WHEN AVAILABLE. AT PRESENT, IT APPEARS THAT 25 MEMBERS OF THE TEMPLE WHO ARE FREE TO ROAM FREELY, BUT NOT TO LEAVE THE COUNTRY, WILL BE RELEASED FIRST. BEST ESTIMATE AT THIS TIME IS THAT POLICE WILL FINISH WITH THEM WITHIN 48 HOURS. THE POLICE HAVE SHOWN THEMSELVES TO BE A LITTLE UNDECIDED ON THEIR USEFULNESS TO THE ONGOING INVESTIGATIONS HOWEVER, AND TIME FRAME MAY EXPAND. THE 46 CURRENTLY UNDER GUARD AT THE PT HQS AT LAMAHA GARDENS WILL APPARENTLY BE HELD FOR A LONGER PERIOD, BUT AGAIN TIME FRAME IS INDEFINITE.

3. DON SLY IS PRESUMED DEAD. HE WAS BELIEVED TO BE PRESENT AT THE MASS SUICIDE.

Muyars

4. TO DATE, ~~LARRY LAYTON~~ HAS BEEN CHARGED WITH MURDER. HE WAS BORN ON JANUARY 11, 1946 IN GREENBELT, MD. HE IS ABOUT 5' (UNCONFIRMED), THIN, FAIR COMPLEXION, LIGHT BROWN HAIR AND BLUE EYES. ~~CHARLES BEIKMAN~~ HAS BEEN CHARGED WITH THE MURDERS OF SHARON AMOS AND HER CHILDREN AT LAMAHA GARDENS. HE WAS BORN ON AUGUST 13, 1935 IN INDIANA. HIS PASSPORT NO. IS F196101, ISSUED IN SAN FRANCISCO ON FEBRUARY 12, 1974. HE IS ~~VERY~~ FAIR, HAS LIGHT HAIR, IS ABOUT 5'10 AND WEIGHTS ABOUT 200 LBS.

Ca

BURKE

BT

2

Muyars

VV FBA087

RR RUEHFB

DE RUESON #3941/1 3300600

ZNY ~~CCCC~~ ZZH

O ~~26330Z~~ NOV 78

FM EMBASSY GEORGETOWN

TO SECSTATE WASHDC 8210

INFO RUEHFB/FBI WASHDC

RUECLA/FBI 437 MASW/CP CHARLESTON SC

RUEAUSA/HE WASHDC

RUEHSE/USSS

BT

26 NOV 78 12 34z

FEDERAL BUREAU OF INVESTIGATION
COMMUNICATIONS SECTION

FBI
ALL INFORMATION CONTAINED
HEREIN IS UNCLASSIFIED
DATE 9/25/92 BY 10480 km/mcm
FEDERAL GOVERNMENT

Assoc. Dir.	
Dep. AD Adm.	
Dep. AD Inv.	
Asst. Dir.:	
Adm. Serv.	
Crim. Inv.	
Ident.	
Intell.	
Laboratory	
Legal Coun.	
Plan. & Insp.	
Rec. Mgmt.	
Tech. Servs.	
Training	
Public Affs. Off.	
Telephone Rm.	
Director's Sec'y	

Leo Ryan

b6 per FBI
b7C



~~CONFIDENTIAL~~ SECTION 1 OF 2 GEORGETOWN 3941

E.O. 11652: GDS

TAGS: GASC (PEOPLE'S TEMPLE) GY

SUBJECT: SURVIVING MEMBERS OF PEOPLE'S TEMPLE

REF: A) GEORGETOWN 3821

B) GEORGETOWN 3884

C) GEORGETOWN 3886

D) GEORGETOWN 3895

✓ E) GEORGETOWN 3898

F) GEORGETOWN 3922

G) GEORGETOWN 3932

H) USS CO-2-78, 978

CALL TOTAL 21
38 NOV 30 1978

DE-51

REC-102

89-4286-4825

referred to SF, NY & CO 11/26/78

DE-51

12 NOV 29 1978

1. THE POLICE HAVE STATED THAT MIGUEL DE PINA (84 YEARS OLD) IS FREE TO LEAVE THE COUNTRY, AND THE EMBASSY IS ASSISTING HIS GRANDSON, CURRENTLY IN GUYANA, WITH TRAVEL ARRANGEMENTS. HE PLANS TO LEAVE TOMORROW, SUNDAY, VIA PANAM TO NEW YORK BARRING OBJECTIONS FROM THE DOCTOR.

N/y H. H. H.

2. POLICE OFFICIALS HAVE INDICATED THAT THE OTHERS WHO ARE NOT DIRECTLY CONNECTED TO EITHER THE MURDER OF CONGRESSMAN RYAN AND HIS PARTY OR TO THE MURDER OF SHARON AMOS AND HER CHILDREN WILL BE RELEASED FIRST, BUT THEIR NAMES WILL NOT BE KNOWN UNTIL MONDAY NOVEMBER 27. OTHERS WILL BE ASKED TO REMAIN IN GUYANA UNTIL THE PRELIMINARY HEARING SCHEDULED FOR DEC 6 OR 7 1978.

||
||

3. FOLLOWING IS CURRENT STATUS OF THE VARIOUS GROUPS INVOLVED IN THE PEOPLE'S TEMPLE WHO ARE IN GEORGETOWN:

A. LAMAHA GARDENS, PEOPLE'S TEMPLE HQS -46- THERE HAVE BEEN TWO ADDITIONS AND TWO DELETIONS FROM THIS GROUP. THE ADDITIONS ARE [REDACTED] AND [REDACTED] WHO WERE BROUGHT INTO GEORGETOWN ABOARD THE TEMPLE'S BOAT "CUDJOE" (REF F). THE TWO DELETIONS ARE CHARLES BEIKMAN, WHO HAS BEEN ARRESTED FOR THE MRUDERS OF SHARON AMOS AND HER CHILDREN AND IS IN PRISON AWAITING TRIAL (REF A) AND MIGUEL DE PINA, WHO HAS BEEN REMOVED TO HOSPITAL (SEE ABOVE).

b6 Per Dept. of Sta

Guyana
U.S.
2

B. PARK HOTEL -29- THIS GROUP IS COMPOSED OF THE 25 FORMERLY LISTED AS THE EVE LEARY POLICE HQS GROUP, WHO ELECTED TO STAY THERE AT FIRST BUT WERE PERSUADED TO GO THE THE HOTEL, AND b6 Per Dept. of Stat
 17 ANCHOR DR. SUISAN Co WHO WAS JUST RELEASED FROM THE HOSPITAL. IT ALSO CONTAINS THE TWO CARTER BROTHERS AND MICHAEL J. PROKES, WHO WERE FORMERLY HELD IN THE POLICE LOCK-UP AT LVE LEARY BUT WHO HAVE BEEN RELEASED BY THE POLICE. THE POLICE APPEAR CONVINCED THAT THE LAST-NAMED THREE WERE NOT INVOLVED IN EITHER THE AIRPORT INCIDENT OR THE MASS SUICIDE. THE OTHERS AT THE PARK HOTEL ARE NOT SO SURE, AND THE PRESENCE OF THE CARTERS AND PROKES HAS CAUSED SOME CONSTERNATION. WE HAVE ADVISED THE POLICE THAT WE WOULD PREFER THAT THE CARTERS AND PROKES BE LODGED ELSEWHERE, IN ORDER TO AVOID ANY CONFRONTATION, BUT THEY HAVE TAKEN THEM TO THE PARK HOTEL.

*US
Suisan
Co*

C. IN PUBLIC HOSPITAL -3- BOM BOGUE, MONICA BAGBY AND MIGUEL DE PINA.

D. IN PRISON -2- LARRY LAYTON AND CHARLES BEIKMAN (REFS A AND G)

4. THE NAMES OF MOST OF THE SURVIVING MEMBERS, WITH THEIR PLANNED DESTINATIONS, ARE LISTED BELOW. THE INFORMATION ON THE REMAINDER WILL BE SUPPLIED WITH AVAILABLE. AS WE RECEIVE EXACT INFORMATION ON RELEASES WE WILL INFORM ALL ADDRESSEES. WE ASK THAT INFORMATION NOT BE MADE PUBLIC IN VIEW OF SURVIVING MEMBERS' FEAR OF REPRISAL.

5: FOR USSS: (REF H) DETAILED INFORMATION ON THE JONESTOWN BASKETBALL TEAM IS NOT READILY AVAILABLE, BUT JIM JONES, JR, STEVEAN JONES AND [REDACTED] ARE BELIEVED TO BE MEMBERS OF THE SQUAD. INFORMATION OF THE "HIT TEAM" IS SKETCHY AND UNCONFIRMED.

b6 Per Dept. of State

ADAMS, PAULA

HER LEAVING WILL PROBABLY BE DELAYED

BAGBY, MONICA

UNKNOWN

[REDACTED]
BEIKMAN, TOM

EXPECTS TO BE IN GUYANA AWAITING FATHER'S TRIAL

[REDACTED]
BOGUE, TOM

SAME AS ABOVE

[REDACTED]
BROOKS, MADELINE

2039 NE HAMPSHIRE AVE NW WASHINGTON DC

[REDACTED]
CLARK, RICHARD

446 LYON ST SAN FRANCISCO

[REDACTED]
BT

#3941

4

NNNNVV FBA089

RR RUEHFB

DE RUESON #3941/2 3300600

ZNY CCCCC ZZH

O 260330Z NOV 78

FM AMEMBASSY GEORGETOWN

TO SECSTATE WASHDC 8211

INFO RUEHFB/FBI WASHDC

RUCLSLA/FBI 437 MASW/CP CHARLESTON SC

RUEAUSA/HE WASHDC

RUEHSE/USSS

b6 Per Dept. of State

BT

~~CONFIDENTIAL~~ SECTION 2 OF 2 GEORGETOWN 3941

DAVIS, GROVER

L.C. MITCHELL, SAN MATEO CALIF

DE PINA, MIGUEL

PRESENTLY IN HOSPITAL BUT HAS

RELATIVES IN CALIF

[REDACTED]
GODSHALK, RAY

103 ROSE LANE, MONTEBELLO CA 95470

GRUBBS, BEA ORSOT

2039 NEW HAMPSHIRE AVE NW, WASHINGTON

DC

[REDACTED]
JOHNSON, RUBY

5600 NY FREEWAY #111, HOUSTON TEX

JOHNSTON, LAURA

2039 NEW HAMPSHIRE AVE NY WASHINGTON

DC

JONES, JIMMY

[REDACTED] b6 Per Dept. of State

JONES, STEPHAN

[REDACTED]
KIRKENDALL, CHUCK

3776 RUBY ST OAKLAND CA 428-1904

LOUIS, DIAME

446 LYON ST SAN FRANCISCO

[REDACTED]
MCCANN, PAUL

4186 FOOTHILL RD CARPENTERIA CA

PARKS, EDITH

SAME AS ABOVE

PAUL, ROBERT

1102 5 15 ST LOUISIA CAL 70560

b6 Per Dept. of State

PURSELEY, JOAN

2322 ACTON ST BERKELEY CA

[REDACTED]

RODRIGUEZ, AURORA

1112 LOCH AVON DR WHITTIER CA

90606 695-5276

SATTERWHITE, ALVARAY

1635 CASITIC AVE PASADENA 681-8378

SCHEID, DIANNE CASANOVA

PREFERS GUYANA, IF REQUIRED 3230

JANICE ST LONG BEACH CA

[REDACTED]

SMITH, EUGENE

SAN FRANCISCO BAY AREA

STROUD, BOBBY

HOMEDALE IDAHO-CORRECT ADDRESS NOT KNOWN

TRASH, HYACINTH

44 HOWARD ST INDIANAPOLIS, INDIANAN

[REDACTED]

TOUCHETTE, MICHAEL

HE WILL BE STAYING ON IN GUYANA

UNTIL

[REDACTED]

LEAVES

[REDACTED]

7



WILSON, LESLIE

SAME AS ABOVE



C

YOUNG, CAROL

729 W 55TH ST LOS ANGELES CA



BT

#3941

b6 Per Dept. of State

8

DIST

S
D
P
E
T
M
C

[Handwritten signature]

~~CONFIDENTIAL~~

ALL INFORMATION CONTAINED
HEREIN IS UNCLASSIFIED
DATE 9/25/92 BY 10482001/ndey

Department of State
Operations Center

FEDERAL GOVERNMENT

(GUYANA TASK FORCE)

Situation Report No. 21

D
Leo Ryan

S/S (3)
S/S-O (2)
S/P

PM
INR

Situation in Guyana as of 0900 hours (EST), November 26, 1978

PA/HO

MILREP (2)

EDITOR (1)

WH (LDX)

CIA (LDX)

NSA (LDX)

ICA

H

ARA (10)

CA

SCA (5)

AID

M/CT

PA/PRS

FBI

JUSTICE

*DOD PA

DUTY OFFICER

NMOC (LDX)

The last bodies were removed from the Jonestown area Saturday afternoon; a thorough search of the area was conducted before dark and no more bodies were discovered. The plane carrying the last of the bodies to the U.S. arrived at Dover AFB at 0310 (EST). A Dover military spokesman announced last night that 912 bodies had left Guyana. The body of one Guyanese citizen was held in Georgetown.

U.S. military retrograde operations have begun. The Embassy and U.S. Task Force are in the process of establishing how much military support will be required in the next few days to support the GOG in safeguarding assets found in the Jonestown area and support investigation activities. The Guyanese have requested U.S. helicopter support for 30 days to assist in maintaining necessary security in the Jonestown area. The Embassy has been authorized to lease warehouse space in which to store the movable property and effects.

The trial for Larry Layton, who is charged with murder as a result of the shooting at Port Kaituma, has been set for January 15, 1979. No trial is yet set for Charles Beikman.

The police have stated that one elderly People's Temple member is free to leave the country and he is departing today for New York on Pan American. The police have also indicated to the Embassy that other members who are not directly connected with the murders of the Ryan party or the Amos family will be released, but their names will not be known until Monday, November 27, at the earliest. The remaining members will be asked to stay in Guyana until the preliminary hearing scheduled for December 6 or 7.

REC-102

89-4286-483

~~CONFIDENTIAL~~

GDS

Declassified per STATE letter 2/16/2005

UC65179DMH/ST/bpg

17 NOV 29 1978

211
58 NOV 30 1978

~~CONFIDENTIAL~~

-2-

Arrangements are being made to airlift medical records recovered at Jonestown to Dover today. The Embassy also reports that the GOG will today lend us their immigration cards bearing the fingerprints of the Jonestown dead, and these will be sent to Dover as soon as they are available.

Yesterday the Guyanese ruling party newspaper carried an editorial and cartoon accusing the United States of being involved in an international conspiracy to discredit the People's Temple and its settlement in Guyana. Ambassador Burke has protested to the Guyanese Government saying that the vicious tone of the editorial was incomprehensible in view of the excellent record of cooperation between the U.S. and the GOG in coming to grips with a massive tragedy. The Embassy speculates that the editorial was published in an attempt to support Deputy Prime Minister Reid, a principal supporter of the People's Temple within the GOG.

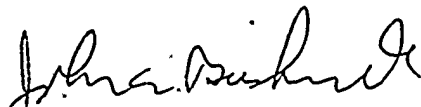
John A. Bushnell
ARA Director
Guyana Working Group

T. Reynders
Senior Watch Officer

~~CONFIDENTIAL~~

UNITED STATES GOVERNMENT

UNITED STATES DEPARTMENT OF JUSTICE
FEDERAL BUREAU OF INVESTIGATION

Memorandum

1 - Mr. Herndon

1 - Mr. [redacted]

1 - Mr. [redacted]

DATE: 11/27/78

- Assoc. Dir. _____
- Dep. AD Adm. _____
- Dep. AD Inv. _____
- Asst. Dir.: _____
- Adm. Servs.
- Crim. Inv.
- Ident.
- Intell. _____
- Laboratory _____
- Legal Coun. _____
- Plan. & Insp. _____
- Rec. Mgnt. _____
- Tech. Servs. _____
- Training _____
- Public Affs. Off. _____
- Telephone Rm. _____
- Director's Sec'y _____

TO : Mr. Herndon

FROM :

[redacted]

SUBJECT: RYMUR

ALL INFORMATION CONTAINED
HEREIN IS UNCLASSIFIED
DATE 9/23/92 BY 1048 DKM/MP

[redacted]

PURPOSE: (u)

To set forth results of Laboratory and Fingerprint examinations of handwritten note obtained from the body of deceased Reverend Jim Jones. (u)

DETAILS: (u)

On 11/24/78, the Document Section, Laboratory Division, was furnished a handwritten note taken from the body of Reverend Jim Jones. The note was delivered in a sealed container and was opened by Laboratory personnel. The note, written on a piece of lined notebook paper approximately 6 inches by eight inches contained the following message: (u)

Dad

Dad:

I see no way out - I agree with your decision - I fear only that without you the world may not make it to communism - Tish

3- ENCLOSURE
ENC. BEHIND FILE

- 1 - Mr. Adams
- 1 - Mr. Boynton
- 1 - Mr. [redacted]
- 1 - Mr. Moore
- 1 - Mr. Ingram

REC-102

89-4286-484
(u)

NOV 29 1978

CONTINUED - OVER



Encs. (3)
FMD/kaf (10) kaf

58 NOV 30 1978

Buy U.S. Savings Bonds Regularly on the Payroll Savings Plan

FBI/DOJ

b6
b7c

Memorandum to Mr. Herndon
RE: RYMUR

For my part - I
am more than
tired of this
wretched, merciless
planet & the hell
it holds for so
many masses of
beautiful people -
Thank you for the only life Ive known

Since the note was heavily saturated with body fluids and moisture it was placed in an exhaust hood and aerated in order to dry out the document as much as possible. (u)

Writing of James W. Jones, consisting of a signature on a fingerprint card FBI# 70597N2, and a signature on an FOIA request received from Jones in 1977 (190-12318) were found to be too limited in nature and inadequate to identify him as the author of this note. The same is also true of Marceline Mae Jones whose known signatures and limited writings appear on two FOIA requests received in December, 1977 (190-12318). (u)

Since the letter is signed "Tish" efforts are being made to obtain writings attributable to Jones' followers who could logically be thought to have written the note. No writings of such individuals have been received as yet. (u)

Latent Fingerprint examinations were conducted on 11/27/78 but no latent fingerprints of value were developed. (u)

The note, one black & white and one color photograph are attached. (u)

RECOMMENDATION (u)

This memorandum and attachments be forwarded to the Investigative Division for information and appropriate action. (u)

APPROVED:	Adm. Serv. _____	Legal Coun. _____
Director _____	Crim. Inv. <input checked="" type="checkbox"/>	Plan. & Insp. _____
Assoc. Dir. _____	Ident. _____	Rec. Mgnt. _____
Dep. AD Adm. _____	Intel. _____	Tech. Servs. _____
Dep. AD Inv. _____	Laboratory _____	Training _____
		Off. Affs. _____

061

RD
A H
P MB

DEPARTMENT OF JUSTICE
FEDERAL BUREAU OF INVESTIGATION
COMMUNICATION MESSAGE FORM

PAGE 1 OF 2

DATE 11/27/78	CLASSIFICATION UNCLAS E F T O	PRECEDENCE IMMEDIATE
------------------	----------------------------------	-------------------------

FM DIRECTOR FBI

START HERE

ALL INFORMATION CONTAINED
HEREIN IS UNCLASSIFIED
DATE 9/25/92 BY 1018 DKA/ada

FEDERAL GOVERNMENT

TO 416/ U. S. SECRET SERVICE
ALL FBI FIELD DIVISIONS IMMEDIATE
ALL LEGAL ATTACHES ROUTINE

BT

UNCLAS E F T O

UNKNOWN SUBJECT; CONGRESSMAN LEO J. RYAN {DECEASED} - VICTIM;

CONGRESSIONAL ASSASSINATION STATUTE.

FOR INFORMATION OF RECEIVING OFFICES, THE U. S. SECRET

SERVICE {USSS} HAS ADVISED FBIHQ THAT IT IS CURRENTLY CONDUCTING

AN EXTENSIVE INVESTIGATION INTO THE GROUP KNOWN AS THE PEOPLES

TEMPLE AND ITS MEMBERS TO DETERMINE THE DEGREE OF DANGER

WHICH THE GROUP MAY PRESENT TO PROTECTEES OF THE USSS. FBIHQ IS

MAINTAINING CLOSE LIAISON WITH USSS HEADQUARTERS AND A DETAIL OF

SECRET SERVICE AGENTS IS IN PLACE WITH THE FBI COMAND POST AT

CHARLESTON, SOUTH CAROLINA, AWAITING THE RETURN OF SURVIVORS

FROM GUYANA.

DO NOT TYPE MESSAGE BELOW THIS LINE

APPROVED BY <i>[Signature]</i>	DRAFTED BY DES/RAK {5}	DATE 11/27/78	ROOM 5015/6	TELE EXT. 4190
-----------------------------------	---------------------------	------------------	----------------	-------------------

DO NOT TYPE PAST THIS LINE

REC-102

89-4286-485

- 1 - MR. MOORE
- 1 - MR. INGRAM
- 1 - MR. GOW
- 1 - MR.

FEDERAL BUREAU OF INVESTIGATION
COMMUNICATIONS SECTION

16 NOV 29 1978

b6
b7c

NOV 28 1978

6252 TR

58 NOV 30 1978

DO NOT FILE WITHOUT COMMUNICATIONS STAMP

FBI/DOJ

DEPARTMENT OF JUSTICE
FEDERAL BUREAU OF INVESTIGATION
COMMUNICATION MESSAGE FORM

PAGE 2

CONTINUATION SHEET

~~PAGE TWO~~ *PAGE TWO 423 0061 UNCLAS E F T O

IN THIS REGARD, COLUMBIA DIVISION AT CHARLESTON, SOUTH
20 CAROLINA, IS TO INSURE THAT THE USSS BE NOTIFIED WHEN STEPHEN
18 JONES WILL BE AVAILABLE FOR INTERVIEW BY USSS. ADDITIONALLY,
THE CHARLESTON COMAND POST IS TO COORDINATE LOCALLY WITH THE
16 SIAC, USSS AT CHARLESTON TO PROVIDE USSS WITH THE MANIFEST OF
PEOPLES TEMPLE MEMBERS WHO WILL BE TRANSPORTED FROM GUYANA TO
14 CHARLESTON, SOUTH CAROLINA. INVESTIGATIVE RESPONSIBILITIES OF
USSS ARE TO BE ACCOMODATED. (u)

12 COLUMBIA SHOULD ALSO ATTEMPT TO DETERMINE THE WHEREABOUTS OF
PEOPLES TEMPLE MEMBER DON SLY (A REPORTED "HIT MAN") AND
10 FURNISH THIS INFORMATION TO USSS. (u)

ALL RECEIVING OFFICES SHOULD BE ALERT FOR ANY INFORMATION
8 IDENTIFYING MEMBERS OF THE PEOPLES TEMPLE BASKETBALL TEAM
IN GUYANA, THE "HIT TEAM", OR "ANGELS" OF THE PEOPLES TEMPLE
6 AND FURNISH SUCH INFORMATION LOCALLY TO USSS AND TO FBIHQ FOR
RELAY TO USSS HEADQUARTERS. (u)

4 RECEIVING OFFICES SHOULD COOPERATE AT THE LOCAL LEVEL WITH
USSS REGARDING INVESTIGATION OF THE PEOPLES TEMPLE (u)

2 BT

DO NOT TYPE PAST THIS LINE

DO NOT TYPE MESSAGE BELOW THIS LINE

2

062

A IX
P MH

DEPARTMENT OF JUSTICE
FEDERAL BUREAU OF INVESTIGATION
COMMUNICATION MESSAGE FORM

PAGE 1 OF

DATE

11/27/78

CLASSIFICATION

UNCLAS E F T O

PRECEDENCE

IMMEDIATE

800 SFIDE HQ 40062 3315444E0 222233Z NOV 78

START HERE

FM DIRECTOR FBI

TO TO FBI SAN FRANCISCO IMMEDIATE

BT

14 UNCLAS E F T O

RYMUR

ALL INFORMATION CONTAINED
HEREIN IS UNCLASSIFIED
DATE 9/25/92 BY WBS/DKM/jub

12 INFORMATION RECEIVED REGARDING RYMUR VICTIMS. DENTAL
RECORDS FOR MAURI AND DAREN JANARO MAY BE OBTAINED FROM DOCTOR
10 PATRICK HENRY, UKIAH, CALIFORNIA. SAN FRANCISCO OBTAIN DENTAL
RECORDS AND FORWARD TO FBI DISASTER SQUAD, DOVER AIR FORCE BASE,
8 DELAWARE, TO ASSIST IN IDENTIFICATION. (u)

BT

6

4

2

REC-12689-4286-486

16 NOV 29 1978

DO NOT TYPE MESSAGE BELOW THIS LINE

APPROVED BY

DRAFTED BY

DATE

ROOM

TELE EXT.

PTB/RAK f3f

11/27/78

5015/6

4192

PTB

- 1 - MR. []
- 1 - MR. []

FEDERAL BUREAU OF INVESTIGATION
COMMUNICATIONS SECTION

23212
NOV 27 1978

TELETYPE

58 NOV 30 1978

DO NOT FILE WITHOUT COMMUNICATIONS STAMP

FBI/DOJ

DO NOT TYPE PAST THIS LINE

b6
b7c

DEPARTMENT OF JUSTICE
FEDERAL BUREAU OF INVESTIGATION
COMMUNICATION MESSAGE FORM

014

PAGE 1 OF 2

DATE 11/27/78	CLASSIFICATION UNCLAS E F T O	PRECEDENCE IMMEDIATE
------------------	----------------------------------	-------------------------

*ST00 RUESONT423 H0014 331180004YET0 1*271734Z NOV 78

▶ START HERE

FM FM DIRECTOR FBI

TO TO S. EMBASSY, GEORGETOWN, GUYANA

FEDERAL GOVERNMENT

ATTENTION: SA ROBERT OGLESBY

BT

UNCLAS E F T O

ALL INFORMATION CONTAINED
HEREIN IS UNCLASSIFIED
DATE 9/25/92 BY 1648 DCA/led

RYMUR

DISASTER TEAM AT DOVER AIR FORCE BASE IN RECEIPT OF
 INFORMATION THAT GUYANESE AUTHORITIES HAVE INKED FINGERPRINT
 IMPRESSIONS OF ALL JONESTOWN SETTLERS. DISASTER SQUAD HAS
 BEEN TOLD GUYANESE AUTHORITIES RELUCTANT TO TURN THESE RECORDS
 OVER. DESTRUCTION TEAM DESPERATELY NEEDS THESE FINGERPRINT CARDS
 TO IDENTIFY DEAD. GUYANESE AUTHORITIES SHOULD HAVE IMMEDIATE
 CONTACT TO ASCERTAIN IF THESE RECORDS EXIST. ASSURE GUYANESE
 AUTHORITIES THAT THE RECORDS WILL BE IMMEDIATELY RETURNED WHEN
 THE IDENTIFICATION PROCESS IS COMPLETED. IN LIEU OF ACTUAL
 RECORDS, COPIES MAY BE UTILIZED PROVIDED THEY SHOW SUFFICIENT
 RIDGE DETAIL TO MAKE IDENTITIES. IDENTIFICATION DIVISION, IF

DO NOT TYPE PAST THIS LINE

DO NOT TYPE MESSAGE BELOW THIS LINE

APPROVED BY <i>[Signature]</i>	DRAFTED BY RDS/RAK f3f	DATE 11/27/78	ROOM 5015/6	TELE EXT. 4190
-----------------------------------	---------------------------	------------------	----------------	-------------------

- 1 - MR.
- 1 - MR.

FEDERAL BUREAU OF INVESTIGATION
COMMUNICATIONS SECTION

NOV 27 1978
1759
TELETYPE

DO NOT FILE WITHOUT COMMUNICATIONS STAMP

89-4286-487

16 NOV 29 1978

b6
b7c

58 NOV 30 1978

DEPARTMENT OF JUSTICE
FEDERAL BUREAU OF INVESTIGATION
COMMUNICATION MESSAGE FORM

PAGE 2

CONTINUATION SHEET

PAGE TWO DE RUEHFB 0014 UNCLAS E F T O

COPIES CAN BE OBTAINED, DESIRES TO SEND TO NON-AGENT FINGER-
 20 PRINT TECHNICIANS TO GUYANA WITH APPROPRIATE PHOTOGRAPHIC EQUIP-
 18 MENT TO OBTAIN COPIES SUITABLE FOR IDENTIFICATION PURPOSES.
 THESE ARE NON-INVESTIGATIVE PERSONNEL AND THEIR ONLY PURPOSE
 16 IN GUYANA WOULD BE TO COPY THESE FINGERPRINT RECORDS. PLEASE
 STRESS TO GUYANA AUTHORITIES THE NECESSITY OF OBTAINING THESE
 14 FINGERPRINT IN ORDER TO IDENTIFY THE DEAD. THIS REQUEST IS FOR
 HUMANITARIAN PURPOSES. *W*

12 BT

10 ¶

8

6

4

2

DO NOT TYPE PAST THIS LINE

DO NOT TYPE MESSAGE BELOW THIS LINE

050

DEPARTMENT OF JUSTICE
FEDERAL BUREAU OF INVESTIGATION
COMMUNICATION MESSAGE FORM

PAGE 1 OF 2

DATE 11/27/78 CLASSIFICATION UNCLAS E F T O PRECEDENCE PRIORITY

FM SFHQ PP SFQDE HQ HQ050 3315HQYEP 272146Z NOV 78

START HERE

FM DIRECTOR FBI {89-4286}

TO TO FBI SAN FRANCISCO {89-250} PRIORITY

BT

14 UNCLAS E F T O

RYMUR

ALL INFORMATION CONTAINED
HEREIN IS UNCLASSIFIED
DATE 9/25/92 BY 1048 DCM/julan

12 REFERENCE BUREAU TELCAL TO ASAC, SAN FRANCISCO. 11/27/78 (u)
THIS CONFIRMS REFERENCED TELCAL AT WHICH TIME SAN FRANCISCO
10 WAS ADVISED THAT ON NOVEMBER 24, 1978, FBIHQ ACCEPTED AN 8X11
INCH SEALED MANILLA ENVELOPE STAMPED CONFIDENTIAL WHICH CON-
8 TAINED A NOTE FOUND ON THE BODY OF REVEREND JAMES JONES. THE
ENVELOPE WAS OPENED AT FBIHQ AND IT CONTAINED A SMALLER MANILLA
6 ENVELOPE WITHIN IT WAS A WHITE LETTER-SIZED ENVELOPE. THE
WHITE ENVELOPE CONTAINED A FOLDED NOTE. THE BUREAU TYPED
4 VERSION OF THIS NOTE IS AS FOLLOWS: (u)

DO NOT TYPE PAST THIS LINE

"DAD DAD I SEE NO WAY OUT - I AGREE WITH YOUR
2 DECISION - I FEAR ONLY THAT WITHOUT YOU THE WORLD MAY NOT MAKE
IT TO COMMUNISM - [SH. (WORD BELIEVED TO BE FISH OR TISH)] (u)

DO NOT TYPE MESSAGE BELOW THIS LINE

APPROVED BY [Signature] DRAWN BY [Signature] DATE 11/27/78 ROOM 5015/6 TELE EXT. 4190

REC-126

89-4286-488

- 1 - MR. ADAMS
- 1 - MR. MOORE
- 1 - MR. INGRAM
- 1 - MR. GOW
- 1 - MR. [Redacted]
- 1 - MR. [Redacted]

FEDERAL BUREAU OF INVESTIGATION
COMMUNICATIONS SECTION

NOV 27 1978
TELETYPE

16 NOV 29 1978

58 NOV 30 1978

DO NOT FILE WITHOUT COMMUNICATIONS STAMP

FBI/DOJ

b6
b7c

DEPARTMENT OF JUSTICE
FEDERAL BUREAU OF INVESTIGATION
COMMUNICATION MESSAGE FORM

PAGE 2

CONTINUATION SHEET

▶ PAGE TWO DE HQ 0050 UNCLAS E F T O

FOR MY PART - I AM MORE THAN TIRED OF THIS WRETCHED, MERCILESS
20 PLANET & THE HELL IT HOLDS FOR SO MANY MASSES OF BEAUTIFUL
18 PEOPLE - THANK YOU FOR THE ONLY LIFE IVE KNOWN" (W)

THE BUREAU WILL FORWARD ORIGINAL NOTES AND APPROPRIATE
16 302'S AS WELL AS A ZEROX COPY OF THE NOTE BY AIRTEL (W)
SAN FRANCISCO AT SAN FRANCISCO CONDUCT APPROPRIATE
14 INVESTIGATION AND ATTEMPT TO IDENTIFY PT INDIVIDUALS USING
NAME FISH OR TISH. (W)

12 SAN FRANCISCO SHOULD NOTE THAT THE PEOPLES TEMPLE LIST
PROVIDED BY ATTORNEY GARRY LISTS FOLLOWING POSSIBILITIES: (W)

10 NUMBER 141 - PATRICIA PAULINE CARTMELL, AKA TRISHA CARTMELL,
DOB JULY 3, 1954; WHITE FEMALE (W)

8 NUMBER 261 - LEATITIA EIKLER, AKA TISH LEROY,
DOB SEPTEMBER 14, 1930; WHITE FEMALE. (W)

6 NUMBER 417 LETICIA JACKSON, DOB {NONE}; BLACK FEMALE. (W)

ARMED AND DANGEROUS (W)

BT ADMINISTRATIVE NOTE:

ON PAGE 1 PARAGRAPH 2 THE WORD FOLLOWING
COMMUNISM APPEARS TO BE 4 LETTER WORD WITH 1ST LETTER
UNKNOWN.
ON PAGE 2 LINE 3 THE WORD ONLY SHOULD BE
UNDERLINED. PER JCC

DO NOT TYPE PAST THIS LINE

DO NOT TYPE MESSAGE BELOW THIS LINE

(W)

033

DEPARTMENT OF JUSTICE
FEDERAL BUREAU OF INVESTIGATION
COMMUNICATION MESSAGE FORM

DR
JK

PAGE 1 OF 4

DATE NOVEMBER 24, 1978	CLASSIFICATION UNGLAS	PRECEDENCE IMMEDIATE
---------------------------	--------------------------	-------------------------

033000 BA CO SFIDE HQ 0033 32851000 241620Z NOV 78

▶ START HERE

FM DIRECTOR, FBI

TO FBI BALTIMORE {IMMEDIATE}

PERSONAL ATTENTION

TO FBI COLUMBIA {IMMEDIATE}

PERSONAL ATTENTION

TO FBI SAN FRANCISCO {IMMEDIATE}

PERSONAL ATTENTION

BT

UNCLAS

RYMUR.

ALL INFORMATION CONTAINED
HEREIN IS UNCLASSIFIED
DATE 9/25/92 BY 1018 DM/nda

DO NOT TYPE PAST THIS LINE

REBUTELCAL TO COLUMBIA NOVEMBER 23, 1978, AND BUTELCAL TO
BALTIMORE NOVEMBER 24, 1978. (u)

FOR INFORMATION, FBI DISASTER SQUAD IS IN PLACE AT DOVER
AIR FORCE BASE {DAFB}, DOVER, DELAWARE, PROCESSING DECEASED
VICTIMS RETURNING FROM GUYANA. DISASTER SQUAD HAS ADVISED THAT
A "SUICIDE NOTE" WAS DISCOVERED ON THE BODY OF REVEREND JIM
JONES WHICH WAS SEIZED BY A REPRESENTATIVE OF STATE DEPARTMENT

DO NOT TYPE MESSAGE BELOW THIS LINE

APPROVED BY <i>MPS</i>	DRAFTED BY DES:WSS {8}	DATE 11/24/78	ROOM 5030/6	TELE EX 4188
---------------------------	---------------------------	------------------	----------------	-----------------

- 1 - MR. ADAMS
- 1 - MR. MOORE
- 1 - MR. INGRAM
- 1 - MR. GOW
- 1 - MR. [REDACTED]
- 1 - MR. BOYNTON

58 NOV 30 1978

TELETYPE

DEPARTMENT OF JUSTICE
 FEDERAL BUREAU OF INVESTIGATION
 COMMUNICATION MESSAGE FORM

PAGE 2

CONTINUATION SHEET

PAGE TWO DE HQ 0033 UNCLAS

AND FORWARDED TO OSI. BALTIMORE IS TO IMMEDIATELY DISPATCH

20 AGENT PERSONNEL TO DAFB AND SEIZE ALL APPROPRIATE PHYSICAL
 18 EVIDENCE. ABOVE "SUICIDE NOTE" IS TO BE LOCATED AND SEIZED.
 BALTIMORE SECURE BUREAU INTERESTS AT DOVER, DELAWARE. (u)

16 TO DATE, GOVERNMENT OF GUYANA NOW HOLDS 78 SURVIVORS OF
 JONESTOWN INCIDENT. IT IS EXPECTED THAT FIRST GROUP OF
 14 APPROXIMATELY 24 INDIVIDUALS WILL BE RELEASED TO TRAVEL TO THE
 UNITED STATES ON NOVEMBER 24, 1978, AND WILL COMPRISE THOSE
 12 CONSIDERED "NON-PROBLEM" AND VERY ELDERLY. REMAINING SURVIVORS
 CONTINUE UNDER INVESTIGATION AND ARE BEING DETAINED IN GUYANA. (u)

10 STATE DEPARTMENT HAS ADVISED THAT ALL RETURNING AMERICANS
 WILL BE PROCESSED THROUGH CHARLESTON AIR FORCE BASE (CAFB),
 8 CHARLESTON, SOUTH CAROLINA, ON EITHER FRIDAY OR SATURDAY NEXT.
 THE DEPARTMENT OF HEALTH, EDUCATION, AND WELFARE (HEW) WILL
 6 PROVIDE FOOD, HOUSING, CLOTHING AND MEDICAL CARE IMMEDIATELY
 FOLLOWING THE ARRIVAL OF SURVIVORS. HEW WILL RENT A MOTEL FOR
 4 THE PURPOSE OF ALLOWING SURVIVORS TO TAKE CARE OF IMMEDIATE
 PERSONAL NEEDS AND THEREAFTER SURVIVORS WILL BE AVAILABLE
 2 INDIVIDUALLY IN THEIR MOTEL ROOMS FOR INTERVIEW BY THE FBI.
 FOLLOWING INTERVIEWS, HEW WILL PROCESS ALL INDIVIDUALS THROUGH

DO NOT TYPE MESSAGE BELOW THIS LINE

DO NOT TYPE PAST THIS LINE

DEPARTMENT OF JUSTICE
FEDERAL BUREAU OF INVESTIGATION
COMMUNICATION MESSAGE FORM

PAGE

3

CONTINUATION SHEET

PAGE THREE DE HQ 0033 UNCLAS

CUSTOMS AND IMMIGRATION AND THEREAFTER PROVIDE FOR THEIR

20 REUNIFICATION WITH THEIR FAMILIES.

18 COLUMBIA IS TO INSURE THAT A VIABLE CONTINGENCY PLAN IS
DEVELOPED WHICH SHOULD INCLUDE REPRESENTATIVES OF U.S. SECRET
16 SERVICE {USSS}, HEW, MILITARY, STATE DEPARTMENT, U. S. MARSHALS
SERVICE, AND LOCAL AUTHORITIES. COLUMBIA SHOULD INSURE THE
14 PRESENCE OF SUFFICIENT SA MANPOWER TO PROMPTLY INTERVIEW ALL
RETURNING AMERICANS IN A SECURE ATMOSPHERE AT THE SELECTED
12 MOTEL. THIS OPERATION IS TO BE CONSIDERED A CRITICAL PHASE OF
A MAJOR ONGOING LAW ENFORCEMENT ACTION AND, AS SUCH, ALL
10 UNAUTHORIZED PERSONS INCLUDING REPRESENTATIVES OF THE NEWS MEDIA
ARE TO BE BARRED FROM THE AREA SURROUNDING THE MOTEL. (u)

8 COLUMBIA IS TO INSURE THAT LEGITIMATE INTERESTS OF THE
USSS ARE ACCOMMODATED WHICH WOULD INCLUDE ANY ALLEGATIONS THAT
6 ACTS OF VIOLENCE BY PEOPLES TEMPLE MEMBERS MAY BE CARRIED OUT
IN THE FUTURE AGAINST U. S. PUBLIC OFFICIALS. (u)

4 COLUMBIA INSURE THAT ALL INTERVIEWS THOROUGHLY DEVELOP BUT
NOT BE LIMITED TO THE FACTS SURROUNDING THE ASSASSINATION OF
2 CONGRESSMAN RYAN AND HIS PARTY AND ANY CONSPIRACY WHICH MAY
EXIST IN BOTH THE UNITED STATES AND GUYANA. COLUMBIA PROMPTLY (u)

DO NOT TYPE MESSAGE BELOW THIS LINE

DO NOT TYPE PAST THIS LINE

DEPARTMENT OF JUSTICE
FEDERAL BUREAU OF INVESTIGATION
COMMUNICATION MESSAGE FORM

PAGE 4

CONTINUATION SHEET

PAGE FOUR DE HQ 0033 UNCLAS

20 SUBMIT FD-302S REFLECTING RESULTS OF INTERVIEWS CONDUCTED TO
SAN FRANCISCO AND TO FBIHQ. (u)

18 THE COLUMBIA DIVISION OPERATION IS TO BE HANDLED UNDER
THE PERSONAL DIRECTION OF THE SAC. (u)

16 SAN FRANCISCO IMMEDIATELY COORDINATE WITH THE U. S.
ATTORNEY'S OFFICE AND DETERMINE IF IT IS DESIRED THAT SUBPOENAS
14 BE ISSUED FOR INDIVIDUALS RETURNING AT CAFB. IF SUBPOENAS ARE
FORTHCOMING, THEY SHOULD BE IMMEDIATELY ISSUED AND HAND CARRIED
12 TO CAFB FOR SERVICE BY FBI AGENTS AT TIME OF INTERVIEW. (u)

BT

10

8

6

4

2

DO NOT TYPE PAST THIS LINE

DO NOT TYPE MESSAGE BELOW THIS LINE

040

DEPARTMENT OF JUSTICE
FEDERAL BUREAU OF INVESTIGATION
COMMUNICATION MESSAGE FORM

PAGE 1 OF	CLASSIFICATION	PRECEDENCE
DATE	UNCLAS	IMMEDIATE
NOVEMBER 24, 1978		

FM DIRECTOR FBI HQ 0040 328544YU0 241206Z NOV 78

START HERE

FM DIRECTOR FBI
TO TO FBI WASHINGTON FIELD IMMEDIATE

ALL INFORMATION CONTAINED
HEREIN IS UNCLASSIFIED
DATE 9/25/92 BY 1048 DMJ/udm

BT

14 UNCLAS

RYMUR

12 REBUTELCALL TO SUPERVISOR [] WASHINGTON FIELD. (u)
[] OFFICE OF THE VICE PRESIDENT, ADVISED

10 ANTHONY KATSARIS RETURNING UNITED STATES FROM SAN JUAN ARRIVING
THIS DATE DULLES INTERNATIONAL AIRPORT. [] FEARS FOR

8 SAFETY OF KATSARIS. [] STATES [] TELEPHONE
[] HAS INFORMATION REGARDING THREATS TO KATSARIS.

6 WASHINGTON FIELD IMMEDIATELY CONTACT [] REGARDING THESE
THREATS. SUTEL. (u)

4 BT

3

2

REC-126

89-4286-490

6 NOV 28 1978

DO NOT TYPE MESSAGE BELOW THIS LINE

APPROVED BY	DRAFTED BY	DATE	ROOM	TELE EXT.
[Signature]	RDS/HJS {8}	LL/24/78	5030/6	4188

- 1 - MR. ADAMS [Signature]
- 1 - MR. MOORE
- 1 - MR. INGRAM
- 1 - MR. GOW [Signature]
- 1 - MR. []
- 1 - MR. []

FEDERAL BUREAU OF INVESTIGATION
COMMUNICATIONS SECTION

NOV 24 1978
176A
TELETYPE

DO NOT TYPE PAST THIS LINE

b6
b7c

58 NOV 30 1978

048

DEPARTMENT OF JUSTICE
FEDERAL BUREAU OF INVESTIGATION
COMMUNICATION MESSAGE FORM



A JK
P TK

PAGE 1 OF 3	
DATE NOVEMBER 24, 1978	CLASSIFICATION UNCLAS
PRECEDENCE IMMEDIATE	

FD4800 SF ME COMDE HQ 0048 3284HZNR UUUU00 241725Z NOV 78

FM DIRECTOR FBI (89-4286)
 TO FBI SAN FRANCISCO IMMEDIATE
 FBI MEMPHIS IMMEDIATE
 14 FBI COLUMBIA IMMEDIATE

ALL INFORMATION CONTAINED
 HEREIN IS UNCLASSIFIED
 DATE 9/25/92 BY 1068 OCM/rdm

BT

12 UNCLAS
 RYMUR

10 IN VIEW OF THE FACT THAT ATTORNEYS CHARLES E. GARRY AND
 MARK LANE WERE PRESENT AT JONESTOWN, GUYANA WHEN CONGRESSMAN
 8 LEO J. RYAN WAS ASSASSINATED AND BECAUSE BOTH PARTICIPATED IN
 NEGOTIATIONS WITH THE REVEREND JIM JONES AND THE CONGRESSMAN'S
 6 STAFF PRIOR TO CONGRESSMAN RYAN'S TRIP TO GUYANA, AS WELL AS
 THE FACT THAT MARK LANE STATED IN INTERVIEWS TO NEWS MEDIA THAT
 4 HE WARNED THE CONGRESSMAN OF POTENTIAL VIOLENCE POSSIBILITY,
 BOTH GARRY AND LANE ARE TO BE INTERVIEWED BY THE FBI. (u)

2 AVAILABLE INFORMATION INDICATES GARRY IS AT HIS RESIDENCE
 AT SAN FRANCISCO AND LANE IS AT HIS MEMPHIS, TENNESSEE

DO NOT TYPE MESSAGE BELOW THIS LINE

APPROVED BY <u>DWM/LFS</u>	DRAFTER BY <u>LFS/HJS (8)</u>	DATE <u>11/24/78</u>	ROOM <u>5030/6</u>	TELE EXT. <u>4188 6</u>	NOV 23 1978
-------------------------------	----------------------------------	-------------------------	-----------------------	----------------------------	-------------

- 1 - MR. ADAMS
- 1 - MR. MOORE
- 1 - MR. INGRAM
- 1 - MR. GOW
- 1 - MR. []
- 1 - MR. []
- 1 - MR. []

REC-126
 89-4286-49!
 TELETYPE

SEE NOTE PAGE FOUR

58 NOV 30 1978

DO NOT TYPE PAST THIS LINE

b6
b7c

DEPARTMENT OF JUSTICE
 FEDERAL BUREAU OF INVESTIGATION
 COMMUNICATION MESSAGE FORM

PAGE 2

CONTINUATION SHEET

PAGE TWO REDE HQ 0048 UNCLAS

RESIDENCE. SAN FRANCISCO SHOULD IMMEDIATELY CONTACT U. S.
 20 ATTORNEY {USA}, SAN FRANCISCO AND ADVISE HIM OF OUR INTENTION
 18 TO INTERVIEW GARRY AND LANE. THE USA SHOULD BE ASKED IF HE
 DESIRES TO SUBPOENA BOTH MEN BEFORE A FEDERAL GRAND JURY. IF
 16 SO, OBTAIN SUBPOENAS FOR GARRY AND LANE FOR SERVICE BY INTER-
 VIEWING AGENTS, FORWARDING THE APPROPRIATE SUBPOENA TO THE
 14 MEMPHIS DIVISION FOR LANE. THE SUBPOENAS SHOULD BE SERVED AT
 THE TIME GARRY AND LANE ARE INTERVIEWED. SHOULD USA NOT DESIRE
 12 TO SUBPOENA GARRY AND LANE, SAN FRANCISCO SHOULD SUTEL MEMPHIS
 AND FBIHQ. THE BUREAU WILL THEN PROVIDE APPROPRIATE BACKGROUND
 10 FOR LANE'S INTERVIEW TO MEMPHIS, AND MEMPHIS AND SAN FRANCISCO
 WILL BE INSTRUCTED TO INITIATE AN IMMEDIATE INTERVIEW OF THE
 8 ABOVE ATTORNEYS. (u)

SAN FRANCISCO SHOULD IMMEDIATELY DETERMINE FROM USA IF HE
 6 DESIRES THOSE SURVIVORS WHO ARE RETURNING TO THE UNITED STATES
 AND ARE TO BE INTERVIEWED AT CHARLESTON, SOUTH CAROLINA IN THE
 4 NEAR FUTURE, BE SUBPOENAED. IF SO, OBTAIN SUBPOENAS FOR THESE
 PERSONS FROM USA FOR SERVICE IN CHARLESTON, SOUTH CAROLINA.
 2 BUREAU AUTHORITY GRANTED FOR TRAVEL OF SAN FRANCISCO AGENT TO
 CHARLESTON, SOUTH CAROLINA SHOULD USA DESIRE SUBPOENAS AS PER

DO NOT TYPE MESSAGE BELOW THIS LINE

DO NOT TYPE PAST THIS LINE

DEPARTMENT OF JUSTICE
FEDERAL BUREAU OF INVESTIGATION
COMMUNICATION MESSAGE FORM

PAGE 3

CONTINUATION SHEET

PAGE THREE DE HQ 0048 UNCLAS

ABOVE. COLUMBIA AND MEMPHIS ADVISED FOR INFORMATION.

ARMED AND DANGEROUS. (u)

20
18 BT
16
14
12
10
8
6
4
2

DO NOT TYPE PAST THIS LINE

DO NOT TYPE MESSAGE BELOW THIS LINE

NOTE: Above alerts Memphis to interview Mark Lane, Attorney for Peoples Temple, and instructs San Francisco to contact USA regarding any subpoena he may desire to serve on Lane and co-counsel Charles E. Garry. Should subpoena desired, same will be served by interviewing Agents at time of interview. Should no subpoena be requested, receiving offices will be instructed to proceed with interviews upon receipt of suitable background. San Francisco also instructed to contact USA regarding subpoena of survivors who will shortly be interviewed at Charleston, South Carolina, and Bureau authority granted for travel of Agent to deliver subpoena if necessary. San Francisco instructed to interview Charles E. Garry, co-counsel for Mark Lane.

030

Handwritten notes and initials at top left.

MESSAGE RELAY VIA TELETYPE

Date 11/27/78

PRECEDENCE: IMMEDIATE
 PRIORITY
 ROUTINE

CLASSIFICATION: TOP SECRET
 SECRET
 CONFIDENTIAL
 UNCLASSIFIED

FIELD AND LEGAT MESSAGES ONLY CLEAR EFTO

FM: DIRECTOR
TO:

COLUMBIA

ALL INFORMATION CONTAINED
HEREIN IS UNCLASSIFIED
DATE 9/25/92 BY 10480 km/whd

- Attorney General
- Deputy Attorney General
 - Attn: Emergency Programs Center
- Assistant Attorney General, Civil Rights Div.
- Assistant Attorney General, Criminal Div.
 - Attn: Internal Security Section
 - Attn: General Crimes Section
- Immigration and Naturalization Service
- U. S. Marshal's Service
- U. S. Secret Service (PID)
- Director, CIA
- Secretary of State
- Department of Treasury
 - Attn: U. S. Customs
- Department of Treasury
 - Attn: Bureau of Alcohol Tobacco & Firearms

- Drug Enforcement Administration
- Energy Research and Development Administration
- U. S. Postal Service
- National Aeronautics & Space Adm.
- Department of Transportation
 - Attn: Director of Security
- Federal Aviation Administration
- Department of the Air Force (AFOSI)
- Department of the Army
- Naval Investigative Service
- National Security Agency (DIRNSA/NSOC, (Attn: SOO))
- Commandant, U. S. Coast Guard
- Director, Defense Intelligence Agency

- The President
- White House Situation Room
 - Attn:
- The Vice President
 - Attn:

Handwritten circled mark.

(SUBJECT (TEXT BEGINS NEXT PAGE):

SEE ATTACHED

Foreign Liaison Unit

- Route through for review
- Cleared telephonically with _____

- Assoc. Dir. _____
- Dep. AD Adm. _____
- Dep. AD Inv. _____
- Asst. Dir.:
 - Adm. Servs. _____
 - Crim. Inv. _____
 - Ident. _____
 - Intell. _____
 - Laboratory _____
 - Legal Coun. _____
 - Plan. & Insp. _____
 - Rec. Mgnt. _____
 - Tech. Servs. _____
 - Training _____
 - Public Affs. Off. _____
 - Telephone Rm. _____
 - Director's Sec'y _____

ORIGINATOR KMR

RM 5027 EXT 2805

REC-126 89-4286-492

NOV 29 1978

Handwritten date: NOV 25 1978

Handwritten box with '6' next to it.

b6
b7c

SPECIAL

SPC-909 (757)

Assoc. Dir.	/
Dep. AD Adm.	/
Dep. AD Inv.	/
Asst. Dir.:	
Adm. Serv.	/
Crim. Inv.	/
Ident.	/
Intell.	/
Laboratory	/
Legal Coun.	/
Plan. & Insp.	/
Rec. Mgnt.	/
Tech. Servs.	/
Training	/
Public Affs. Off.	/
Telephone Rm.	/
Director's Sec'y	/

SFO 848 3320034

28 Nov 78 00 33z

OO HQ

RECEIVED
FEDERAL BUREAU
OF INVESTIGATION
COMMUNICATIONS SECTION
MB

DE SF 0013

O 280035Z NOV 78

FM SAN FRANCISCO (8-250) (P) (SQ. 10)

TO DIRECTOR (8-4286) IMMEDIATE

BT

UNCLAS
RYMUR

BY FACSIMILE, THE SAN FRANCISCO OFFICE ON THE NIGHT OF NOVEMBER 26-27, 1978, FURNISHED THE LIST OF ALL PEOPLE'S TEMPLE (PT) MEMBERS THAT HAD GONE TO GUYANA. THIS LIST COMPILED BY ATTORNEY CHARLES GARRY, SAN FRANCISCO. (u)

ON PAGE 48, THE LAST NAME, NUMBER 960, SHOULD READ AS FOLLOWS: (u)

SMITH, KEVIN DEANE, MAY 21, 1961, B. M. (u)

~~BUREAU ADD TO COPIES.~~ (u)

"ARMED AND DANGEROUS. SUICIDAL TENDENCIES" (u)

BT

g

0: M/1/1/1
A H
P



012

MESSAGE RELAY VIA TELETYPE

Date 11/27/78

PRECEDENCE: IMMEDIATE
 PRIORITY
 ROUTINE

CLASSIFICATION: TOP SECRET
 SECRET
 CONFIDENTIAL
 UNCLASSIFIED

FIELD AND LEGAT MESSAGES
ONLY CLEAR EFTO

FM: DIRECTOR
TO:

ALL INFORMATION CONTAINED
HEREIN IS UNCLASSIFIED
DATE 9/27/92 BY 1046 DCA/nda

COLUMBIA

- Attorney General
- Deputy Attorney General
- Attn: Emergency Programs Center
- Assistant Attorney General, Civil Rights Div.
- Assistant Attorney General, Criminal Div.
 - Attn: Internal Security Section
 - Attn: General Crimes Section
- Immigration and Naturalization Service
- U. S. Marshal's Service
- U. S. Secret Service (PID)
- Director, CIA
- Secretary of State
- Department of Treasury
 - Attn: U. S. Customs
- Department of Treasury
 - Attn: Bureau of Alcohol Tobacco & Firearms

- Drug Enforcement Administration
- Energy Research and Development Administration
- U. S. Postal Service
- National Aeronautics & Space Adm.
- Department of Transportation
 - Attn: Director of Security
- Federal Aviation Administration
- Department of the Air Force (AFOSI)
- Department of the Army
- Naval Investigative Service
- National Security Agency
 - (DIRNSA/NSOC (Attn: SOO))
- Commandant, U. S. Coast Guard
- Director, Defense Intelligence Agency

- The President
- White House Situation Room
 - Attn:
- The Vice President
 - Attn:



REC-123

89-4286-493

(SUBJECT (TEXT BEGINS NEXT PAGE):

0

Foreign Liaison Unit

- Route through for review
 - Cleared telephonically
- with _____

UNKNOWN SUBJECT; CONGRESSMAN LEO J. RYAN -
DECEASED, VICTIM, CONGRESSIONAL ASSASSINATION

STATUTE

- Sec. Dir. _____
- Dep. AD Adm. _____
- Dep. AD Inv. _____
- Dir. _____
- Adm. Servs. _____
- Ident. _____
- Intell. _____
- Lab. _____
- Legal Coun. _____
- Plan. & Insp. _____
- Rec. Mgmt. _____
- Tech. Servs. _____
- Training _____
- Off. Affs. _____
- Director's Sec'y _____

ORIGINATOR KMR RM 5027 EXT 2805

NOV 29 1978



b6
b7c

01492 CG

NOV 30 1978

Assoc. Dir.	
Dep. AD Adm.	
Dep. AD Inv.	
Asst. Dir.:	
Adm. Serv.	
Crim. Inv.	
Ident.	
Intell.	
Laboratory	
Legal Coun.	
Plan. & Insp.	
Rec. Mgnt.	
Tech. Servs.	
Training	
Public Affs. Off.	
Telephone Rm.	
Director's Sec'y	

77 Nov 78 22 35 z

RECEIVED
FEDERAL BUREAU OF INVESTIGATION
COMMUNICATIONS SECTION

SJ0367 331221Z
OO HI SF
DE SJ 0003
O 27: 21Z NOV 78
FM SAN JUAN (89-123)
TO DIRECTOR (89-4286)
SAN FRANCISCO (89-250)
BT
E F T O

~~IMMEDIATE~~
IMMEDIATE



(X) VERNON DEAN GOSNEY, WHITE MALE, DATE OF BIRTH MARCH 19, 1953, PLACE OF BIRTH ALBANY, CALIFORNIA, 6 FEET TALL, 145 POUNDS, BROWN HAIR AND EYES, TATTOO OF FLOWER, RIGHT UPPER ARM (X), PARTIALLY INTERVIEWED NOVEMBER 27, 1978, AT ROOSEVELT ROADS NAVAL HOSPITAL (RRNH), PUERTO RICO. INTERVIEW LASTED A SHORT PERIOD OF TIME AS INTERVIEW HAD TO BE TERMINATED DUE TO GOSNEY'S CONDITION AND REQUEST. (U)

By FBI SAN JUAN.

b6
b7c

~~BUREAU AND SAN FRANCISCO SHOULD NOTE~~ GOSNEY WOUNDED SEVERELY DURING JONESTOWN INCIDENT RECEIVING WOUNDS TO THE (U)

0-7310
USSS + ST
CO. 11/27/78
SEC. [Signature]

TELETYPED TO:
SF

NOV 51 12 12
2

PAGE TWO (89-123) E F T O

LIVER, ABDOMEN, SPLEEN AND DIAPHRAM AND REMAINS IN THE INTENSIVE CARE UNIT, RRNH. (u)

EXTENSIVE INTERVIEW IS BEING CONDUCTED HOWEVER FOR ONLY BRIEF PERIOD EACH DAY. (u)

DURING INTERVIEW THIS DATE GOSNEY ADVISED THAT MEMBERS OF JONESTOWN CAMP "PROGRAMED" TO STRICKLY OBEY JONES' COMMANDS. DISCIPLINARY ACTION TAKEN BY JONES FOR THOSE WHO DISOBEY INCLUDED BEATINGS, HUMILIATION, SEDATION BY USE OF DRUGS. (u)

INTERVIEW ALSO DETERMINED THAT A SECURITY SQUAD WAS MAINTAINED BY JONES AND FREQUENTLY RECEIVED FIREARMS TRAINING. FIREARMS WERE SMUGGLED INTO GUYANA BY NUMEROUS FOLLOWERS OF JONES BROKEN DOWN INTO PARTS. JONES MAINTAINED POSSIBLY 50 WEAPONS INCLUDING RIFLES AND HANDGUNS. SECURITY FORCE WAS MADE UP OF STEVE JONES, TIM JONES (WHITE MALE), TIM JONES (BLACK MALE), LOU JONES, JIMMY JONES, JR., CALVIN DOUGLAS, JOHNNY COBB JONES, JOHNNY JONES, JR., DOUG SANDERS. JOE WILSON WHOSE DESCRIPTION HAS BEEN PREVIOUSLY FURNISHED WAS ACTING HEAD OF SECURITY. (u)

INTERVIEW ALSO DETERMINED THAT "TRAITORS" TO THE JONES MOVEMENT WOULD BE KILLED. (u)

3

PAGE THREE (89-123) E F T O

GOSNEY IDENTIFIED (X) STANLEY GIEG, WHITE MALE, BLOND HAIR, 18 YEARS OF AGE, 5'8" - 5'9" TALL, APPROXIMATELY 160 POUNDS, SHORT - MUSCULAR - HAIRY (X), AS BEING DRIVER OF TRUCK THAT TRANSPORTED RYAN AND GROUP FROM CAMP TO AIRSTRIP ON DAY OF SHOOTING. GOSNEY ALSO ADVISED THAT GIEG, AFTER DROPPING OFF THE GROUP LEFT THE AIRSTRIP AND RETURNED ON THE TRACTOR THAT CONTAINED THE ATTACKERS. GIEG WAS SEEN WITH A WEAPON AND ENGAGED IN SHOOTING. BUREAU AND SAN FRANCISCO SHOULD NOTE THAT VIDEO TAPE MADE BY NBC CAMERA MAN REFLECTS AN INDIVIDUAL SIMILAR IN DESCRIPTION TO GIEG IN THE GROUP OF JONESTOWN INHABITANTS WHICH INITIALLY MET THE RYAN GROUP UPON ITS ARRIVAL AT PORT KAITUM. (u)

GOSNEY SUSPECTED TROUBLE BECAUSE THE TRUCK WAS DELAYED LEAVING JONESTOWN, AND THE FACT THAT LAYTON AND JOE WILSON ACCOMPANIED THEM. (u)

GOSNEY ALSO ADVISED IT IS HIS BELIEF THAT ATTACK WAS PLANNED DURING ASSEMBLY OF JONES' FOLLOWERS PRIOR TO THE TRUCK LEAVING JONESTOWN. AN ASSEMBLY WAS ALWAYS HELD WHEN SOME TYPE OF ACTION TO BE TAKEN BY JONES TO RESOLVE ANY TYPE OF PROBLEM. (u)

PAGE FOUR (89-123) E F T O

PEV SAN JUAN WILL CONTINUE INTERVIEW OF GOSNEY AND FURNISH
SUMMARIES OF INFORMATION OBTAINED FROM THIS WITNESS. *(u)*

ARMED AND DANGEROUS - SUICIDAL TENDANCIES. *(u)*

BT

S

029

AK-1A
0
A
P

MESSAGE RELAY VIA TELETYPE

Date 11/27/78

PRECEDENCE: IMMEDIATE
 PRIORITY
 ROUTINE

CLASSIFICATION: TOP SECRET
 SECRET
 CONFIDENTIAL
 UNCLASSIFIED

FIELD AND LEGAT MESSAGES
ONLY CLEAR EFTO
XX

FM: DIRECTOR
TO:

ALL INFORMATION CONTAINED
HEREIN IS UNCLASSIFIED
DATE 9/25/92 BY 1048 DM/udm
Oppg 2

COLUMBIA

- Attorney General
- Deputy Attorney General
- Attn: Emergency Programs Center
- Assistant Attorney General, Civil Rights Div.
- Assistant Attorney General, Criminal Div.
- Attn: Internal Security Section
- Attn: General Crimes Section
- Immigration and Naturalization Service
- U. S. Marshal's Service
- U. S. Secret Service (PID)
- Director, CIA
- Secretary of State
- Department of Treasury
- Attn: U. S. Customs
- Department of Treasury
- Attn: Bureau of Alcohol Tobacco & Firearms

- Drug Enforcement Administration
- Energy Research and Development Administration
- U. S. Postal Service
- National Aeronautics & Space, Adm.
- Department of Transportation
- Attn: Director of Security
- Federal Aviation Administration
- Department of the Air Force (AFOSI)
- Department of the Army
- Naval Investigative Service
- National Security Agency (DIRNSA/NSOC (Attn: SOO))
- Commandant, U. S. Coast Guard
- Director, Defense Intelligence Agency

- The President
- White House Situation Room
- Attn:
- The Vice President
- Attn:
-
-

Q

(SUBJECT (TEXT BEGINS NEXT PAGE):

Foreign Liaison Unit

- Route through for review
 - Cleared telephonically
- with _____

SEE ATTACHED REC-126

89-4286-494

- Assoc. Dir. _____
- Dep. AD Adm. _____
- Dep. AD Inv. _____
- Asst. Dir.:
- Adm. Servs. _____
- Crim. Inv. _____
- Ident. _____
- Intell. _____
- Laboratory _____
- Legal Coun. _____
- Plan. & Insp. _____
- Rec. Mgnt. _____
- Tech. Servs. _____
- Training _____
- Public Affs. Off. _____
- Telephone Rm. _____
- Director's Sec'y _____

ORIGINATOR KMR RM 5027 EXT. 2805

NOV 29 1978

0350 TR
NOV 29 1978

6

b6
b7c

211
NOV 30 1978
MAIL ROOM

Assoc. Dir.	✓
Dep. AD Adm.	✓
Dep. AD Inv.	✓
Asst. Dir.:	
Adm. Serv.	✓
Crim. Inv.	✓
Ident.	✓
Intell.	✓
Laboratory	✓
Legal Coun.	✓
Plan. & Insp.	✓
Rec. Mgmt.	✓
Tech. Servs.	✓
Training	✓
Public Affs. Off.	✓
Telephone Rm.	✓
Director's Sec'y	✓

SF0846 3310016Z

OO HQ HO LA NY SC SL WF

DE SF 008

O 270007Z NOV 7

28 Nov 78 00 23z

RECEIVED
FEDERAL BUREAU
OF INVESTIGATION
COMMUNICATIONS SECTION

FM SAN FRANCISCO (89-250) (P) (SQ. 10)

TO DIRECTOR (89-4286) IMMEDIATE

HOUSTON IMMEDIATE

LOS ANGELES (89-436) IMMEDIATE (LA VIA FBIHQ)

NEW YORK (89-495) IMMEDIATE (NY VIA FBIHQ)

SACRAMENTO (89-191) IMMEDIATE (~~SAC VIA FBIHQ~~)

ST LOUIS IMMEDIATE

WFO (89-750) IMMEDIATE (WFO VIA FBIHQ)

BT

UNCLAS

RYMUR

FOR INFORMATION PURPOSES, THE FOLLOWING PEOPLE'S
TEMPLE (PT) MEMBERS MAY BE ALLOWED TO PROCEED DIRECTLY FROM
GUYANA TO THEIR RESIDENCES IN THE U.S. WITHIN THE NEXT FEW DAYS.
IN THE EVENT THAT MEMBERS DO TRAVEL DIRECTLY TO THEIR RESIDENCES, (u)

TELETYPED TO:
LA NY WF

2

AGE TWO SF ,;-250 UNCLAS

THEY SHOULD BE LOCATED AND INTERVIEWED AT THE FOLLOWING LOCATIONS, HOWEVER, EVERY EFFORT WILL BE MADE TO OBTAIN ITINERARIES TO HAVE PERSONS INTERVIEWED UPON ARRIVAL AT RESPECTIVE AIRPORTS. (u)

THIS INFORMATION IS NOT TO BE MADE PUBLIC IN VIEW OF SURVIVING MEMBERS' FEAR OF REPRISAL. (u)

SACRAMENTO: EDITH BOGUE, 17 ANCHOR DRIVE, SUISUN, CALIFORNIA; JAMES BOGUE, SAME ADDRESS; JUANITA BOGUE, SAME ADDRESS; TEENA BOGUE, SAME ADDRESS; TOM BOGUE, SAME ADDRESS; HAROLD CORDELL, SAME ADDRESS. (u)

LOS ANGELES: MARION CAMPBELL, 1435 ALVARADO TERRACE, LOS ANGELES, CALIFORNIA, 388-7535; VERSIE CONNESERO, SAME ADDRESS; HENRY CANNON, 3230 JANICE STREET, LONG BEACH, CALIFORNIA; RAY GODSHALK, 103 ROSE LANE, MONTEBELLO, CALIFORNIA; PAUL MC CANN, 4186 FOOTHILL ROAD, CARPENTERIA, CALIFORNIA. (u)

WFO: MADELINE BROOKS, 2039 NEW HAMPSHIRE AVENUE, NW, WASHINGTON, D.C.; BEA ORSOT GRUBBS, SAME AS ABOVE; LAURA JOHNSTON, SAME AS ABOVE. (u)

HOUSTON: DAWN (MITCHELL) GARDFFEY, 5600 N. FREEWAY III, HOUSTON, TEXAS; RUBY JOHNSON, SAME AS ABOVE; GUY MITCHELL, SAME AS ABOVE; LINDA MITCHELL, SAME AS ABOVE. (u)

PAGE THREE SF 89-250 UNCLAS

ST. LOUIS: AARON HENDRICKS, 5535 PERSHING AVENUE,
ST. LOUIS, MO. (u)

NEW YORK: LEE INGRAM, 29 MORE STREET, BROOKLYN,
NEW YORK, (212) 388-1419. (u)

BT

MM0016 3312229

PP HI JK SF KC

DE MM

P 272229Z NOV 78

FM MIAMI (89-179) P

TO DIRECTOR (89-4286) PRIORITY

JACKSONVILLE PRIORITY

SAN FRANCISCO (89-250) PRIORITY

KANSAS CITY PRIORITY

BT

UNCLAS
RYMUR.

27 NOV 78 22 37 z

RECEIVED
FEDERAL BUREAU
OF INVESTIGATION
COMMUNICATIONS SECTION MB

Assoc. Dir.	_____
Dep. AD Adm.	_____
Dep. AD Inv.	_____
Asst. Dir.:	_____
Adm. Serv.	_____
Crim. Inv.	_____
Ident.	_____
Intell.	_____
Laboratory	_____
Legal Coun.	_____
Plan. & Insp.	_____
Rec. Mgnt.	_____
Tech. Servs.	_____
Training	_____
Public Affs. Off.	_____
Telephone Rm.	_____
Director's Sec'y	_____

ALL INFORMATION CONTAINED
HEREIN IS UNCLASSIFIED
DATE 9/25/92 BY 1048 DCM/W



b6
b7C

(Handwritten initials)

RE MIAMI TEL TO THE BUREAU, NOVEMBER 27, 1978, AND
PHILADELPHIA TEL TO THE BUREAU, NOVEMBER 27, 1978. (u)

FOR INFORMATION OF JACKSONVILLE, [REDACTED] HAS
PREVIOUSLY BEEN LOCATED AT KEY WEST, FLORIDA AND INTERVIEWED
REGARDING THIS MATTER. (u)

INVESTIGATION CONTINUING AT MIAMI. (u)

ARMED AND DANGEROUS; SUICIDAL TENDENCIES. (u)

BT

#

REC-126 89-4286-4195

NOV 29 1978

58 DEC 1 1978

(Handwritten initials)

VV FBA324

OO RUEHFB

DE RUESON #3970 3312300

ZNR UUUUU ZZH

O 272235Z NOV 78

FM AMEMBASSY GEORGETOWN

TO RUEHFB/SECSTATE WASHDC IMMEDIATE

BT

UNCLAS GEORGETOWN 3970

FOR FBIHQ

E.O. 115652: N/A

TAGS:

SUBJECT: RYMUR

27 Nov 78 23 10z

FEDERAL BUREAU OF INVESTIGATION COMMUNICATIONS SECTION

ALL INFORMATION CONTAINED HEREIN IS UNCLASSIFIED DATE 9/25/92 BY 1048 DEH/wh

FEDERAL GOVERNMENT

Assoc. Dir.	_____
Dep. AD Adm.	_____
Dep. AD Inv.	_____
Asst. Dir.:	_____
Adm. Serv.	_____
Crim. Inv.	_____
Ident.	_____
In'tel.	_____
Laboratory	_____
Legal Coun.	_____
Plan. & Insp.	_____
Rec. Ment.	_____
Tech. Servs.	_____
Training	_____
Public Affs. Off.	_____
Telephone Rm.	_____
Director's Sec'y	_____

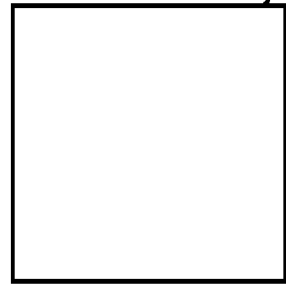

b6 per FBI
b7C

REC-126

89-4286-496

NOV 29 1978

REFERENCE BUREAU TELCALL NOVEMBER 27/1978

✓ 1. GUYANESE POLICE AT GEORGETOWN HAVE POSSESSION OF PHYSICAL EVIDENCE IN THIS MATTER AND ARE PRESERVING IT. REQUEST IS PENDING FOR REPORT SETTING FORTH DETAILS OF CRIME AND AMOUNT OF PHYSICAL EVIDENCE IN POSSESSION OF POLICE.

58 NOV 30 1978

2. CONGRESSMAN RYAN'S BRIEFCASE WAS GIVEN BY DCM RICHARD DWYER TO JAMES SCHALDAERT OF THE HOUSE INTERNAL RELATIONS COMMITTEE.

3. WEAPON USED BY LAYTON WAS GIVEN BY DCM DWYER TO POLICE AT PORT KAITUMA AND BELIEVED TO BE AMONG 32 WEAPONS HELD BY POLICE AT GEORGETOWN.

4. 32 WEAPONS BROUGHT FROM JONESTOWN TO GEORGETOWN AND IN POSSESSION OF POLICE. DETAILS OF THESE WEAPONS PREVIOUSLY FURNISHED FBIHQ.

5. RECORDS AND OTHER PHYSICAL EVIDENCE BROUGHT FROM JONESTOWN AND IN CUSTODY OF U.S. EMBASSY AT GEORGETOWN.

BURKE

BT

#3970

2

Assoc. Dir.	
Dep. AD Adm.	
Dep. AD Inv.	
Asst. Dir.:	
Adm. Serv.	<input checked="" type="checkbox"/>
Crim. Inv.	<input checked="" type="checkbox"/>
Ident.	
Intell.	
Laboratory	
Legal Coun.	
Plan. & Insp.	
Rec. Mgnt.	
Tech. Servs.	
Training	
Public Affs. Off.	
Telephone Rm.	
Director's Sec'y	

N00005 3312201

00 HQ LA SF

DE NO 0005

27 Nov 78 22 10z

RECEIVED
FEDERAL BUREAU
OF INVESTIGATION
COMMUNICATIONS SECTION

0 272158Z NOV 78

FM NEW ORLEANS (89-184)

TO DIRECTOR (89-4286) IMMEDIATE

LOS ANGELES I(89-436) IMMEDIATE

SAN FRANCISCO (89-250) IMMEDIATE

BT

UNCLAS

ALL INFORMATION CONTAINED
HEREIN IS UNCLASSIFIED
DATE 9/25/92 BY 1048 DCM/indm
#284,125 & #284,126

RYMUR

RE BUREAU TELETYPE NOV. 22, 1978. NEW ORLEANS TELCAL OF SA

[redacted] TO LA, SA [redacted] NOV. 27, 1978. (u)

NEWS ACCOUNTS IN NEW ORLEANS HAS GENERATED INFORMATION REGARD-
ING SURVIVORS OF SELIKA PRUDEAUX BORDENAVID, NEGRO FEMALE, DOB JULY
16, 1918, AT PASS CHRISTIAN, MISSISSIPPI. CONTACT WAS ESTABLISHED
WITH [redacted] SISTER OF BORDENAVID, WHO RESIDES AT [redacted]
[redacted] NEW ORLEANS, LA. BORDENAVID ALSO HAS HER MOTHER, LOUISE
PRUDEAUX ALSO RESIDING AT [redacted] IT IS NOTED THAT MRS. (u)

b6
b7c

LE-51

REC-126

89-4286-497

NOV 29 1978

58 NOV 30 1978

PAGE TWO NO 89-184 UNCLAS

PRUDEAUX IS 83 YEARS OF AGE AND EXTREMELY POOR HEALTH. NO INTERVIEW WAS CONDUCTED. (u)

[REDACTED] (SUPRA), ADVISED THAT SELIKA PRUDEAUX BORDENAVD, HAS BEEN RESIDING IN CALIFORNIA FOR APPROXIMATE LAST 20 YEARS.

BORDENAVD HAS A DAUGHTER, SELIKA BATES, RESIDENCE [REDACTED]

LAPUENTE, CALIFORNIA, AREA CODE [REDACTED] BORDENAVD ALSO HAS

A SON EMMANUEL GEORGE BORDENAVD, WHO RESIDES [REDACTED]

LOS ANGELES, CALIFORNIA, TELEPHONE [REDACTED] (u)

MRS. [REDACTED] ADVISED THAT BORDENAVD HAS RESIDED IN GUYANA FOR APPROXIMATE LAST YEAR. HER CORRESPONDENCE WITH BORDENAVD ALWAYS INDICATED THAT BORDENAVD WAS VERY HAPPY DOING MISSIONARY WORK IN THAT COUNTRY. [REDACTED] COULD PROVIDE NO INFORMATION REGARDING ANY VIOLENCE, ANY INFORMATION REGARDING ANY GUNS OR FIREARMS TRAINING. SHE DID STATE THAT OCCASIONALLY HER SISTER WOULD SOLICITE MONEY TO BE SENT TO SUPPORT THEIR OPERATIONS IN GUYANA. (u)

FOR THE ADDITIONAL INFORMATION OF LOS ANGELES, SELIKA BATES (SUPRA) HAS BEEN INTERVIEWED TELEPHONICALLY BY LOCAL NEWS PEOPLE IN NEW ORLEANS. DURING THESE INTERVIEWS MRS. BATES INDICATED THAT SHE WAS VERY UNHAPPY WITH THE FBI. INDICATIONS WERE THAT SHE HAD CONTACTED THE BUREAU IN LOS ANGELES ON SEVERAL OCCASIONS IN THE PAST REGARDING ALLEGED MISTREATMENT AND OTHER ACTS OF VIOLENCE BEING (u)

b6
b7c

PAGE THREE NO 89-184 UNCLAS

CONDUCTED IN CONNECTION WITH THE PEOPLES TEMPLE COMMUNE IN GUYANA. ONE NEWSPAPER ACCOUNT IN NEW ORLEANS SAYS THAT MRS. BATES CRITIZED THE FBI AND U.S. GOVERNMENT FOR NOT DOING SOMETHING AND SHE IS UPSET ABOUT HAVING TO EXPEND HER OWN FUNDS TO IDENTIFY AND RETRIEVE HER MOTHER'S BODY. (u)

INVESTIGATION AT NEW ORLEANS CONTINUES WITH REGARD TO SECOND HAM RADIO OPERATOR WHO WAS IN CONTACT WITH PERSONS IN GUYANA DURING THE SUMMER OF 1978. (u)

ADDITIONALLY, EFFORTS ARE BEING MADE TO INTERVIEW [REDACTED]

[REDACTED] THROUGH HIS BROTHER WHO IS WELL KNOWN TO THE NEW ORLEANS OFFICE. [REDACTED] DAUGHTER WAS ALSO A VICTIM AND [REDACTED] RECEIVED NATIONAL NEWS COVERAGE IN CONNECTION WITH HIS TRAVEL TO GUYANA. (u)

FD-302S WILL FOLLOW. (u)

ARMED AND DANGEROUS. SUICIDAL TENDENCIES. (u)

BT

b6
b7c

3

FEDERAL BUREAU OF INVESTIGATION
FOIPA
DELETED PAGE INFORMATION SHEET

No Duplication Fees are charged for Deleted Page Information Sheet(s).

Total Deleted Page(s) ~ 6

Page 14 ~ Duplicate of serials 391, 480

Page 15 ~ Duplicate

Page 16 ~ Duplicate

Page 17 ~ Duplicate

Page 18 ~ Duplicate

Page 19 ~ Duplicate